

Agilent 4287A RF LCR Meter

Service Manual

Eighth Edition

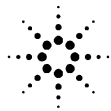

Agilent Technologies

Manufacturing No. 04287-90170

September 2007

Notices

The information contained in this document is subject to change without notice.

This document contains proprietary information that is protected by copyright. All rights are reserved. No part of this document may be photocopied, reproduced, or translated to another language without the prior written consent of Agilent Technologies.

Microsoft®, MS-DOS®, Windows®, Visual C++®, Visual Basic®, VBA® and Excel® are registered

UNIX is a registered trademark in U.S. and other countries, licensed exclusively through X/Open Company Limited.

Portions ©Copyright 1996, Microsoft Corporation. All rights reserved.

© Copyright 2000, 2001, 2004, 2005, 2007 Agilent Technologies

Manual Printing History

The manual's printing date and part number indicate its current edition. The printing date changes when a new edition is printed. (Minor corrections and updates that are incorporated at reprint do not cause the date to change.) The manual part number changes when extensive technical changes are incorporated.

May 2000	First Edition
July 2000	Second Edition
October 2001	Third Edition
November 2004	Fourth Edition
January 2005	Fifth Edition
December 2005	Sixth Edition
July 2007	Seventh Edition
September 2007	Eighth Edition

Safety Summary

The following general safety precautions must be observed during all phases of operation, service, and repair of this instrument. Failure to comply with these precautions or with specific WARNINGS elsewhere in this manual may impair the protection provided by the equipment. Such noncompliance would also violate safety standards of design, manufacture, and intended use of the instrument. Agilent Technologies assumes no liability for the customer's failure to comply with these precautions.

-
- | | |
|-------------|---|
| NOTE | The 4287A complies with INSTALLATION CATEGORY II as well as POLLUTION DEGREE 2 in IEC61010-1. The 4287A is an INDOOR USE product. |
|-------------|---|
-
- | | |
|-------------|--|
| NOTE | The LEDs in the 4287A are Class 1 in accordance with IEC60825-1, CLASS 1 LED PRODUCT |
|-------------|--|
-
- | | |
|-------------|--|
| NOTE | This equipment is MEASUREMENT CATEGORY I (CAT I). Do not use for CAT II, III, or IV. |
|-------------|--|
-
- | | |
|-------------|---|
| NOTE | This equipment is tested with stand-alone condition or with the combination with the accessories supplied by Agilent Technologies against the requirement of the standards described in the Declaration of Conformity. If it is used as a system component, compliance of related regulations and safety requirements are to be confirmed by the builder of the system. |
|-------------|---|
-
- **Ground the Instrument**

To avoid electric shock, the instrument chassis and cabinet must be grounded with the supplied power cable's grounding prong.
 - **DO NOT Operate in an Explosive Atmosphere**

Do not operate the instrument in the presence of inflammable gasses or fumes. Operation of any electrical instrument in such an environment clearly constitutes a safety hazard.
 - **Keep Away from Live Circuits**

Operators must not remove instrument covers. Component replacement and internal adjustments must be made by qualified maintenance personnel. Do not replace components with the power cable connected. Under certain conditions, dangerous voltage levels may remain even after the power cable has been disconnected. To avoid injuries, always disconnect the power and discharge circuits before touching them.
 - **DO NOT Service or Adjust the Instrument Alone**

Do not attempt internal service or adjustment unless another person, capable of rendering first aid and resuscitation, is present.
 - **DO NOT Substitute Parts or Modify the Instrument**

To avoid the danger of introducing additional hazards, do not install substitute parts or perform unauthorized modifications to the instrument. Return the instrument to an Agilent Technologies Sales and Service Office for service and repair to ensure that

safety features are maintained in operational condition.

- Dangerous Procedure Warnings

Warnings, such as the example below, precede potentially dangerous procedures throughout this manual. Instructions contained in the warnings must be followed.

WARNING

Dangerous voltage levels, capable of causing death, are present in this instrument. Use extreme caution when handling, testing, and adjusting this instrument.

- Do not connect the measuring terminals to mains.

Safety Symbol

General definitions of safety symbols used on the instrument or in manuals are listed below.



Instruction Manual symbol: the product is marked with this symbol when it is necessary for the user to refer to the instrument manual.



Alternating current.



Direct current.



On (Supply).



Off (Supply).



In position of push-button switch.



Out position of push-button switch.



Frame (or chassis) terminal. A connection to the frame (chassis) of the equipment which normally include all exposed metal structure.

WARNING

This warning sign denotes a hazard. It calls attention to a procedure, practice, condition or the like, which, if not correctly performed or adhered to, could result in injury or death to personnel.

CAUTION

This Caution sign denotes a hazard. It calls attention to a procedure, practice, condition or the like, which, if not correctly performed or adhered to, could result in damage to or destruction of part or all of the product.

NOTE

Note denotes important information. It calls attention to a procedure, practice, condition or the like, which is essential to highlight.

Certification

Agilent Technologies certifies that this product met its published specifications at the time of shipment from the factory. Agilent Technologies further certifies that its calibration measurements are traceable to the United States National Institute of Standards and Technology, to the extent allowed by the Institution's calibration facility, or to the calibration facilities of other International Standards Organization members.

Documentation Warranty

The material contained in this document is provided "as is," and is subject to being changed, without notice, in future editions. Further, to the maximum extent permitted by applicable law, Agilent disclaims all warranties, either express or implied with regard to this manual and any information contained herein, including but not limited to the implied warranties of merchantability and fitness for a particular purpose. Agilent shall not be liable for errors or for incidental or consequential damages in connection with the furnishing, use, or performance of this document or any information contained herein. Should Agilent and the user have a separate written agreement with warranty terms covering the material in this document that conflict with these terms, the warranty terms in the separate agreement will control.

Exclusive Remedies

The remedies provided herein are buyer's sole and exclusive remedies. Agilent Technologies shall not be liable for any direct, indirect, special, incidental, or consequential damages, whether based on contract, tort, or any other legal theory.

Assistance

Product maintenance agreements and other customer assistance agreements are available for Agilent Technologies products.

For any assistance, contact your nearest Agilent Technologies Sales and Service Office. Addresses are provided at the back of this manual.

Typeface Conventions

Bold	Boldface type is used when a term is defined. For example: icons are symbols.
<i>Italic</i>	Italic type is used for emphasis and for titles of manuals and other publications.
[Hardkey]	Indicates a hardkey labeled “Hardkey.”
Softkey	Indicates a softkey labeled “Softkey.”
[Hardkey] - Softkey1 - Softkey2	Indicates keystrokes [Hardkey] - Softkey1 - Softkey2 .

4287A Documentation Map

The following manuals are available for the 4287A.

- **Operation Manual (P/N: 04287-900x4)**
Most of basic information necessary for using 4287A is described in this manual. It includes the way of installation, preparation, measurement operation including calibration, performances (specifications), key definitions, and error messages.
- **Programming Manual (P/N: 04287-900x1)**
The Programming Manual shows how to write and use program to control the 4287A.
- **Service Manual (P/N: 04287-901x0)**
This manual describes how to adjust and repair the 4287A, and how to carry out performance tests.

Software Installed

The Windows operating system installed in this machine is customized for more effective operation, and has different functions that are not part of the Windows operating system for ordinary PCs (personal computers). Therefore, do not attempt to use the system in ways other than those described in this manual or to install Windows-based software (including anti-virus software) for ordinary PCs as doing so may cause malfunctions.

Also note the followings.

- Do not update the Windows operating system installed in this machine to the Windows operating system for ordinary PCs. Doing so will cause malfunctions.
- Do not allow any computer virus to infect the system. This machine has no virus check function nor anti-virus software installed.

Agilent Technologies will not be held liable for any failure or damage arising from negligence regarding these prohibitions and warnings.

NOTE

If the pre-installed software is damaged somehow, resulting in errant behavior by the machine, perform a "system recovery".

1. General Information

Organization of Service Manual	16
Instrument Covered by This Manual	18
Required Equipment	19

2. Maintenance

Test Equipment	22
How to Set the 4287A for Maintenance	23
Indication of measurement point setup display	23
How to add measurement point	24
How to change frequency	26
How to change averaging factor	27
How to change oscillator level	28
Selection between single point measurement or list measurement	29
Selection of measurement point	30
Selection of measurement parameters in single point measurement display	31
Performance Test	32
Introduction	32
Frequency Accuracy Test	33
Power Level Accuracy Test	36
Impedance Measurement Accuracy Test	40
Function Test	48
Introduction	48
Warm Up Time	48
Ambient Conditions	48
DC Resistance Measurement Accuracy Test	49
Low Loss Capacitor Check	51
Calculating Sheet	52
Performance Test	52
Function Test	64
Test Record	65
Performance Test Record	65
Function Test Record	74

3. Adjustment

Safety Considerations	76
Warm-up for Adjustment	76
Preparation for using the Adjustment Program	77
Required Controller	77
Installing Agilent VEE for Personal Computer	77
Installing Adjustment Program into Your PC	77
Equipment Setup	78
Order of Adjustment	79
Running the Adjustment Program	81
Procedure	81
A1 VCXO Frequency Adjustment	84
Required Equipment	84
Procedure	84

A3 Local Level Adjustment	85
Required Equipment	85
Procedure	85
A3 Output AGC Gain Adjustment	86
Required Equipment	86
Procedure	86
A3 Output Level Adjustment	87
Required Equipment	87
Procedure	87
A4 AGC Gain Adjustment	89
Required Equipment	89
Procedure	89
A4 Local Level Adjustment	90
Required Equipment	90
Procedure	90
A4 IF Gain Adjustment	91
Required Equipment	91
Procedure	91
A4 RF Gain Adjustment	92
Required Equipment	92
Procedure	92
A4 DC Gain Adjustment	93
Required Equipment	93
Procedure	93
4. Troubleshooting	
Introduction	96
Service Mode and Instrument Mode	97
Procedure to Change from Instrument Mode to Service Mode	97
Procedure to Change from Service Mode to Instrument Mode	98
To Troubleshoot the Instrument	99
Primary Trouble Isolation	99
No Display Troubleshooting	101
Booting Process Troubleshooting (for serial prefix JP1KG, JP2KG, and MY432)	105
Booting Process Troubleshooting (for serial prefix MY433 and later)	113
Troubleshooting Using Internal Test	117
Power On Self Test	117
PLL unlock	117
To Execute Internal Test	117
Contents of the Internal Test	118
Function Depend Troubleshooting	119
Functions	119
To check the Front Panel	123
To check the LCD and Back Light	123
To check the External Keyboard	124
To check the Mouse	124
To check the FDD	124
To check the VGA Display Output	125
To check the External Trigger Input	125

To check the LAN (for serial prefix JP1KG, JP2KG, and MY432)	125
To Check the LAN (for serial prefix MY433 and later)	127
To check the Handler Interface	130
To check the GPIB	131
To check the Printer Parallel port (for serial prefix JP1KG, JP2KG, and MY432)	131
Analog Section Troubleshooting	132
Performance Tests Failure Troubleshooting	132
Fails in specific setting	133
Troubleshooting by Each Assembly	134
To Configure the A20 Digital Motherboard and BIOS (for serial prefix JP1KG, JP2KG, and MY432) . .	136
To Identify the Motherboard Used	136
Configure the Motherboard.	137
To Confirm or Set the BIOS Options	139
To Configure the A20 Digital Motherboard and BIOS (for serial prefix MY433 and later)	149
To Identify the Motherboard Installed	149
Configure the Motherboard.	149
Testing DRAM on the Motherboard	149
To Confirm or Set the BIOS Options	151
5. Theory of Operation	
Overall Instrument Operation	160
Digital Section	163
A20 Digital Motherboard (for serial prefix JP1KG, JP2KG, and MY432)	163
A20 Digital Motherboard (for serial prefix MY433 and later)	163
A21 Analog Interface Board	163
A22 Front Panel Keyboard	163
A23 Handler Interface Board	163
A24 GPIB Board	163
A25 LAN Interface Board (for serial prefix JP1KG, JP2KG, and MY432)	163
A26 Display Board	164
A27 Mass Storage Disk Drive.	164
A28 FDD (Floppy Disk Drive)	164
A51 LCD (Liquid Crystal Display)	164
A52 Inverter Board	164
Analog Section	165
A1 Reference Oscillator Board	167
A3 Source Board	167
A4 Receiver Board	168
A6 Test Head Board	169
A10 Analog Motherboard	169
6. Replaceable Parts	
Ordering Information	172
Direct Mail Order System	172
Exchange Assemblies	173
Replaceable Parts List (for serial prefix JP1KG, JP2KG, and MY432)	174
Power Cables and Plug Configurations.	174
Top View (Measure Assembly).	174

Top View (Cables & Other Parts)	176
Top View (Miscellaneous Parts)	178
Top View (Under Power Supply)	180
Front View (Analog Boards and Semi Rigid Cables)	182
Front Panel	184
Front Panel (Back Side)	186
Rear View	187
Side View	188
Test Head	190
Mass Storage Disk Drive Assembly	191
Power Supply Assembly	192
Other Parts	192
Replaceable Parts List (for serial prefix MY433 and later)	194
Power Cables and Plug Configurations	194
Top View (Measure Assembly)	194
Top View (Cables & Other Parts)	196
Top View (Miscellaneous Parts)	198
Top View (Under Power Supply)	200
Front View (Analog Boards and Semi Rigid Cables)	202
Front Panel	204
Front Panel (Back Side)	206
Rear View	207
Side View	208
Test Head	210
Floppy Disk Drive Assembly	211
Mass Storage Disk Drive Assembly	212
Power Supply Assembly	213
Other Parts	214
7. Replacement Procedure	
Replacing an Assembly	216
Outer Cover Removal	217
Tools Required	217
Procedure	217
Front Panel Removal	218
Tools Required	218
Procedure	218
A50 Power Supply Assembly Removal (for serial prefix JP1KG, JP2KG, and MY432)	219
Tools Required	219
Procedure	219
A50 Power Supply Assembly Removal (for serial prefix MY433 and later)	220
Tools Required	220
Procedure	220
A27 Mass Storage Disk Drive Assembly Removal	221
Tools Required	221
Procedure	221
A28 FDD (Floppy Disk Drive) Removal	222
Tools Required	222
Procedure	222

A20 Digital Motherboard Removal (for serial prefix JP1KG, JP2KG, and MY432)	223
Tools Required	223
Procedure.	223
A20 Digital Motherboard Removal (for serial prefix MY433 and later)	224
Tools Required	224
Procedure.	224
CPU Replacement (for serial prefix JP1KG, JP2KG, and MY432)	225
Tools Required	225
Replacement Procedure.	225
DIMM64MB Memory Module Removal (for serial prefix JP1KG, JP2KG, and MY432)	227
Procedure.	227
A1/A3/A4 Board Removal	227
Tools Required	227
Procedure.	227
A26 Display/A24 GPIB/A25 LAN/A23 Handler Interface Board Removal (for serial prefix JP1KG, JP2KG, and MY432)	228
Tools Required	228
Procedure.	228
A24 GPIB Card Replacement (for serial prefix MY433 and later)	229
Tools Required	229
Removal Procedure	229
Replacement Procedure.	230
A26 Display Board Removal (for serial prefix MY433 and later)	231
Tools Required	231
Procedure.	231
A51 LCD Removal	232
Tools Required	232
Procedure.	232
A21 Analog Interface Board Replacement.	233
Tools Required	233
Removal Procedure	233
A23 Handler Interface Board Removal	234
Tools Required	234
Procedure.	234
8. Post-Repair Procedures	
Post-Repair Procedures.	236
A. Manual Changes	
Manual Changes	240
B. System Installation for A27 Mass Storage	
System Installation for A27 Mass Storage (for serial number JP1KG and A27 that has never been replaced)	
242	
Required Parts	242
System Installation Procedure.	242
System Recovery (for serial number JP2KG, MY432 or JP1KG with its A24 has been replaced by 04287-61031/-61032)	
256	

Notes on executing system recovery	256
Procedure to execute system recovery	257
System Recovery (for serial prefix MY433 and later)	259
Types of system recoveries	259
Notes on executing system recovery	259
Procedure to execute system recovery	260
Procedure to create the user backup image	263
Procedure to execute the user recovery function	266
Initial Registration of 4287A (for serial prefix MY433 and later)	269
C. Firmware Installation	
Firmware Installation	274
Required Parts	274
How to install the 4287A firmware	274
D. Back-up User Files in A27 Mass Storage	
Back-up Files	280
Required Parts	280
How to Back-up the 4287A Files	280
E. Power Requirement	
Preparation for Power Supply	282
Power Requirements	282
Power Cable	282
Turning the Power ON and OFF	284
Turning the power ON	284
Turning the power OFF	284
F. Error Messages	
Order of error number	286

1 General Information

The Service Manual is a guide to servicing the 4287A RF LCR Meter. The manual contains information requisite to do performance test, adjust, troubleshoot, and repair.

Organization of Service Manual

Tabs are used to divide the major chapter and appendix of this manual. The contents of each chapter and appendix in this manual are as follows;

Chapter 1, “General Information,”

The Service Manual is a guide to servicing the 4287A RF LCR Meter. The manual contains information requisite to do performance test, adjust, troubleshoot, and repair.

Chapter 2, “Maintenance,”

This chapter provides information on how to verify the 4287A performance. The maintenance consists of performance test and function test.

Chapter 3, “Adjustment,”

This chapter provides the adjustment procedure for the 4287A RF LCR Meter to ensure that the 4287A is within its specifications.

Chapter 4, “Troubleshooting,”

This chapter provides procedure to isolate the failure assembly in the 4287A RF LCR Meter.

Chapter 5, “Theory of Operation,”

This chapter provides the theory of operation of the 4287A RF LCR Meter.

Chapter 6, “Replaceable Parts,”

This chapter contains information for ordering replacement parts for the 4287A RF LCR Meter.

Chapter 7, “Replacement Procedure,”

This chapter provides procedure for removing and replacing the major assemblies in the 4287A RF LCR Meter.

Chapter 8, “Post-Repair Procedures,”

This chapter lists the procedures required to adjust and verify the 4287A operation after an assembly is replaced with a new one.

Appendix A, “Manual Changes,”

This appendix contains the information required to adapt this manual to versions or configurations of the 4287A manufactured earlier than the current printing date of this manual. The information in this manual applies directly to 4287A units with the serial number that is printed on the title page of this manual.

Appendix B, “System Installation for A27 Mass Storage,”

This appendix describes how to install the operation system to the A27 mass storage. When the operating system in the A27 mass storage has damage, you can recovery it before replacing the A27 by this procedure.

Appendix C, “Firmware Installation,”

This appendix describes how to install the 4287A firmware. When you want to install or update the 4287A firmware, refer to this appendix.

Appendix D, “Back-up User Files in A27 Mass Storage,”

This appendix describes how to back-up the user files which is saved in the A27 mass storage. Back-up the user files before the replacement or the system installation, if possible.

Appendix E, “Power Requirement,”

The Service Manual is a guide to servicing the 4287A RF LCR Meter. The manual contains information requisite to do performance test, adjust, troubleshoot, and repair.

Appendix F, “Error Messages,”

The Agilent 4287A provides error messages to indicate its operating status. This appendix describes the error messages of the 4287A in order of error number. To search error messages alphabetically, refer to the Operation Manual.

Instrument Covered by This Manual

Agilent Technologies uses a two-part, ten-character serial number label (See Figure 1-1) attached to the instrument's rear panel. The first five characters are the serial prefix and the last five digits are the suffix.

Figure 1-1

Serial Number Label



An instrument manufactured after the printing date of this manual may have serial number prefix that is not listed on the title page. This unlisted serial number prefix indicates the instrument is different from those described in this manual. The manual for this new instrument may be accompanied by a yellow Manual Changes supplement or have a different manual part number. This sheet contains “change information” that explains how to adapt the manual to the newer instrument.

In addition to change information, the supplement may contain information for correcting errors (Errata) in the manual. To keep this manual as current and accurate as possible, Agilent Technologies recommends that you periodically request the latest Manual Changes supplement. The supplement for this manual is identified by this manual's printing data and is available from Agilent Technologies. If the serial prefix or number of an instrument is lower than that on the title page of this manual, see Appendix A, Manual Changes. For information concerning a serial number prefix that is not listed on the title page or in the Manual change supplement, contact the nearest Agilent Technologies office.

Required Equipment

Table 1-1 lists the recommended equipment for performing maintenance on the 4287A.

Table 1-1 Recommended Test Equipment

Equipment	Critical specifications	Recommended Model	Qty.	Use ^{*1}
Frequency Counter	Frequency: 120 Hz to 3 GHz Accuracy: < 2.5 ppm	5343A, 53131/2A Opt.010 & 030 ^{*2} , or 53181A Opt.010 & 030 ^{*2}	1	P,A
Multimeter	No substitute	3458A	1	P
Power Meter	No Substitute	438A ^{*3} , E4418A/B, or E4419A/B	1	P,A
Power Sensor	Frequency Range: 1 MHz to 3 GHz Power: -35 dBm to 1 dBm	8482A+8481D ^{*4} , E4412A ^{*5} , or E9304A ^{*6}	1	P,A
Network Analyzer	Frequency: 5 GHz to 6 GHz	8753ES	1	F
Performance Test Kit	No Substitute	16190B	1	P,F
Calibration Kit	No Substitute	16195B ^{*7}	1	P,F,A
Spectrum Analyzer	Frequency: 10 kHz to 5 GHz	8563E	1	T
Oscilloscope		54810A	1	T
Test Fixture Station	No Substitute	p/n 04287-60121	1	P,F,A
Cable	BNC(m)-BNC(m) Cable, 61 cm	p/n 8120-1839	1	P,A
Adapter	7mm-3.5mm(m) Adapter	p/n 1250-1746	1	P,F,A
	N(m)-BNC(f) Adapter	p/n 1250-0780	1	P,A
	7mm-N(f) Adapter	11524A	1	P,A
	Dual Banana - BNC Adapter	1251-2277	1	A
	Coaxial Termination Feed Thru	11048C	1	A
Torque Wrench	Size: 3/4 inch Torque: 136 N-cm	p/n 8710-1766	1	P

*1.P: Performance Tests, F: Function Tests, A: Adjustment, T: Troubleshooting

*2.Opt.050 and Opt.124 can be substituted for Opt.030. In this case, a N(m)-BNC(f) adapter is necessary.

*3.438A cannot be used with E4412A or E9304A.

*4.8481D is not necessary for Adjustment.

*5.E4412A is not necessary for Adjustment.

*6.If E9304A is used, the multimeter is not necessary.

*7. 16195B is a furnished accessory for the 4287A. But, it is not furnished, if the 4287A has an Option 001.

General Information
Required Equipment

2 Maintenance

This chapter provides information on how to verify the 4287A performance. The maintenance consists of performance test and function test.

Test Equipment

The required test equipment is listed on Table 1-1 on page 19. Use only calibrated equipment when doing the performance test or the function test for the 4287A.

How to Set the 4287A for Maintenance

This section provides procedure to set the 4287A in the performance test and function test.

Indication of measurement point setup display

You can get the measurement point setup display according to the following steps:

- Step 1.** Press the **[Setup View]** key until the measurement point setup display (Figure 2-1) appears.

Figure 2-1

Measurement point setup display

No.	Frequency	Average	Power	dBm
1	1.0000 MHz	1	-13.0	dBm
2				
3				
4				
5				
6				
7				
8				
9				
10				
11				
12				
13				
14				
15				
16				
17				
18				
19				

4287aoj090

How to add measurement point

The measurement point number 1 of each table (1 to 8) has data consisting of a frequency of 1 MHz, averaging factor of 1, and oscillator level of 0 dBm as a preset state.

Add new measurement points to the measurement points already entered in the specified table, as follows:

- Step 1.** Use the mouse or  keys to select a cell one level below the already entered frequency cell. (This is called an active cell; it is enclosed in a bold-face box selected for data entry. See Figure 2-2.)

Figure 2-2

State where frequency cell for new measurement point to be added is selected

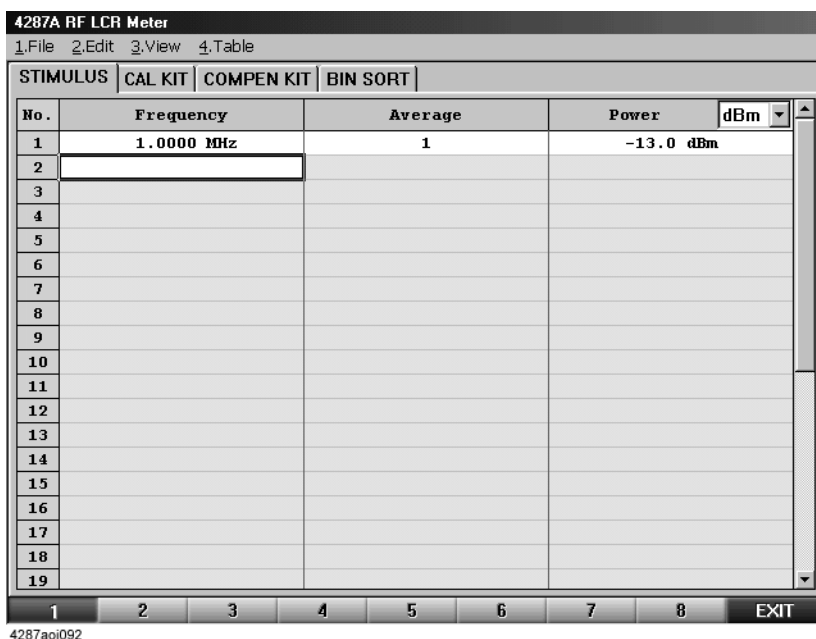

No.	Frequency	Average	Power
1	1.0000 MHz	1	-13.0 dBm
2			
3			
4			
5			
6			
7			
8			
9			
10			
11			
12			
13			
14			
15			
16			
17			
18			
19			

NOTE In this case, selectable cells are displayed brighter than other cells.

- Step 2.** Press the numeric entry keys ([0] to [9] and [.] and a unit key ([G/n], [M/μ], [k/m] or [×1]) in the entry block continuously to enter the frequency of the measurement point to be added.

To enter 2 MHz, for example, press [2] (Figure 2-3) and [M/μ] without interruption.

Figure 2-3 Addition of measurement frequency

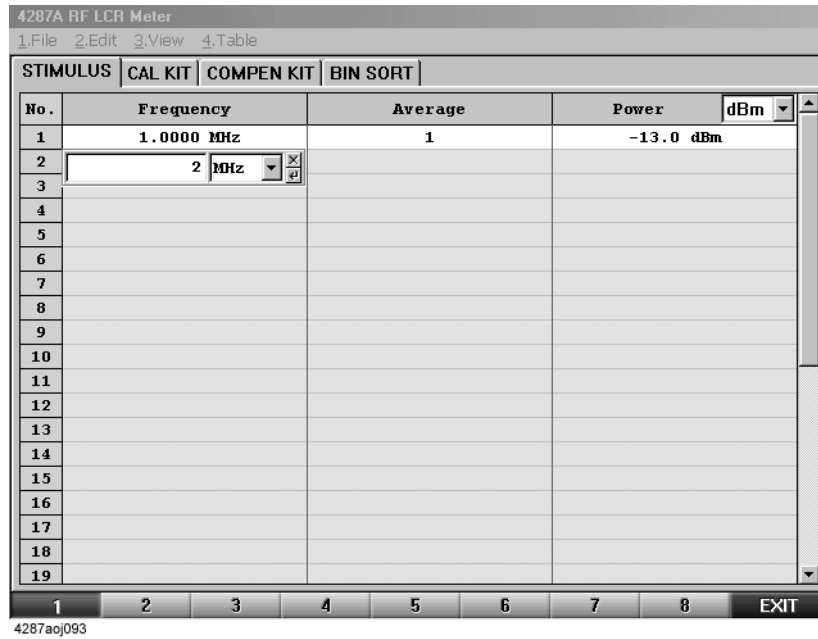

NOTE If you add frequency as a new measurement point, the same settings of the averaging factor and oscillator level as those of the previous measurement point are automatically input.

Step 3. Repeat Steps 1 and 2 to add the required measurement point (Figure 2-4).

Figure 2-4 Example of setting measurement points at intervals of 1 MHz, from 1 MHz to 10 MHz

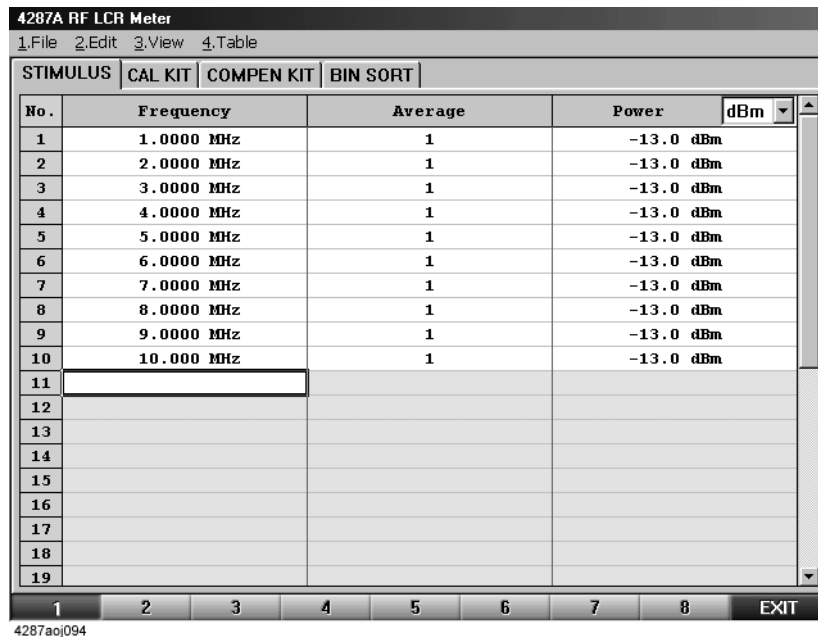

How to change frequency

Change the frequency of the already set measurement point as follows:

- Step 1.** Use the mouse or  keys to select the frequency cell at the measurement point you want to change.
- Step 2.** Enter a new frequency by pressing the numeric entry keys of the entry block ([0] to [9] and [.] and a unit key ([G/n], [M/μ], [k/m], or [×1]) without interruption.
- To enter 5.5 MHz, for example, press [5], [.] and [5] (Figure 2-5), then [M/μ] without interruption.

Figure 2-5

How to change frequency

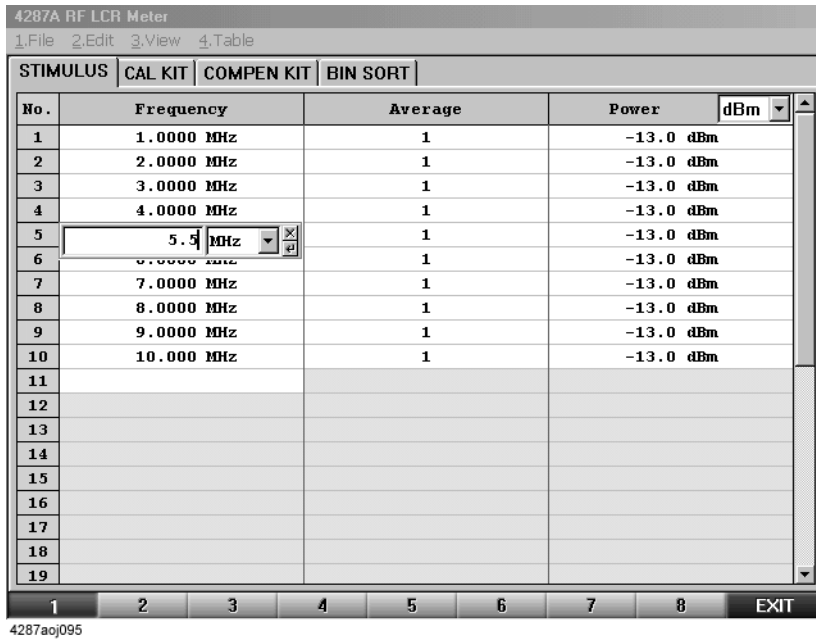

How to change averaging factor

Change the averaging factor of the already set measurement point as follows:

- Step 1.** Use the mouse or  keys to select the averaging factor cell at the measurement point you want to change.
- Step 2.** Enter a new averaging factor by pressing the numeric entry keys of the entry block ([0] to [9]) and [×1]) without interruption.

To set the averaging factor to “10”, for example, press [1] and [0] (Figure 2-6), then [×1].

Figure 2-6

How to change the averaging factor

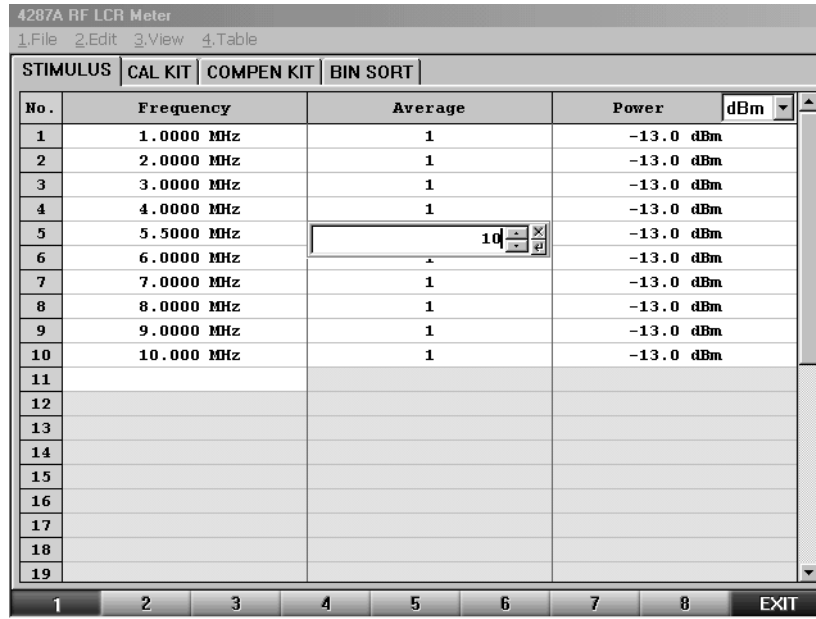

No.	Frequency	Average	Power	dBm
1	1.0000 MHz	1	-13.0	dBm
2	2.0000 MHz	1	-13.0	dBm
3	3.0000 MHz	1	-13.0	dBm
4	4.0000 MHz	1	-13.0	dBm
5	5.5000 MHz	10	-13.0	dBm
6	6.0000 MHz	1	-13.0	dBm
7	7.0000 MHz	1	-13.0	dBm
8	8.0000 MHz	1	-13.0	dBm
9	9.0000 MHz	1	-13.0	dBm
10	10.000 MHz	1	-13.0	dBm
11				
12				
13				
14				
15				
16				
17				
18				
19				

4287a0j096

2. Maintenance

How to change oscillator level

Change the oscillator level of the already set measurement point as follows:





- Step 1.** Use the mouse or     keys to select the oscillator level cell at the measurement point you want to change.
- Step 2.** Enter a new oscillator level by pressing the numeric entry keys of the entry block ([0] to [9], [-] and [.] and [×1] without interruption.
- To set the oscillator level to -10 dBm, for example, press [-], [1] and [0] (Figure 2-7), then [×1].

Figure 2-7

How to change oscillator level

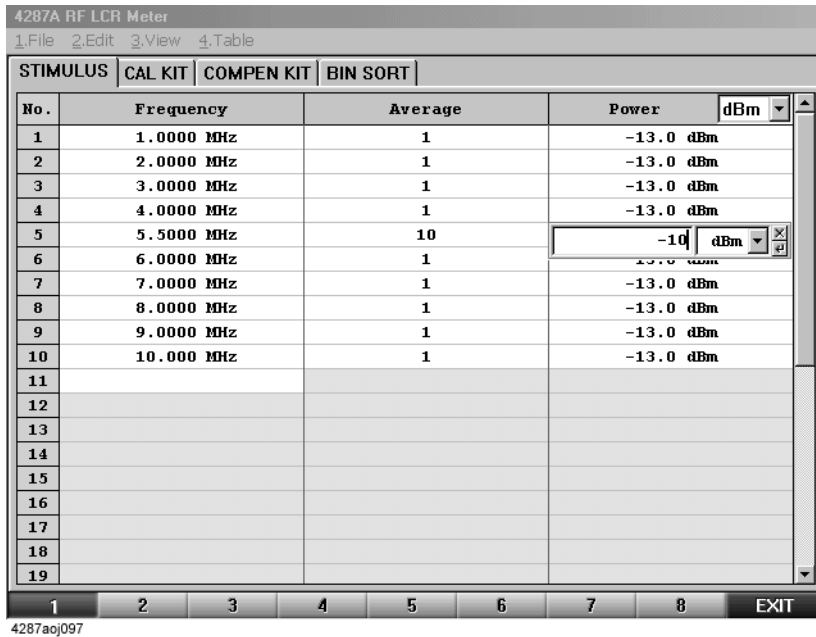

4287A RF LCR Meter
 1.File 2.Edit 3.View 4.Table

STIMULUS	CAL KIT	COMPEN KIT	BIN SORT	
No.	Frequency	Average	Power	dBm
1	1.0000 MHz	1	-13.0	dBm
2	2.0000 MHz	1	-13.0	dBm
3	3.0000 MHz	1	-13.0	dBm
4	4.0000 MHz	1	-13.0	dBm
5	5.5000 MHz	10	-10	dBm
6	6.0000 MHz	1	-13.0	dBm
7	7.0000 MHz	1	-13.0	dBm
8	8.0000 MHz	1	-13.0	dBm
9	9.0000 MHz	1	-13.0	dBm
10	10.000 MHz	1	-13.0	dBm
11				
12				
13				
14				
15				
16				
17				
18				
19				

1 2 3 4 5 6 7 8 EXIT
 4287aaj097

Selection between single point measurement or list measurement

When setup display appears, press **[Meas View]**, and single point measurement display (Figure 2-8) or list measurement display (Figure 2-9) will appear. After that, the single point measurement display and list measurement display will appear alternately when the **[Meas View]** key is pressed.

Figure 2-8

Single point measurement display

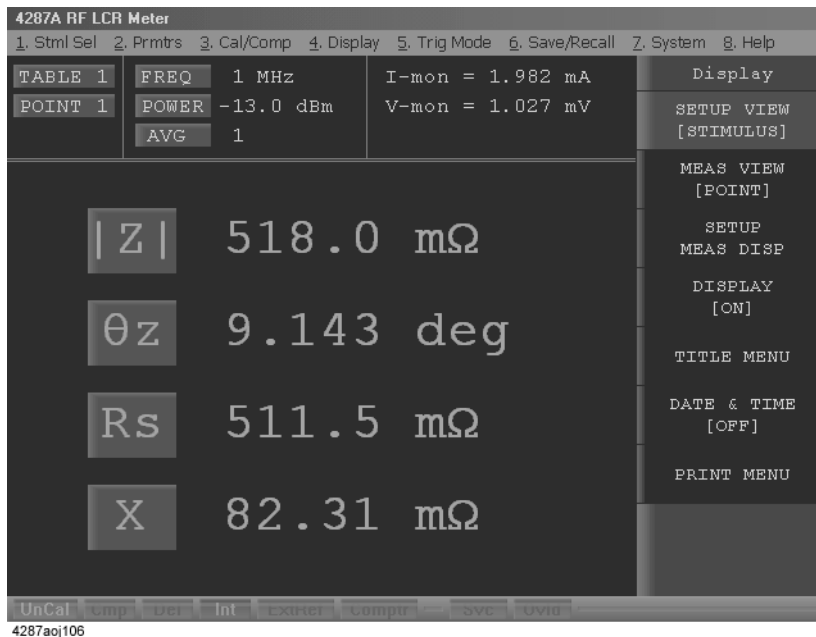
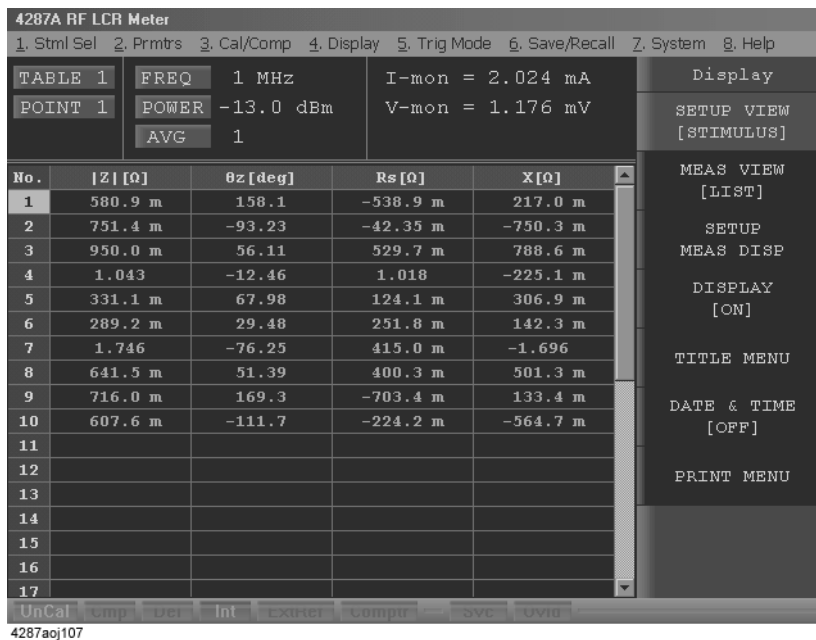

Figure 2-9

List measurement display



2. Maintenance

Selection of measurement point

Select the measurement point in the single point measurement display as follows:

- Step 1.** Press the **[Stim Select]** key of the measurement block to display the measurement point selection softkey menu.
- Step 2.** Select the **POINT No. []** key from the softkey menu, and the measurement point number selection softkey menu will appear.
- Step 3.** Select the measurement point number from the softkey menu.

Selection of measurement parameters in single point measurement display

The single point measurement display allows simultaneous indication of a maximum of four parameters to be provided for a selected single point. Set the measurement parameters according to the following steps:

- Step 1.** Press the **[Prmtr]** key of the measurement block to display the parameter setup softkey menu.
- Step 2.** Select the **SETUP MEAS PRMTRS** key from the softkey menu, and the measurement parameter setup softkey menu will appear.
- Step 3.** Select the desired measurement parameter from four measurement parameters (**PRMTR-1 []** to **PRMTR-4 []**) appearing in the softkey menu, and the measurement parameter selection softkey menu for the measurement parameter number will appear.
- Step 4.** Select the desired measurement parameter from the softkey menu.

Softkey label	Measurement parameter
 Z 	Absolute value of impedance
 Y 	Absolute value of admittance
Ls	Equivalent series inductance
Lp	Equivalent parallel inductance
Cs	Equivalent series capacitance
Cp	Equivalent parallel capacitance
R	Equivalent series resistance
Rs	Equivalent series resistance
Rp	Equivalent parallel resistance
Q	Quality factor ^{*1}
D	Dissipation factor ^{*2}
X	Equivalent series reactance
G	Equivalent parallel conductance
B	Equivalent parallel susceptance
θz(rad)	Impedance phase (radian)
θz(deg)	Impedance phase (deg.)
θy(rad)	Admittance phase (radian)
θy(deg)	Admittance phase (deg.)

*1. Quality factor

*2. Dissipation factor

Performance Test

Introduction

This section provides the test procedures used to verify that the 4287A is able to make a measurement as specified by Agilent Technologies. The performance tests can also be used for incoming inspection, and for verification after troubleshooting or adjustment. If the performance tests indicate that the 4287A is *NOT* operating within the specified limits, check your test setup, then proceed with troubleshooting if necessary.

Warm Up Time

Allow the 4287A to warm up for at least 30 minutes before you execute any of the performance tests

Ambient Conditions

Perform all performance tests in ambient conditions of $23\text{ }^{\circ}\text{C} \pm 5\text{ }^{\circ}\text{C}$, $\leq 70\%$ RH.

Performance Test Interval

The performance test should be performed periodically. The recommended test interval is 12 months.

NOTE

The test interval depends on maintenance of use and the environmental conditions under which the instrument is used. You may find that the test interval could be shortened or lengthened; however, such a decision should be based on substantial quantitative data.

Performance Test Record and Calculation Sheet

Performance test record lists all test points, acceptable test limits, test result entry columns, and measurement uncertainties. The listed measurement uncertainties are valid only when the recommended test equipment is used.

The calculation sheet is used as an aid for recording raw measurement data, and for calculating the performance test results.

The procedure for using the calculation sheet and performance test record is;

1. Photo copy the calculation sheet.
2. Follow the performance test procedure and record the measurement values, the 4287A's reading, etc., into the specified column on the calculation sheet.
3. Calculate the test result using the appropriate equation given on the calculation sheet, and record the test result into the Test Result column of the performance test record.

Frequency Accuracy Test

This test verifies the 4287A's test signal frequency accuracy with a frequency counter.

Specification

Frequency Accuracy: ± 10 ppm

Required Equipment

Description	Recommended Model
Frequency Counter	53131/2A Opt.010 and 030 ^{*1} , 53181A Opt.010 and 030 ^{*1} , or 5343A
Test Fixture Station	p/n 04287-60121
BNC(m)-BNC(m) Cable, 61 cm	p/n 8120-1839
7mm-3.5mm(m) Adapter	p/n 1250-1746
N(m)-BNC(f) Adapter	p/n 1250-0780
7mm-N(f) Adapter	11524A

*1. Opt.050 and Opt.124 can be substituted for Opt.030. In this case, a N(m)-BNC(f) adapter is necessary.

Procedure

NOTE

In the following procedure, the 53181A is used. Perform the same operation if another frequency counter is used.

1. Connect the equipment as shown in Figure 2-10.

Figure 2-10 Frequency Accuracy Test Setup 1

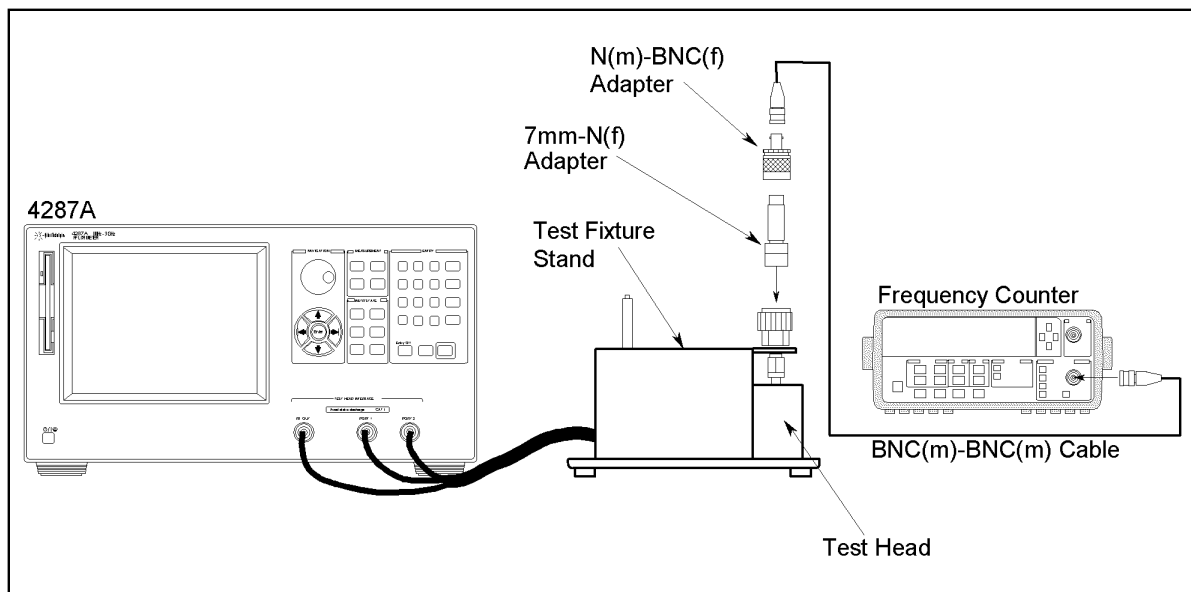

4287ase02005

2. Press **[Preset]** to preset the 4287A.
3. Set the 4287A as follows referring to “How to Set the 4287A for Maintenance” on page 23.

Frequency	Average	Power
1 MHz	1	0 dBm

4. Press **[Stop/Single]** on the 53181A front panel to make a single measurement.
5. Subtract the analyzer setting(1 MHz) from the frequency counter reading, and record the result on the performance test record.
6. Disconnect the BNC connector from A ch in the 53181A front panel, then connect it to the B ch.

Figure 2-11 Frequency Accuracy Test Setup 2

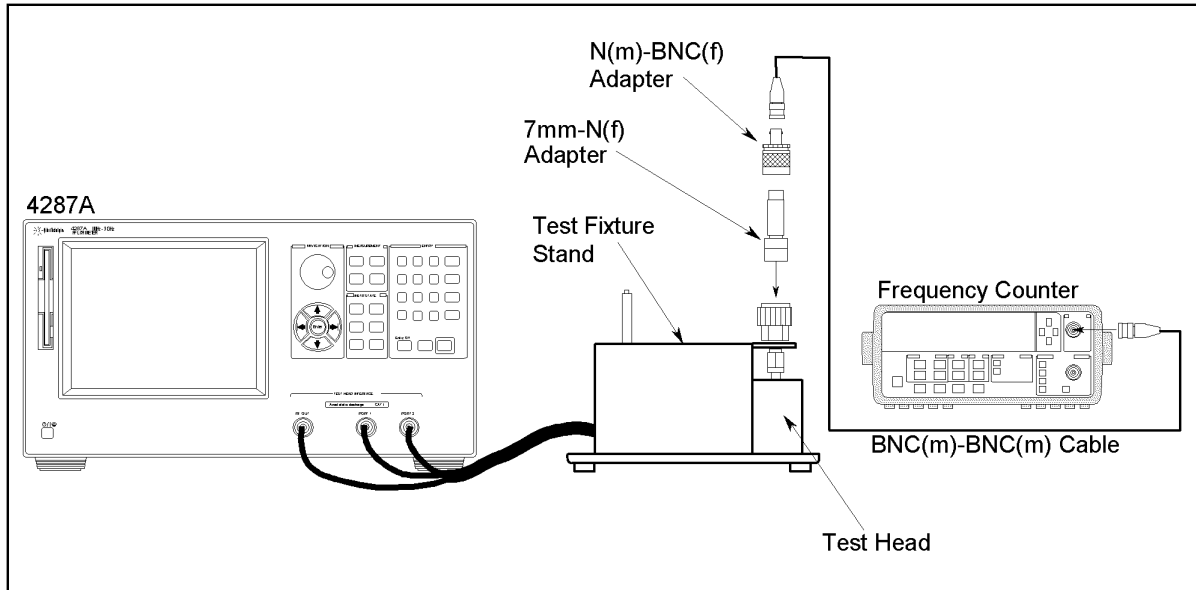

4287ase02004

7. Set the 4287A's frequency to 3GHz.
8. Press **[Stop/Single]** on the 53181A front panel to make a single measurement.
9. Subtract the analyzer setting(3 GHz) from the frequency counter reading, and record the result on the performance test record.

Power Level Accuracy Test

This test verifies the 4287A's test signal power level accuracy with a power meter and a multimeter.

Specification

Power Level Accuracy(without Opt.020) ± 2 dB @ ≤ 1 GHz

± 3 dB @ > 1 GHz

Power Level Accuracy(with Opt.020) ± 3 dB @ ≤ 1 GHz

± 4 dB @ > 1 GHz

Required Equipment

Description	Recommended Model
Power Meter	E4418A/B or E4419A/B
Power Sensor	E4412A
Multimeter	3458A
Coaxial Termination Feed Thru	11048C
Test Fixture Station	p/n 04287-60121
BNC(m)-BNC(m) Cable, 61 cm	p/n 8120-1839
7mm-3.5mm(f) Adapter	p/n 1250-1746
N(m)-BNC(f) Adapter	p/n 1250-0780
7mm-N(f) Adapter	11524A
Dual Banana - BNC Adapter	1251-2277

Procedure

1. Connect the equipment as shown in Figure 2-12.

Figure 2-12 Power Level Accuracy Test Setup

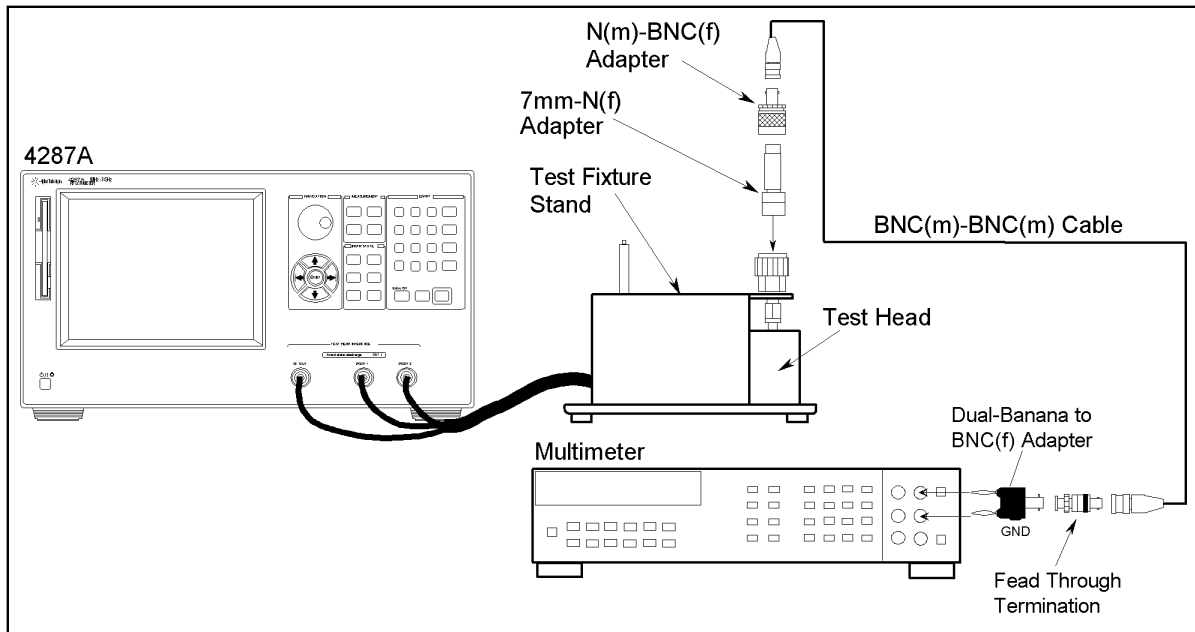

4287ase02012

2. Press **[Preset]** to preset the 4287A.
3. Set the 4287A as follows “How to Set the 4287A for Maintenance” on page 23.

Frequency	Average	Power
1 MHz	1	-15 dBm

4. Press **[Meas Setup]** to show single point measurement display.
5. Press **[Trigger Mode]**.
6. Select TRIG SOURCE using key, then press key.
7. Select MANUAL using key, then press key.
8. Press **[Trigger]** to make a measurement.
9. Press **Reset** key (blue,?) to initialize the 3458A, then Set it as follows.
 - a. Press **[ACV]** to set the measurement mode to AC voltage.
 - b. Press **S**(blue - **[N Rdgs/Trig]**), , , to display SETACV.
 - c. Press , , to display SYNC, then press **[Enter]**
 - d. Press **[NPLC]** - **[1]** - **[0]** - **[0]** - **[Enter]**
10. Record the multimeter reading to the calculation sheet.
11. Calculate the test result according to the calculation sheet, then record it to the performance test record.

NOTE

If the cable length is 1 m, record the result to “Power Level Accuracy Test (without Opt. 020)”. If it is 2 m, record it to “Power Level Accuracy Test (with Opt. 020)”

Maintenance
Performance Test

12. Perform zeroing and calibrating the power meter
13. Connect the equipment as shown in Figure 2-13.

Figure 2-13 Power level Accuracy Test Setup

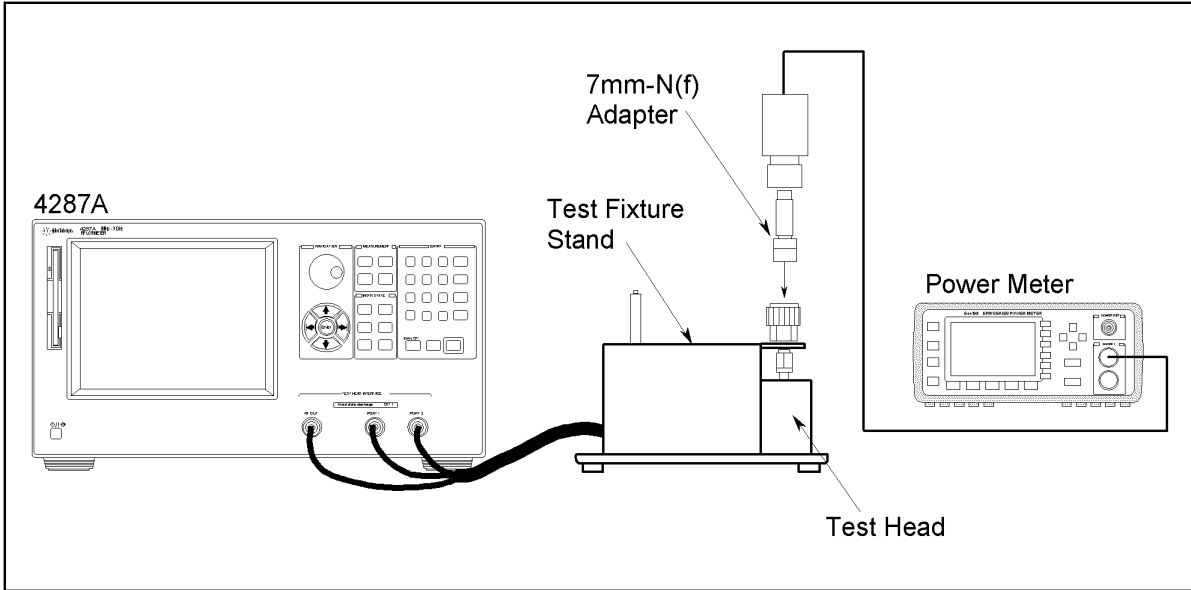

4287ase02002

14. Set the measurement point as Figure 2-14.

Figure 2-14 Measurement Point Setup for Power Level Accuracy Test

4287A RF LCR Meter			
1.File 2.Edit 3.View 4.Table			
STIMULUS CAL KIT COMPEN KIT COMPARATOR			
No.	Frequency	Average	Power dBm
1	1.0000 GHz	1	1.00 dBm
2	3.0000 GHz	1	0.00 dBm
3	3.0000 GHz	1	-7.90 dBm
4	300.00 MHz	1	-10.0 dBm
5	50.000 MHz	1	-20.0 dBm
6	1.0000 GHz	1	-25.0 dBm
7	10.000 MHz	1	-30.0 dBm
8	2.0000 GHz	1	-35.0 dBm
9	100.00 MHz	1	-40.0 dBm
10			
11			
12			
13			
14			
15			
16			
17			
18			
19			

1 2 3 4 5 6 7 8 EXIT

4287ase02007

15. Press **[Stml Select]**, then select the POINT NO. using keys or a mouse.

16. Select POINT 1 using keys or a mouse.

17. Input the 4287A's frequency to the power meter.
18. Press **[Trigger]** to make a measurement.
19. Subtract the 4287A's reading from the power meter reading, then record it to the performance test record.

NOTE

If the cable length is 1 m, record the result to "Power Level Accuracy Test (without Opt. 020)". If it is 2 m, record it to "Power Level Accuracy Test (with Opt. 020)".

20. Repeat Step 15 to 18 for other points.

Impedance Measurement Accuracy Test

This test verifies the 4287A's impedance measurement accuracy with a calibrated standards(16190B).

Specification

Basic Accuracy: 0.65%

NOTE

See the “Specifications and Supplemental Performance Characteristics” of the Operation Manual.

Required Equipment

Description	Recommended Model
Performance Test Kit	16190B
Calibration Kit	16195B
Test Fixture Station	p/n 04287-60121
7mm-3.5mm(m) Adapter	p/n 1250-1746
3/4 inch Torque Wrench, 136 N-cm	p/n 8710-1766

Procedure

Preparation

1. Connect the equipment as shown in Figure 2-15.

Figure 2-15 Impedance Measurement Accuracy Test

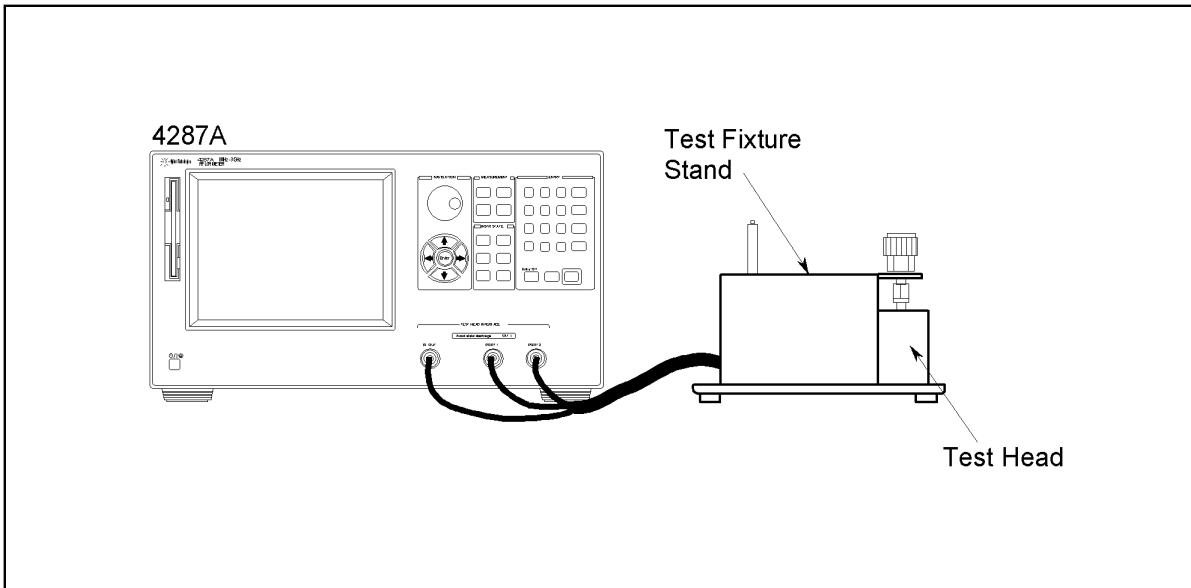

4287ase02003

2. Press **[Preset]** to preset the 4287A.

3. Set the 4287A as follows “How to Set the 4287A for Maintenance” on page 23.

Frequency	Average	Power	
1 MHz	8	1 dBm	
10 MHz			
100 MHz			
200 MHz			
300 MHz			
500 MHz			
600 MHz			
800 MHz			
1 GHz			
1.3 GHz			0 dBm
1.6 GHz			
1.8 GHz			
2.0 GHz			
2.2 GHz			
2.4 GHz			
2.6 GHz			
2.8 GHz			
3.0 GHz			

4. Press **[Meas Setup]** to show list measurement display.





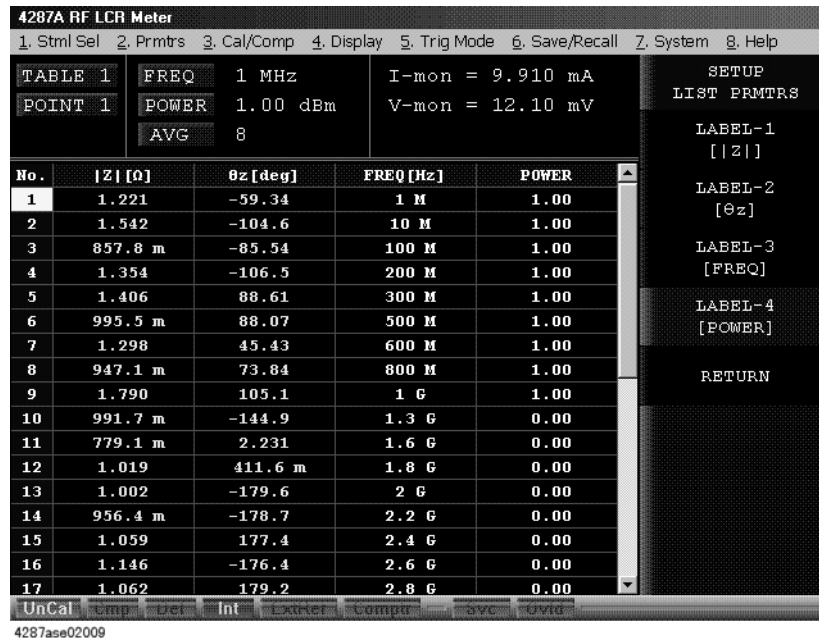









































Figure 2-16











List Measurement Display



















Maintenance

Performance Test









5. Press **[Prmtr]** to show the parameter setup softkey menu.
6. Select SETUP LIST PRMTRS using   key, then press  key.
7. Select LABEL-3 using   key, then press  key.
8. Select FREQ using   key, then press  key.
9. Press **[Prmtr]** to show the parameter setup softkey menu.
10. Select SETUP LIST PRMTRS using   key, then press  key.
11. Select LABEL-4 using   key, then press  key.
12. Select POWER using   key, then press  key.
13. The measurement display like Figure 2-16 appears.
14. Press **[Trigger Mode]**.
15. Select TRIG SOURCE using   key, then press  key.
16. Select MANUAL using   key, then press  key.
17. Press **[Cal/Compen]** to show the Cal/Compen softkey menu.
18. Select CAL DIALOG using   key, then press  key to show calibration dialog box.
19. Connect the OPEN Termination included in the 16195B to the 7 mm connector.
20. Select OPEN using   key, then press  key.
21. Connect the SHORT Termination included in the 16195B to the 7 mm connector.
22. Select SHORT using   key, then press  key.
23. Connect the 50 Ω Termination included in the 16195B to the 7 mm connector.
24. Select LOAD using   key, then press  key.
25. Select DONE using   key, then press  key.
26. Press **[Save/Recall]** to show the Save/Recall softkey menu.
27. Select SAVE STATE using   key, then press  key.
28. Press **[0]**, , then 4287A's status is saved to "0.sta" status file.
29. Press **[Setup View]** to show the measurement point setup softkey menu.
30. Set the power to -20 dBm for all measurement point.
31. Perform OPEN, SHORT, LOAD calibration as described in step 17 to 25.
32. Select DONE using   key, then press  key.
33. Press **[Save/Recall]** to show the Save/Recall softkey menu.

34. Select **SAVE STATE** using   key, then press  key.
35. Press **[-]-[2]-[0]-** , then 4287A's status is saved to “-20.sta” status file.
36. Press **[Setup View]** to show the measurement point setup softkey menu.
37. Set the power to -40 dBm for all measurement point.
38. Perform OPEN, SHORT, LOAD calibration as described in step 17 to 25.
39. Select **DONE** using   key, then press  key.
40. Press **[Save/Recall]** to show the Save/Recall softkey menu.
41. Select **SAVE STATE** using   key, then press  key.
42. Press **[-]-[4]-[0]-** , then 4287A's status is saved to “-40.sta” status file.

OPEN Termination

43. Record the OPEN termination calibration values on the calculation sheet.
44. Connect the OPEN termination to the 7mm connector.
45. Press **[Save/Recall]** to show the Save/Recall softkey menu.
46. Select **RECALL STATE** using   key, then press  key.
47. Select the file “0.sta” using     key, then press  key.
48. Press **[Prmtr]** to show the parameter setup softkey menu.
49. Select **SETUP MEAS PRMTRS** using   key, then press  key.
50. Select **PRMTR-1** using   key, then press  key.
51. Select **|Y|** using   key, then press  key.
52. Press **[Trigger]** to make a measurement.
53. Record the |Y| readings to the calculation sheet.
54. Calculate the test result according to the calculation sheet, the record it to the performance test record.

SHORT Termination

55. Record the SHORT termination calibration values on the calculation sheet.
56. Connect the SHORT termination to the 7mm connector.
57. Press **[Prmtr]** to show the parameter setup softkey menu.
58. Select **SETUP MEAS PRMTRS** using   key, then press  key.
59. Select **PRMTR-1** using   key, then press  key.
60. Select **|Z|** using   key, then press  key.
61. Press **[Trigger]** to make a measurement.

Maintenance
Performance Test

62. Record the $|Z|$ readings to the calculation sheet.
63. Calculate the test result according to the calculation sheet, the record it to the performance test record.

50 Ω Termination

64. Record the 50 Ω termination calibration values on the calculation sheet.
65. Connect the 50 Ω termination to the 7mm connector.
66. Press **[Trigger]** to make a measurement.
67. Record the $|Z|$ and θ readings to the calculation sheet.
68. Calculate the test result according to the calculation sheet, the record it to the performance test record.

10 cm airline with OPEN Termination

69. Record the 10 cm airline with OPEN termination calibration values on the calculation sheet.
70. Connect the 10 cm airline and OPEN termination to the 7mm connector, using the following procedure. (see Figure 2-17)
 - a. Fully retract the threads on the 7mm connector. Then insert the marked side tip of the airline center conductor.
 - b. Gently cover the airline center conductor with the airline outer conductor, with the logo side down. (To prevent damage, don't let the conductor scrape the edge of the outer conductor.) Mate the outer conductors. then torque the connection to 136 N-cm. (A 1/2 inch open end wrench may be necessary to hold the airline stationary.)
 - c. Gently inserts the airline center conductor into the open termination center conductor. Mate the outer conductors. Then torque the connection to 136 N-cm

Figure 2-17 10 cm Airline with OPEN Measurement Test Setup

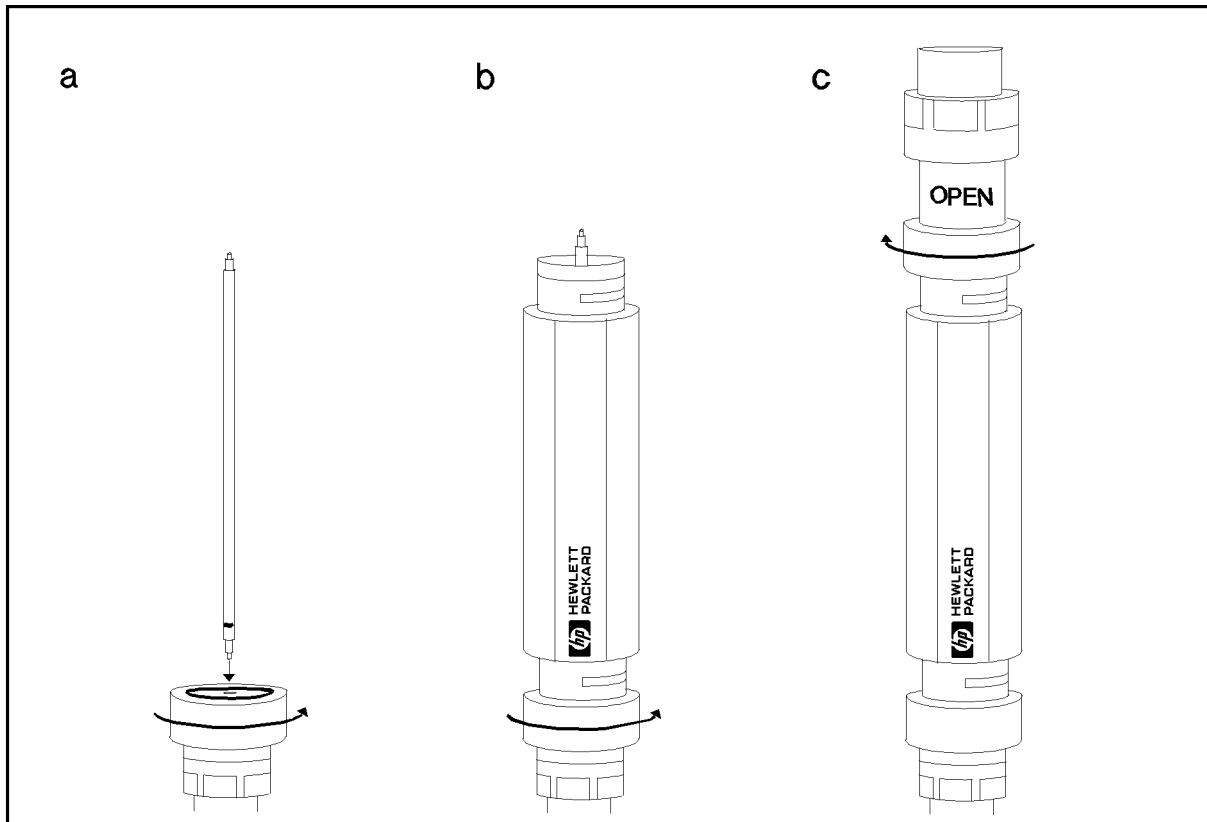









06S02005

71. Press **[Trigger]** to make a measurement.
72. Record the $|Z|$ and θ readings to the calculation sheet.

NOTE

Ignore the reading at 1.3 GHz(PPOINT 9) and 2.8 GHz(PPOINT 17)

73. Press **[Save/Recall]** to show the Save/Recall softkey menu.
74. Select RECALL STATE using   key, then press  key.
75. Select the file “-20.sta” using     key, then press  key.
76. Press **[Trigger]** to make a measurement.
77. Record the $|Z|$ and θ readings to the calculation sheet.

NOTE

Ignore the reading at 1.3 GHz(PPOINT 9) and 2.8 GHz(PPOINT 17)

78. Calculate the test result according to the calculation sheet, the record it to the performance test record.

10 cm airline with SHORT Termination

79. Record the 10 cm airline with SHORT termination calibration values on the calculation sheet.







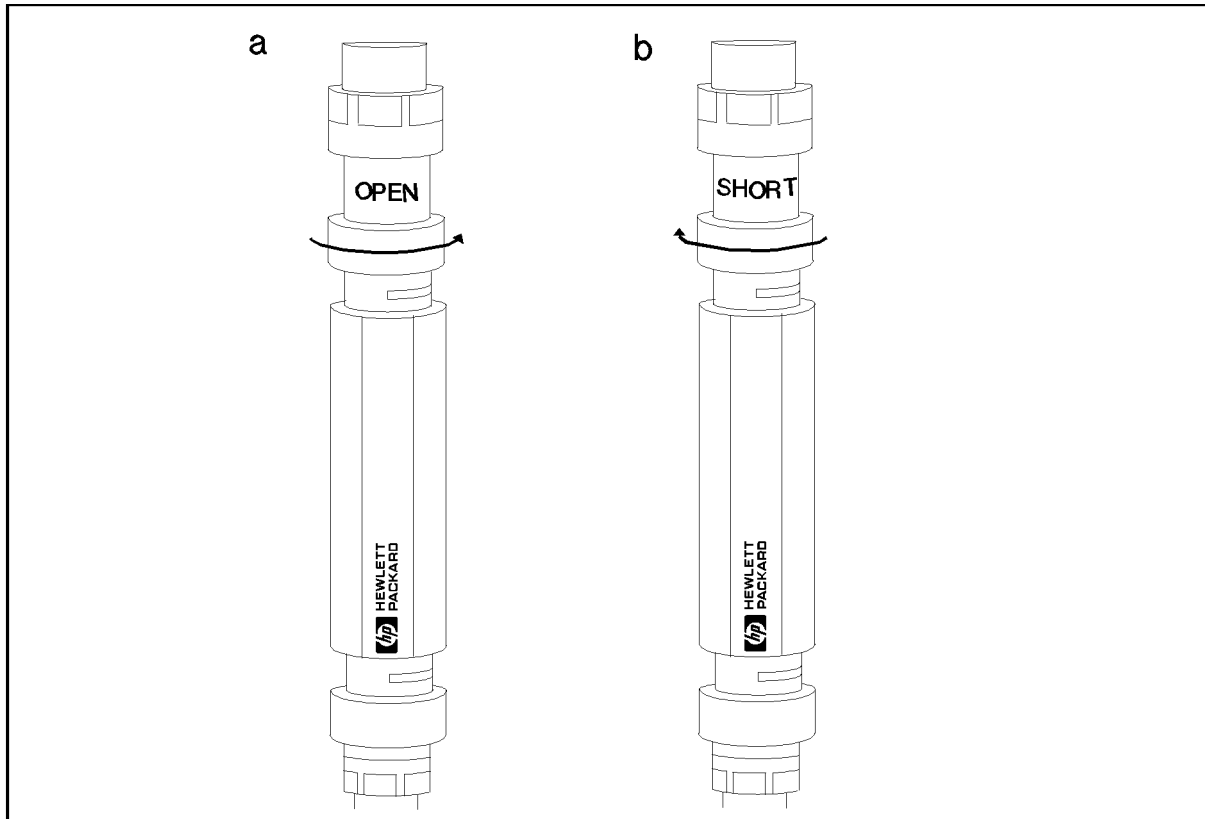

Maintenance
Performance Test

80. Connect the 10 cm airline and short termination to the 7mm connector, using the following procedure. (see Figure 2-18)
 - a. Remove the open termination from the airline.
 - b. Gently inserts the airline center conductor into the short termination center conductor. Mate the outer conductors. Then torque the connection to 136 N-cm.(A 1/2 inch open end wrench may be necessary to hold the airline stationary.)

Figure 2-18 10 cm Airline with SHORT Measurement Test Setup











C6S02006

81. Press **[Trigger]** to make a measurement.
82. Select RECALL STATE using   key, then press  key.
83. Select the file "0.sta" using     key, then press  key.
84. Record the $|Z|$ and θ readings to the calculation sheet.

NOTE

Ignore the reading at 800 MHz(PPOINT 8), 2.2 GHz(PPOINT 14) and 3.0 GHz(PPOINT 18)

85. Press **[Save/Recall]** to show the Save/Recall softkey menu.
86. Select RECALL STATE using   key, then press  key.
87. Select the file "-40.sta" using     key, then press  key.
88. Press **[Trigger]** to make a measurement.

89. Record the $|Z|$ and θ readings to the calculation sheet.
90. Calculate the test result according to the calculation sheet, the record it to the performance test record.

NOTE Ignore the reading at 800 MHz(POINT 8), 2.2 GHz(POINT 14) and 3.0 GHz(POINT 18)

Function Test

Introduction

This section provides the test procedures used to verify that the 4287A's performance characteristics are met. The function tests is recommended to be performed with the 4287A performance test.

Warm Up Time

Allow the 4287A to warm up for at least 30 minutes before you execute any of the performance tests

Ambient Conditions

Perform all function tests in ambient conditions of $23\text{ }^{\circ}\text{C} \pm 5\text{ }^{\circ}\text{C}$, $\leq 70\text{ \% RH}$.

























DC Resistance Measurement Accuracy Test

This test verifies the 4287A's impedance measurement accuracy.

Required Equipment

Description	Recommended Model
Performance Test Kit	16190B
Calibration Kit	16195B
Test Fixture Station	p/n 04287-60121
7mm-3.5mm(f) Adapter	p/n 1250-1746

Procedure

1. Press **[Preset]** to preset the 4287A.
2. Press **[Prmtr]** to show the measurement parameter setup softkey menu.
3. Select RDC MEAS using   key, then press  key to set DC resistance measurement to "ON".
4. Press **[Trigger Mode]**.
5. Select TRIG SOURCE using   key, then press  key.
6. Select MANUAL using   key, then press  key.
7. Connect the 50 Ω Termination included in the 16195B to the 4287A 7mm Connector.
8. Press **[Trigger]** to make a measurement.
9. Record "R_dc" reading to the calculation sheet.
10. Press **[Cal/Compen]** to show the Cal/Compen softkey menu.
11. Select CAL DIALOG using   key, then press  key to show calibration dialog box.
12. Connect the OPEN Termination included in the 16195B to the 7 mm connector.
13. Select OPEN using   key, then press  key.
14. Connect the SHORT Termination included in the 16195B to the 7 mm connector.
15. Select SHORT using   key, then press  key.
16. Connect the 50 Ω Termination included in the 16195B to the 7 mm connector.
17. Select LOAD using   key, then press  key.
18. Select DONE using   key, then press  key.
19. Connect the SHORT Termination included in the 16190B to the 7 mm connector.
20. Press **[Trigger]** to make a measurement.

Maintenance
Function Test

21. Record “R_dc” reading to the calculation sheet.
22. Connect the LOAD Termination included in the 16190B to the 7 mm connector.
23. Press **[Trigger]** to make a measurement.
24. Record “R_dc” reading to the calculation sheet.
25. If all readings are between the limit, check the “Pass” column.

NOTE

Check “Fail” column if any reading is out of limit.

Low Loss Capacitor Check

This test verifies the Low Loss Capacitor included in the 16195B Calibration Kit.

Required Equipment

Description	Recommended Model
Network Analyzer	8753ES
Low Loss Capacitor	Included in 16195B

Procedure

1. Press **[Preset]** to preset the network analyzer.
2. Setup the network analyzer as follows.

Parameter Setting	Operation
Conversion: Z(reflection)	[Meas]-CONVERSION-Z:refl
Format: Liner	[Format]-LIN MAG
Source Power: 0 dBm	[Power]-[0]-[×1]
Start Frequency: 5 GHz	[Start]-[5]-[G/n]
Stop Frequency: 6 GHz	[Stop]-[6]-[G/n]
IF BW: ≤ 100 Hz	[Avg]-IF BW-[1]-[0]-[0]-[×1]
Number of points: 401 or larger	[Sweep Setup]-NUMBER of POINTS-[4]-[0]-[1]-[×1]

3. Perform the S11 1 port full calibration.
4. Connect the low loss capacitor to the port 1.
5. Make a single sweep measurement.
6. Record the minimum impedance value and its frequency to calculation sheet.
7. Record the test result to the function test record.

NOTE

If the minimum impedance or the frequency is out of limit, check the fail column.

Calculating Sheet

Performance Test

Power Level Accuracy Test

Power Level	Frequency	Multimeter Reading [a]	Test Result [-16.99+20×log ₁₀ a]
-15 dBm	1 MHz	mV	dBm

Impedance Measurement Accuracy Test

16190B Calibration Value

Standard: Open Termination

Frequency	Measurement Parameter	Calibration Value	Reference Designation
1 MHz	Y	μS	CV1
10 MHz	Y	μS	CV2
100 MHz	Y	μS	CV3
200 MHz	Y	μS	CV4
300 MHz	Y	μS	CV5
500 MHz	Y	μS	CV6
600 MHz	Y	μS	CV7
800 MHz	Y	μS	CV8
1.0 GHz	Y	μS	CV9
1.3 GHz	Y	μS	CV10
1.6 GHz	Y	μS	CV11
1.8 GHz	Y	μS	CV12
2.0 GHz	Y	μS	CV13
2.2 GHz	Y	μS	CV14
2.4 GHz	Y	μS	CV15
2.6 GHz	Y	μS	CV16
2.8 GHz	Y	μS	CV17
3.0 GHz	Y	μS	CV18

Standard: Short Termination

Frequency	Measurement Parameter	Calibration Value	Reference Designation
1 MHz	Z	mΩ	CV19
10 MHz	Z	mΩ	CV20
100 MHz	Z	mΩ	CV21
200 MHz	Z	mΩ	CV22
300 MHz	Z	mΩ	CV23
500 MHz	Z	mΩ	CV24
600 MHz	Z	mΩ	CV25
800 MHz	Z	mΩ	CV26
1.0 GHz	Z	mΩ	CV27
1.3 GHz	Z	mΩ	CV28
1.6 GHz	Z	mΩ	CV29
1.8 GHz	Z	mΩ	CV30
2.0 GHz	Z	mΩ	CV31
2.2 GHz	Z	mΩ	CV32
2.4 GHz	Z	mΩ	CV33
2.6 GHz	Z	mΩ	CV34
2.8 GHz	Z	mΩ	CV35
3.0 GHz	Z	mΩ	CV36

Maintenance
Calculating Sheet

Standard: 50 Ω Termination

Frequency	Measurement Parameter	Calibration Value	Reference Designation
1 MHz	Z	Ω	CV37
	θ	mrاد	CV38
10 MHz	Z	Ω	CV39
	θ	mrاد	CV40
100 MHz	Z	Ω	CV41
	θ	mrاد	CV42
200 MHz	Z	Ω	CV43
	θ	mrاد	CV44
300 MHz	Z	Ω	CV45
	θ	mrاد	CV46
500 MHz	Z	Ω	CV47
	θ	mrاد	CV48
600 MHz	Z	Ω	CV49
	θ	mrاد	CV50
800 MHz	Z	Ω	CV51
	θ	mrاد	CV52
1.0 GHz	Z	Ω	CV53
	θ	mrاد	CV54
1.3 GHz	Z	Ω	CV55
	θ	mrاد	CV56
1.6 GHz	Z	Ω	CV57
	θ	mrاد	CV58
1.8 GHz	Z	Ω	CV59
	θ	mrاد	CV60
2.0 GHz	Z	Ω	CV61
	θ	mrاد	CV62
2.2 GHz	Z	Ω	CV63
	θ	mrاد	CV64
2.4 GHz	Z	Ω	CV65
	θ	mrاد	CV66
2.6 GHz	Z	Ω	CV67
	θ	mrاد	CV68
2.8 GHz	Z	Ω	CV69
	θ	mrاد	CV70
3.0 GHz	Z	Ω	CV71
	θ	mrاد	CV72

Standard: Airline with Open Termination

Frequency	Measurement Parameter	Calibration Value	Reference Designation
1 MHz	Z	kΩ	CV73
	θ	mrاد	CV74
10 MHz	Z	Ω	CV75
	θ	mrاد	CV76
100 MHz	Z	Ω	CV77
	θ	mrاد	CV78
200 MHz	Z	Ω	CV79
	θ	mrاد	CV80
300 MHz	Z	Ω	CV81
	θ	mrاد	CV82
500 MHz	Z	Ω	CV83
	θ	mrاد	CV84
600 MHz	Z	Ω	CV85
	θ	mrاد	CV86
800 MHz	Z	Ω	CV87
	θ	mrاد	CV88
1.0 GHz	Z	Ω	CV89
	θ	mrاد	CV90
1.6 GHz	Z	Ω	CV91
	θ	mrاد	CV92
1.8 GHz	Z	Ω	CV93
	θ	mrاد	CV94
2.0 GHz	Z	Ω	CV95
	θ	mrاد	CV96
2.2 GHz	Z	Ω	CV97
	θ	mrاد	CV98
2.4 GHz	Z	Ω	CV99
	θ	mrاد	CV100
2.6 GHz	Z	Ω	CV101
	θ	mrاد	CV102
3.0 GHz	Z	Ω	CV103
	θ	mrاد	CV104

Maintenance
Calculating Sheet

Standard: Airline with Short Termination

Frequency	Measurement Parameter	Calibration Value	Reference Designation
1 MHz	Z	Ω	CV105
	θ	mrad	CV106
10 MHz	Z	Ω	CV107
	θ	mrad	CV108
100 MHz	Z	Ω	CV109
	θ	mrad	CV110
200 MHz	Z	Ω	CV111
	θ	mrad	CV112
300 MHz	Z	Ω	CV113
	θ	mrad	CV114
500 MHz	Z	Ω	CV115
	θ	mrad	CV116
600 MHz	Z	Ω	CV117
	θ	mrad	CV118
1.0 GHz	Z	Ω	CV119
	θ	mrad	CV120
1.3 GHz	Z	Ω	CV121
	θ	mrad	CV122
1.6 GHz	Z	Ω	CV123
	θ	mrad	CV124
1.8 GHz	Z	Ω	CV125
	θ	mrad	CV126
2.0 GHz	Z	Ω	CV127
	θ	mrad	CV128
2.4 GHz	Z	Ω	CV129
	θ	mrad	CV130
2.6 GHz	Z	Ω	CV131
	θ	mrad	CV132
2.8 GHz	Z	Ω	CV133
	θ	mrad	CV134

Impedance Measurement Accuracy Test

Standard: Open
Averaging 8
Cable Length: Common to 1 m and 2 m

Freq.	Power Level	Measurement Parameter	4287A Reading [a]	Test Result Equation
1 MHz	+1 dBm	Y	μS	a-CV1
10 MHz	+1 dBm	Y	μS	a-CV2
100 MHz	+1 dBm	Y	μS	a-CV3
200 MHz	+1 dBm	Y	μS	a-CV4
300 MHz	+1 dBm	Y	μS	a-CV5
500 MHz	+1 dBm	Y	μS	a-CV6
600 MHz	+1 dBm	Y	μS	a-CV7
800 MHz	+1 dBm	Y	μS	a-CV8
1.0 GHz	+1 dBm	Y	μS	a-CV9
1.3 GHz	0 dBm	Y	μS	a-CV10
1.6 GHz	0 dBm	Y	μS	a-CV11
1.8 GHz	0 dBm	Y	μS	a-CV12
2.0 GHz	0 dBm	Y	μS	a-CV13
2.2 GHz	0 dBm	Y	μS	a-CV14
2.4 GHz	0 dBm	Y	μS	a-CV15
2.6 GHz	0 dBm	Y	μS	a-CV16
2.8 GHz	0 dBm	Y	μS	a-CV17
3.0 GHz	0 dBm	Y	μS	a-CV18

Maintenance
Calculating Sheet

Standard: Short
Averaging: 8
Cable Length: Common to 1 m and 2 m

Freq.	Power Level	Measurement Parameter	4287A Reading [a]	Test Result Equation
1 MHz	+1 dBm	Z	mΩ	a-CV19
10 MHz	+1 dBm	Z	mΩ	a-CV20
100 MHz	+1 dBm	Z	mΩ	a-CV21
200 MHz	+1 dBm	Z	mΩ	a-CV22
300 MHz	+1 dBm	Z	mΩ	a-CV23
500 MHz	+1 dBm	Z	mΩ	a-CV24
600 MHz	+1 dBm	Z	mΩ	a-CV25
800 MHz	+1 dBm	Z	mΩ	a-CV26
1.0 GHz	+1 dBm	Z	mΩ	a-CV27
1.3 GHz	0 dBm	Z	mΩ	a-CV28
1.6 GHz	0 dBm	Z	mΩ	a-CV29
1.8 GHz	0 dBm	Z	mΩ	a-CV30
2.0 GHz	0 dBm	Z	mΩ	a-CV31
2.2 GHz	0 dBm	Z	mΩ	a-CV32
2.4 GHz	0 dBm	Z	mΩ	a-CV33
2.6 GHz	0 dBm	Z	mΩ	a-CV34
2.8 GHz	0 dBm	Z	mΩ	a-CV35
3.0 GHz	0 dBm	Z	mΩ	a-CV36

Standard: 50 Ω
 Averaging 8
 Cable Length: Common to 1 m and 2 m

Freq.	Power Level	Measurement Parameter	4287A Reading [a]	Test Result Equation
1 MHz	+1 dBm	Z	Ω	a-CV37
	+1 dBm	θ	mrad	a-CV38
10 MHz	+1 dBm	Z	Ω	a-CV39
	+1 dBm	θ	mrad	a-CV40
100 MHz	+1 dBm	Z	Ω	a-CV41
	+1 dBm	θ	mrad	a-CV42
200 MHz	+1 dBm	Z	Ω	a-CV43
	+1 dBm	θ	mrad	a-CV44
300 MHz	+1 dBm	Z	Ω	a-CV45
	+1 dBm	θ	mrad	a-CV46
500 MHz	+1 dBm	Z	Ω	a-CV47
	+1 dBm	θ	mrad	a-CV48
600 MHz	+1 dBm	Z	Ω	a-CV49
	+1 dBm	θ	mrad	a-CV50
800 MHz	+1 dBm	Z	Ω	a-CV51
	+1 dBm	θ	mrad	a-CV52
1.0 GHz	+1 dBm	Z	Ω	a-CV53
	+1 dBm	θ	mrad	a-CV54
1.3 GHz	0 dBm	Z	Ω	a-CV55
	0 dBm	θ	mrad	a-CV56
1.6 GHz	0 dBm	Z	Ω	a-CV57
	0 dBm	θ	mrad	a-CV58
1.8 GHz	0 dBm	Z	Ω	a-CV59
	0 dBm	θ	mrad	a-CV60
2.0 GHz	0 dBm	Z	Ω	a-CV61
	0 dBm	θ	mrad	a-CV62
2.2 GHz	0 dBm	Z	Ω	a-CV63
	0 dBm	θ	mrad	a-CV64
2.4 GHz	0 dBm	Z	Ω	a-CV65
	0 dBm	θ	mrad	a-CV66
2.6 GHz	0 dBm	Z	Ω	a-CV67
	0 dBm	θ	mrad	a-CV68
2.8 GHz	0 dBm	Z	Ω	a-CV69
	0 dBm	θ	mrad	a-CV70
3.0 GHz	0 dBm	Z	Ω	a-CV71
	0 dBm	θ	mrad	a-CV72

Maintenance
Calculating Sheet

Standard: Airline with Open
Averaging: 8
Cable Length: Common to 1 m and 2 m

Freq.	Power Level	Measurement Parameter	4287A Reading [a]	Test Result Equation
1 MHz	+1 dBm	Z	kΩ	a-CV73
	+1 dBm	θ	mrad	a-CV74
10 MHz	+1 dBm	Z	Ω	a-CV75
	+1 dBm	θ	mrad	a-CV76
100 MHz	+1 dBm	Z	Ω	a-CV77
	+1 dBm	θ	mrad	a-CV78
200 MHz	+1 dBm	Z	Ω	a-CV79
	+1 dBm	θ	mrad	a-CV80
300 MHz	+1 dBm	Z	Ω	a-CV81
	+1 dBm	θ	mrad	a-CV82
500 MHz	+1 dBm	Z	Ω	a-CV83
	+1 dBm	θ	mrad	a-CV84
600 MHz	+1 dBm	Z	Ω	a-CV85
	+1 dBm	θ	mrad	a-CV86
800 MHz	+1 dBm	Z	Ω	a-CV87
	+1 dBm	θ	mrad	a-CV88
1.0 GHz	+1 dBm	Z	Ω	a-CV89
	+1 dBm	θ	mrad	a-CV90
1.6 GHz	0 dBm	Z	Ω	a-CV91
	0 dBm	θ	mrad	a-CV92
1.8 GHz	0 dBm	Z	Ω	a-CV93
	0 dBm	θ	mrad	a-CV94
2.0 GHz	0 dBm	Z	Ω	a-CV95
	0 dBm	θ	mrad	a-CV96
2.2 GHz	0 dBm	Z	Ω	a-CV97
	0 dBm	θ	mrad	a-CV98
2.4 GHz	0 dBm	Z	Ω	a-CV99
	0 dBm	θ	mrad	a-CV100
2.6 GHz	0 dBm	Z	Ω	a-CV101
	0 dBm	θ	mrad	a-CV102
3.0 GHz	0 dBm	Z	Ω	a-CV103
	0 dBm	θ	mrad	a-CV104

Standard: Airline with Open
Averaging 1
Cable Length: Common to 1 m and 2 m

Freq.	Power Level	Measurement Parameter	4287A Reading [a]	Test Result Equation
1 MHz	-20 dBm	Z	k Ω	a-CV73
	-20 dBm	θ	mrad	a-CV74
10 MHz	-20 dBm	Z	Ω	a-CV75
	-20 dBm	θ	mrad	a-CV76
100 MHz	-20 dBm	Z	Ω	a-CV77
	-20 dBm	θ	mrad	a-CV78
200 MHz	-20 dBm	Z	Ω	a-CV79
	-20 dBm	θ	mrad	a-CV80
300 MHz	-20 dBm	Z	Ω	a-CV81
	-20 dBm	θ	mrad	a-CV82
500 MHz	-20 dBm	Z	Ω	a-CV83
	-20 dBm	θ	mrad	a-CV84
600 MHz	-20 dBm	Z	Ω	a-CV85
	-20 dBm	θ	mrad	a-CV86
800 MHz	-20 dBm	Z	Ω	a-CV87
	-20 dBm	θ	mrad	a-CV88
1.0 GHz	-20 dBm	Z	Ω	a-CV89
	-20 dBm	θ	mrad	a-CV90
1.6 GHz	-20 dBm	Z	Ω	a-CV91
	-20 dBm	θ	mrad	a-CV92
1.8 GHz	-20 dBm	Z	Ω	a-CV93
	-20 dBm	θ	mrad	a-CV94
2.0 GHz	-20 dBm	Z	Ω	a-CV95
	-20 dBm	θ	mrad	a-CV96
2.2 GHz	-20 dBm	Z	Ω	a-CV97
	-20 dBm	θ	mrad	a-CV98
2.4 GHz	-20 dBm	Z	Ω	a-CV99
	-20 dBm	θ	mrad	a-CV100
2.6 GHz	-20 dBm	Z	Ω	a-CV101
	-20 dBm	θ	mrad	a-CV102
3.0 GHz	-20 dBm	Z	Ω	a-CV103
	-20 dBm	θ	mrad	a-CV104

Maintenance
Calculating Sheet

Standard: Airline with Short
Averaging 8
Cable Length: Common to 1 m and 2 m

Freq.	Power Level	Measurement Parameter	4287A Reading [a]	Test Result Equation
1 MHz	+1 dBm	Z	Ω	a-CV105
	+1 dBm	θ	mrad	a-CV106
10 MHz	+1 dBm	Z	Ω	a-CV107
	+1 dBm	θ	mrad	a-CV108
100 MHz	+1 dBm	Z	Ω	a-CV109
	+1 dBm	θ	mrad	a-CV110
200 MHz	+1 dBm	Z	Ω	a-CV111
	+1 dBm	θ	mrad	a-CV112
300 MHz	+1 dBm	Z	Ω	a-CV113
	+1 dBm	θ	mrad	a-CV114
500 MHz	+1 dBm	Z	Ω	a-CV115
	+1 dBm	θ	mrad	a-CV116
600 MHz	+1 dBm	Z	Ω	a-CV117
	+1 dBm	θ	mrad	a-CV118
1.0 GHz	+1 dBm	Z	Ω	a-CV119
	+1 dBm	θ	mrad	a-CV120
1.3 GHz	+1 dBm	Z	Ω	a-CV121
	+1 dBm	θ	mrad	a-CV122
1.6 GHz	0 dBm	Z	Ω	a-CV123
	0 dBm	θ	mrad	a-CV124
1.8 GHz	0 dBm	Z	Ω	a-CV125
	0 dBm	θ	mrad	a-CV126
2.0 GHz	0 dBm	Z	Ω	a-CV127
	0 dBm	θ	mrad	a-CV128
2.4 GHz	0 dBm	Z	Ω	a-CV129
	0 dBm	θ	mrad	a-CV130
2.6 GHz	0 dBm	Z	Ω	a-CV131
	0 dBm	θ	mrad	a-CV132
2.8 GHz	0 dBm	Z	Ω	a-CV133
	0 dBm	θ	mrad	a-CV134

Standard: Airline with Short
Averaging 1
Cable Length: Common to 1 m and 2 m

Freq.	Power Level	Measurement Parameter	4287A Reading [a]	Test Result Equation
1 MHz	-40 dBm	Z	Ω	a-CV105
	-40 dBm	θ	mrad	a-CV106
10 MHz	-40 dBm	Z	Ω	a-CV107
	-40 dBm	θ	mrad	a-CV108
100 MHz	-40 dBm	Z	Ω	a-CV109
	-40 dBm	θ	mrad	a-CV110
200 MHz	-40 dBm	Z	Ω	a-CV111
	-40 dBm	θ	mrad	a-CV112
300 MHz	-40 dBm	Z	Ω	a-CV113
	-40 dBm	θ	mrad	a-CV114
500 MHz	-40 dBm	Z	Ω	a-CV115
	-40 dBm	θ	mrad	a-CV116
600 MHz	-40 dBm	Z	Ω	a-CV117
	-40 dBm	θ	mrad	a-CV118
1.0 GHz	-40 dBm	Z	Ω	a-CV119
	-40 dBm	θ	mrad	a-CV120
1.3 GHz	-40 dBm	Z	Ω	a-CV121
	-40 dBm	θ	mrad	a-CV122
1.6 GHz	-40 dBm	Z	Ω	a-CV123
	-40 dBm	θ	mrad	a-CV124
1.8 GHz	-40 dBm	Z	Ω	a-CV125
	-40 dBm	θ	mrad	a-CV126
2.0 GHz	-40 dBm	Z	Ω	a-CV127
	-40 dBm	θ	mrad	a-CV128
2.4 GHz	-40 dBm	Z	Ω	a-CV129
	-40 dBm	θ	mrad	a-CV130
2.6 GHz	-40 dBm	Z	Ω	a-CV131
	-40 dBm	θ	mrad	a-CV132
2.8 GHz	-40 dBm	Z	Ω	a-CV133
	-40 dBm	θ	mrad	a-CV134

Function Test

DC Resistance Measurement Accuracy Test

Termination	Lower Limit	Reading	Upper Limit
50 Ω (with 16195B)	40.0 Ω	Ω	60.0 Ω
Short(with 16190B)	0 Ω	m Ω	50 m Ω
50 Ω (with 16190B)	49.2 Ω	Ω	50.8 Ω

Low Loss Capacitor Test

Description	Lower Limit	Reading	Upper Limit
Minimum Impedance	0 Ω	m Ω	100 m Ω
Frequency	5.2 GHz	GHz	5.8 GHz

Test Record

Performance Test Record

Agilent Technologies 4287A RF LCR Meter

Mainframe: Serial No.		Test Date	
Test Head: Serial No.		Temperature	°C
Calibration Kit Serial No.		Humidity	%RH
Cable Length:	1 m	Tested by	

Frequency Accuracy Test

Cable Length: Common to 1 m and 2 m

Frequency	Test Limit	Test Result	Measurement Uncertainty
1 MHz	±10 Hz	Hz	±0.21 Hz
3 GHz	±30 kHz	kHz	±0.64 kHz

Power Level Accuracy Test (without Opt. 020)

Cable Length: 1 m
Frequency: ≥ 10 MHz

Power Level	Frequency	Test Limit	Test Result	Measurement Uncertainty
1 dBm	1 GHz	±2.00 dB	dB	±0.28 dB
0 dBm	3 GHz	±3.00 dB	dB	±0.41 dB
-7.9 dBm	3 GHz	±3.00 dB	dB	±0.41 dB
-10 dBm	300 MHz	±2.00 dB	dB	±0.28 dB
-20 dBm	50 MHz	±2.00 dB	dB	±0.28 dB
-25 dBm	1 GHz	±2.00 dB	dB	±0.28 dB
-30 dBm	10 MHz	±2.00 dB	dB	±0.33 dB
-35 dBm	2 GHz	±3.00 dB	dB	±0.28 dB
-40 dBm	100 MHz	±2.00 dB	dB	±0.28 dB

Cable Length: 1 m
Frequency: 1 MHz

Power Level	Frequency	Test Limit	Test Result	Measurement Uncertainty
-15 dBm	1 MHz	±2.00 dB	dB	±0.11 dB

Maintenance
Test Record

Power Level Accuracy Test (with Opt. 020)

Cable Length: 2 m
Frequency: ≥ 10 MHz

Power Level	Frequency	Test Limit	Test Result	Measurement Uncertainty
1 dBm	1 GHz	± 3.00 dB	dB	± 0.28 dB
0 dBm	3 GHz	± 4.00 dB	dB	± 0.41 dB
-7.9 dBm	3 GHz	± 4.00 dB	dB	± 0.41 dB
-10 dBm	300 MHz	± 3.00 dB	dB	± 0.28 dB
-20 dBm	50 MHz	± 3.00 dB	dB	± 0.28 dB
-25 dBm	1 GHz	± 3.00 dB	dB	± 0.28 dB
-30 dBm	10 MHz	± 3.00 dB	dB	± 0.33 dB
-35 dBm	2 GHz	± 4.00 dB	dB	± 0.28 dB
-40 dBm	100 MHz	± 3.00 dB	dB	± 0.28 dB

Cable Length: 2 m
Frequency: 1 MHz

Power Level	Frequency	Test Limit	Test Result	Measurement Uncertainty
-15 dBm	1 MHz	± 3.00 dB	dB	± 0.11 dB

Impedance Measurement Accuracy Test

Standard: Open
Averaging: 8
Cable Length: Common to 1 m and 2 m

Frequency	Power Level	Measurement Parameter	Test Limit	Test Result	Measurement Uncertainty
1 MHz	+1 dBm	Y	±30.2 μS	μS	±0.03 μS
10 MHz	+1 dBm	Y	±31.8 μS	μS	±0.32 μS
100 MHz	+1 dBm	Y	±47.6 μS	μS	±3.2 μS
200 MHz	+1 dBm	Y	±66.4 μS	μS	±6.5 μS
300 MHz	+1 dBm	Y	±84.7 μS	μS	±9.9 μS
500 MHz	+1 dBm	Y	±122 μS	μS	±16 μS
600 MHz	+1 dBm	Y	±150 μS	μS	±21 μS
800 MHz	+1 dBm	Y	±192 μS	μS	±27 μS
1.0 GHz	+1 dBm	Y	±236 μS	μS	±35 μS
1.3 GHz	0 dBm	Y	±374 μS	μS	±46 μS
1.6 GHz	0 dBm	Y	±468 μS	μS	±61 μS
1.8 GHz	0 dBm	Y	±535 μS	μS	±70 μS
2.0 GHz	0 dBm	Y	±815 μS	μS	±126 μS
2.2 GHz	0 dBm	Y	±917 μS	μS	±140 μS
2.4 GHz	0 dBm	Y	±1027 μS	μS	±156 μS
2.6 GHz	0 dBm	Y	±1146 μS	μS	±172 μS
2.8 GHz	0 dBm	Y	±1277 μS	μS	±187 μS
3.0 GHz	0 dBm	Y	±1420 μS	μS	±204 μS

Maintenance
Test Record

Standard: Short
Averaging: 8
Cable Length: Common to 1 m and 2 m

Frequency	Power Level	Measurement Parameter	Test Limit	Test Result	Measurement Uncertainty
1 MHz	+1 dBm	Z	±20.5 mΩ	mΩ	±2.5 mΩ
10 MHz	+1 dBm	Z	±25.0 mΩ	mΩ	±3.5 mΩ
100 MHz	+1 dBm	Z	±70.0 mΩ	mΩ	±14 mΩ
200 MHz	+1 dBm	Z	±120 mΩ	mΩ	±25 mΩ
300 MHz	+1 dBm	Z	±170 mΩ	mΩ	±30 mΩ
500 MHz	+1 dBm	Z	±270 mΩ	mΩ	±50 mΩ
600 MHz	+1 dBm	Z	±320 mΩ	mΩ	±50 mΩ
800 MHz	+1 dBm	Z	±420 mΩ	mΩ	±50 mΩ
1.0 GHz	+1 dBm	Z	±520 mΩ	mΩ	±50 mΩ
1.3 GHz	0 dBm	Z	±670 mΩ	mΩ	±100 mΩ
1.6 GHz	0 dBm	Z	±820 mΩ	mΩ	±100 mΩ
1.8 GHz	0 dBm	Z	±920 mΩ	mΩ	±100 mΩ
2.0 GHz	0 dBm	Z	±1020 mΩ	mΩ	±200 mΩ
2.2 GHz	0 dBm	Z	±1120 mΩ	mΩ	±200 mΩ
2.4 GHz	0 dBm	Z	±1220 mΩ	mΩ	±200 mΩ
2.6 GHz	0 dBm	Z	±1320 mΩ	mΩ	±200 mΩ
2.8 GHz	0 dBm	Z	±1420 mΩ	mΩ	±200 mΩ
3.0 GHz	0 dBm	Z	±1520 mΩ	mΩ	±200 mΩ

Standard: 50 Ω
 Averaging: 8
 Cable Length: Common to 1 m and 2 m

Frequency	Power Level	Measurement Parameter	Test Limit	Test Result	Measurement Uncertainty
1 MHz	+1 dBm	Z	$\pm 0.42 \Omega$	Ω	$\pm 0.09 \Omega$
		θ	$\pm 8.4 \text{ mrad}$	mrad	$\pm 1.8 \text{ mrad}$
10 MHz	+1 dBm	Z	$\pm 0.43 \Omega$	Ω	$\pm 0.09 \Omega$
		θ	$\pm 8.6 \text{ mrad}$	mrad	$\pm 1.8 \text{ mrad}$
100 MHz	+1 dBm	Z	$\pm 0.51 \Omega$	Ω	$\pm 0.09 \Omega$
		θ	$\pm 10.2 \text{ mrad}$	mrad	$\pm 1.8 \text{ mrad}$
200 MHz	+1 dBm	Z	$\pm 0.67 \Omega$	Ω	$\pm 0.11 \Omega$
		θ	$\pm 13.4 \text{ mrad}$	mrad	$\pm 2.3 \text{ mrad}$
300 MHz	+1 dBm	Z	$\pm 0.76 \Omega$	Ω	$\pm 0.14 \Omega$
		θ	$\pm 15.2 \text{ mrad}$	mrad	$\pm 2.7 \text{ mrad}$
500 MHz	+1 dBm	Z	$\pm 0.93 \Omega$	Ω	$\pm 0.18 \Omega$
		θ	$\pm 18.6 \text{ mrad}$	mrad	$\pm 3.7 \text{ mrad}$
600 MHz	+1 dBm	Z	$\pm 1.22 \Omega$	Ω	$\pm 0.23 \Omega$
		θ	$\pm 24.4 \text{ mrad}$	mrad	$\pm 4.6 \text{ mrad}$
800 MHz	+1 dBm	Z	$\pm 1.40 \Omega$	Ω	$\pm 0.23 \Omega$
		θ	$\pm 27.9 \text{ mrad}$	mrad	$\pm 4.6 \text{ mrad}$
1.0 GHz	+1 dBm	Z	$\pm 1.57 \Omega$	Ω	$\pm 0.23 \Omega$
		θ	$\pm 31.4 \text{ mrad}$	mrad	$\pm 4.6 \text{ mrad}$
1.3 GHz	0 dBm	Z	$\pm 2.49 \Omega$	Ω	$\pm 0.24 \Omega$
		θ	$\pm 49.7 \text{ mrad}$	mrad	$\pm 4.8 \text{ mrad}$
1.6 GHz	0 dBm	Z	$\pm 2.75 \Omega$	Ω	$\pm 0.24 \Omega$
		θ	$\pm 54.9 \text{ mrad}$	mrad	$\pm 4.8 \text{ mrad}$
1.8 GHz	0 dBm	Z	$\pm 2.92 \Omega$	Ω	$\pm 0.23 \Omega$
		θ	$\pm 58.4 \text{ mrad}$	mrad	$\pm 4.6 \text{ mrad}$
2.0 GHz	0 dBm	Z	$\pm 4.34 \Omega$	Ω	$\pm 0.50 \Omega$
		θ	$\pm 86.9 \text{ mrad}$	mrad	$\pm 10.1 \text{ mrad}$
2.2 GHz	0 dBm	Z	$\pm 4.52 \Omega$	Ω	$\pm 0.51 \Omega$
		θ	$\pm 90.4 \text{ mrad}$	mrad	$\pm 10.3 \text{ mrad}$
2.4 GHz	0 dBm	Z	$\pm 4.69 \Omega$	Ω	$\pm 0.50 \Omega$
		θ	$\pm 93.9 \text{ mrad}$	mrad	$\pm 10.1 \text{ mrad}$
2.6 GHz	0 dBm	Z	$\pm 4.87 \Omega$	Ω	$\pm 0.51 \Omega$
		θ	$\pm 97.4 \text{ mrad}$	mrad	$\pm 10.2 \text{ mrad}$
2.8 GHz	0 dBm	Z	$\pm 5.04 \Omega$	Ω	$\pm 0.51 \Omega$
		θ	$\pm 101 \text{ mrad}$	mrad	$\pm 10.2 \text{ mrad}$
3.0 GHz	0 dBm	Z	$\pm 5.22 \Omega$	Ω	$\pm 0.50 \Omega$
		θ	$\pm 104 \text{ mrad}$	mrad	$\pm 10.1 \text{ mrad}$

Maintenance
Test Record

Standard: 10 cm Airline with Open
Averaging: 8
Cable Length: Common to 1 m and 2 m

Frequency	Power Level	Measurement Parameter	Test Limit	Test Result	Measurement Uncertainty
1 MHz	+1 dBm	Z	±14.5 kΩ	kΩ	±42 Ω
		θ	±664 mrad	mrad	±1.9 mrad
10 MHz	+1 dBm	Z	±164 Ω	Ω	±4.2 Ω
		θ	±75.2 mrad	mrad	±1.9 mrad
100 MHz	+1 dBm	Z	±3.53 Ω	Ω	±0.41 Ω
		θ	±16.5 mrad	mrad	±1.9 mrad
200 MHz	+1 dBm	Z	±1.55 Ω	Ω	±0.22 Ω
		θ	±15.3 mrad	mrad	±2.2 mrad
300 MHz	+1 dBm	Z	±0.93 Ω	Ω	±0.16 Ω
		θ	±15.4 mrad	mrad	±2.6 mrad
500 MHz	+1 dBm	Z	±0.50 Ω	Ω	±0.09 Ω
		θ	±22.3 mrad	mrad	±3.8 mrad
600 MHz	+1 dBm	Z	±0.45 Ω	Ω	±0.08 Ω
		θ	±45.8 mrad	mrad	±8.6 mrad
800 MHz	+1 dBm	Z	±0.61 Ω	Ω	±0.12 Ω
		θ	±44.9 mrad	mrad	±8.8 mrad
1.0 GHz	+1 dBm	Z	±1.40 Ω	Ω	±0.23 Ω
		θ	±31.7 mrad	mrad	±5.2 mrad
1.6 GHz	0 dBm	Z	±4.95 Ω	Ω	±0.72 Ω
		θ	±57.7 mrad	mrad	±8.4 mrad
1.8 GHz	0 dBm	Z	±2.08 Ω	Ω	±0.29 Ω
		θ	±62.7 mrad	mrad	±8.6 mrad
2.0 GHz	0 dBm	Z	±1.35 Ω	Ω	±0.09 Ω
		θ	±213 mrad	mrad	±15.0 mrad
2.2 GHz	0 dBm	Z	±2.09 Ω	Ω	±0.23 Ω
		θ	±121 mrad	mrad	±13.2 mrad
2.4 GHz	0 dBm	Z	±4.75 Ω	Ω	±0.65 Ω
		θ	±93.8 mrad	mrad	±12.8 mrad
2.6 GHz	0 dBm	Z	±18.3 Ω	Ω	±2.2 Ω
		θ	±122 mrad	mrad	±14.8 mrad
3.0 GHz	0 dBm	Z	±7.84 Ω	Ω	±1.0 Ω
		θ	±106 mrad	mrad	±14.2 mrad

Standard: 10 cm Airline with Open
Averaging: 1
Cable Length: Common to 1 m and 2 m

Frequency	Power Level	Measurement Parameter	Test Limit	Test Result	Measurement Uncertainty
1 MHz	-20 dBm	Z	±24.0 kΩ	kΩ	±42 Ω
		θ	±1101 mrad	mrاد	±1.9 mrad
10 MHz	-20 dBm	Z	±259 Ω	Ω	±4.2 Ω
		θ	±119 mrad	mrاد	±1.9 mrad
100 MHz	-20 dBm	Z	±4.48 Ω	Ω	±0.41 Ω
		θ	±20.9 mrad	mrاد	±1.9 mrad
200 MHz	-20 dBm	Z	±1.78 Ω	Ω	±0.22 Ω
		θ	±17.6 mrad	mrاد	±2.2 mrad
300 MHz	-20 dBm	Z	±1.04 Ω	Ω	±0.16 Ω
		θ	±17.1 mrad	mrاد	±2.6 mrad
500 MHz	-20 dBm	Z	±0.54 Ω	Ω	±0.09 Ω
		θ	±24.1 mrad	mrاد	±3.8 mrad
600 MHz	-20 dBm	Z	±0.48 Ω	Ω	±0.08 Ω
		θ	±49.0 mrad	mrاد	±8.6 mrad
800 MHz	-20 dBm	Z	±0.64 Ω	Ω	±0.12 Ω
		θ	±47.4 mrad	mrاد	±8.8 mrad
1.0 GHz	-20 dBm	Z	±1.47 Ω	Ω	±0.23 Ω
		θ	±33.3 mrad	mrاد	±5.2 mrad
1.6 GHz	-20 dBm	Z	±5.13 Ω	Ω	±0.72 Ω
		θ	±59.8 mrad	mrاد	±8.4 mrad
1.8 GHz	-20 dBm	Z	±2.13 Ω	Ω	±0.29 Ω
		θ	±64.3 mrad	mrاد	±8.6 mrad
2.0 GHz	-20 dBm	Z	±1.38 Ω	Ω	±0.09 Ω
		θ	±218 mrad	mrاد	±15.0 mrad
2.2 GHz	-20 dBm	Z	±2.13 Ω	Ω	±0.23 Ω
		θ	±123 mrad	mrاد	±13.2 mrad
2.4 GHz	-20 dBm	Z	±4.83 Ω	Ω	±0.65 Ω
		θ	±95.4 mrad	mrاد	±12.8 mrad
2.6 GHz	-20 dBm	Z	±18.8 Ω	Ω	±2.2 Ω
		θ	±125 mrad	mrاد	±14.8 mrad
3.0 GHz	-20 dBm	Z	±7.98 Ω	Ω	±1.0 Ω
		θ	±108 mrad	mrاد	±14.2 mrad

Maintenance
Test Record

Standard: 10 cm Airline with Short
Averaging: 8
Cable Length: Common to 1 m and 2 m

Frequency	Power Level	Measurement Parameter	Test Limit	Test Result	Measurement Uncertainty
1 MHz	+1 dBm	Z	±0.021 Ω	Ω	±0.002 Ω
		θ	±187 mrad	mrad	±15.0 mrad
10 MHz	+1 dBm	Z	±0.032 Ω	Ω	±0.004 Ω
		θ	±29.8 mrad	mrad	±4.0 mrad
100 MHz	+1 dBm	Z	±0.14 Ω	Ω	±0.03 Ω
		θ	±13.5 mrad	mrad	±2.5 mrad
200 MHz	+1 dBm	Z	±0.33 Ω	Ω	±0.07 Ω
		θ	±14.7 mrad	mrad	±3.0 mrad
300 MHz	+1 dBm	Z	±0.56 Ω	Ω	±0.11 Ω
		θ	±15.4 mrad	mrad	±3.0 mrad
500 MHz	+1 dBm	Z	±1.77 Ω	Ω	±0.30 Ω
		θ	±20.3 mrad	mrad	±3.5 mrad
600 MHz	+1 dBm	Z	±5.09 Ω	Ω	±0.77 Ω
		θ	±32.7 mrad	mrad	±5.0 mrad
1.0 GHz	+1 dBm	Z	±2.89 Ω	Ω	±0.46 Ω
		θ	±33.5 mrad	mrad	±5.3 mrad
1.3 GHz	+1 dBm	Z	±1.33 Ω	Ω	±0.19 Ω
		θ	±60.3 mrad	mrad	±8.5 mrad
1.6 GHz	0 dBm	Z	±1.12 Ω	Ω	±0.12 Ω
		θ	±103 mrad	mrad	±11.2 mrad
1.8 GHz	0 dBm	Z	±2.24 Ω	Ω	±0.31 Ω
		θ	±61.1 mrad	mrad	±8.5 mrad
2.0 GHz	0 dBm	Z	±7.94 Ω	Ω	±0.93 Ω
		θ	±90.4 mrad	mrad	±10.6 mrad
2.4 GHz	0 dBm	Z	±17.7 Ω	Ω	±2.11 Ω
		θ	±117 mrad	mrad	±14.0 mrad
2.6 GHz	0 dBm	Z	±5.34 Ω	Ω	±0.75 Ω
		θ	±97.1 mrad	mrad	±13.6 mrad
2.8 GHz	0 dBm	Z	±2.74 Ω	Ω	±0.31 Ω
		θ	±125 mrad	mrad	±13.9 mrad

Standard: 10 cm Airline with Short
Averaging: 1
Cable Length: Common to 1 m and 2 m

Frequency	Power Level	Measurement Parameter	Test Limit	Test Result	Measurement Uncertainty
1 MHz	-40 dBm	Z	$\pm 0.102 \Omega$	Ω	$\pm 0.002 \Omega$
		θ	$\pm 896 \text{ mrad}$	mrad	$\pm 15.0 \text{ mrad}$
10 MHz	-40 dBm	Z	$\pm 0.116 \Omega$	Ω	$\pm 0.004 \Omega$
		θ	$\pm 108 \text{ mrad}$	mrad	$\pm 4.0 \text{ mrad}$
100 MHz	-40 dBm	Z	$\pm 0.27 \Omega$	Ω	$\pm 0.03 \Omega$
		θ	$\pm 25.2 \text{ mrad}$	mrad	$\pm 2.5 \text{ mrad}$
200 MHz	-40 dBm	Z	$\pm 0.53 \Omega$	Ω	$\pm 0.07 \Omega$
		θ	$\pm 23.8 \text{ mrad}$	mrad	$\pm 3.0 \text{ mrad}$
300 MHz	-40 dBm	Z	$\pm 0.88 \Omega$	Ω	$\pm 0.11 \Omega$
		θ	$\pm 24.1 \text{ mrad}$	mrad	$\pm 3.0 \text{ mrad}$
500 MHz	-40 dBm	Z	$\pm 2.73 \Omega$	Ω	$\pm 0.30 \Omega$
		θ	$\pm 31.3 \text{ mrad}$	mrad	$\pm 3.5 \text{ mrad}$
600 MHz	-40 dBm	Z	$\pm 6.86 \Omega$	Ω	$\pm 0.77 \Omega$
		θ	$\pm 44.1 \text{ mrad}$	mrad	$\pm 5.0 \text{ mrad}$
1.0 GHz	-40 dBm	Z	$\pm 3.49 \Omega$	Ω	$\pm 0.46 \Omega$
		θ	$\pm 40.5 \text{ mrad}$	mrad	$\pm 5.3 \text{ mrad}$
1.3 GHz	-40 dBm	Z	$\pm 1.45 \Omega$	Ω	$\pm 0.19 \Omega$
		θ	$\pm 65.5 \text{ mrad}$	mrad	$\pm 8.5 \text{ mrad}$
1.6 GHz	-40 dBm	Z	$\pm 1.21 \Omega$	Ω	$\pm 0.12 \Omega$
		θ	$\pm 111 \text{ mrad}$	mrad	$\pm 11.2 \text{ mrad}$
1.8 GHz	-40 dBm	Z	$\pm 2.42 \Omega$	Ω	$\pm 0.31 \Omega$
		θ	$\pm 65.8 \text{ mrad}$	mrad	$\pm 8.5 \text{ mrad}$
2.0 GHz	-40 dBm	Z	$\pm 8.56 \Omega$	Ω	$\pm 0.93 \Omega$
		θ	$\pm 97.6 \text{ mrad}$	mrad	$\pm 10.6 \text{ mrad}$
2.4 GHz	-40 dBm	Z	$\pm 19.4 \Omega$	Ω	$\pm 2.11 \Omega$
		θ	$\pm 128 \text{ mrad}$	mrad	$\pm 14.0 \text{ mrad}$
2.6 GHz	-40 dBm	Z	$\pm 5.63 \Omega$	Ω	$\pm 0.75 \Omega$
		θ	$\pm 102 \text{ mrad}$	mrad	$\pm 13.6 \text{ mrad}$
2.8 GHz	-40 dBm	Z	$\pm 2.85 \Omega$	Ω	$\pm 0.31 \Omega$
		θ	$\pm 130 \text{ mrad}$	mrad	$\pm 13.9 \text{ mrad}$

Function Test Record

Agilent Technologies 4287A RF LCR Meter

Mainframe: Serial No.		Test Date	
Test Head: Serial No.		Temperature	°C
Calibration Kit Serial No.		Humidity	%RH
Cable Length:	1 m	Tested by	

DC Resistance Measurement Accuracy Test

Pass

Fail

[]

[]

Low Loss Capacitor Test

Pass

Fail

[]

[]

3 Adjustment

This chapter provides the adjustment procedure for the 4287A RF LCR Meter to ensure that the 4287A is within its specifications.

Safety Considerations

This manual contains NOTES, CAUTIONs, and WARNINGs that must be followed to ensure the safety of the operator and to keep the instrument in a safe and serviceable condition. The Adjustment must be performed by qualified service personnel.

WARNING

Any interruption of the protective ground conductor (inside or outside the equipment) or disconnection of the protective ground terminal can make the can make the instrument dangerous. Intentional interruption of the protective ground system for any reason is prohibited.

Warm-up for Adjustment

Warm-up the 4287A for at least 30 minute before performing any of the following Adjustment procedures to ensure procedures to ensure proper results and correct instrument operation.

Preparation for using the Adjustment Program

To use the Adjustment Program, some preparation is required. This section describes how to its procedure.

Required Controller

The following controller system is required to run the adjustment program.

Windows PC	PC-AT Compatible, RAM:≥64 MBytes, CPU Pentium 200 MHz or faster
OS	Microsoft® Windows NT® (≥4.0), Windows 95®, Windows 98®
Software	Agilent VEE (≥5.0)
GPIB Card	82350A, 82340B, 82341C/D

Installing Agilent VEE for Personal Computer

Install the Agilent VEE into your computer (see the Agilent VEE for Windows®).

Installing Adjustment Program into Your PC

1. Make a copy of the 4287A adjustment program named ADJ4287A.EXE in a directory of the hard disk drive in you PC.
2. Double-click on the filename on the Windows' Explorer to start extracting the self-extracting archive.
3. You will be prompted to enter directory name for installing the program files. Click UNZIP to use default directory (C:\ADJ4287A)
4. Confirm the message that you successfully extract the files and click **OK** and **Close**.

Adjustment
Preparation for using the Adjustment Program

Equipment Setup

Table 1-1 lists the equipment required to perform the Adjustment procedures described in this chapter. Use only calibrated test equipment when adjusting the 4287A.

Performing adjustments requires the system described in this section. The Hardware Setup is shown in Figure 3-1.

Figure 3-1 Adjustment Hardware Setup

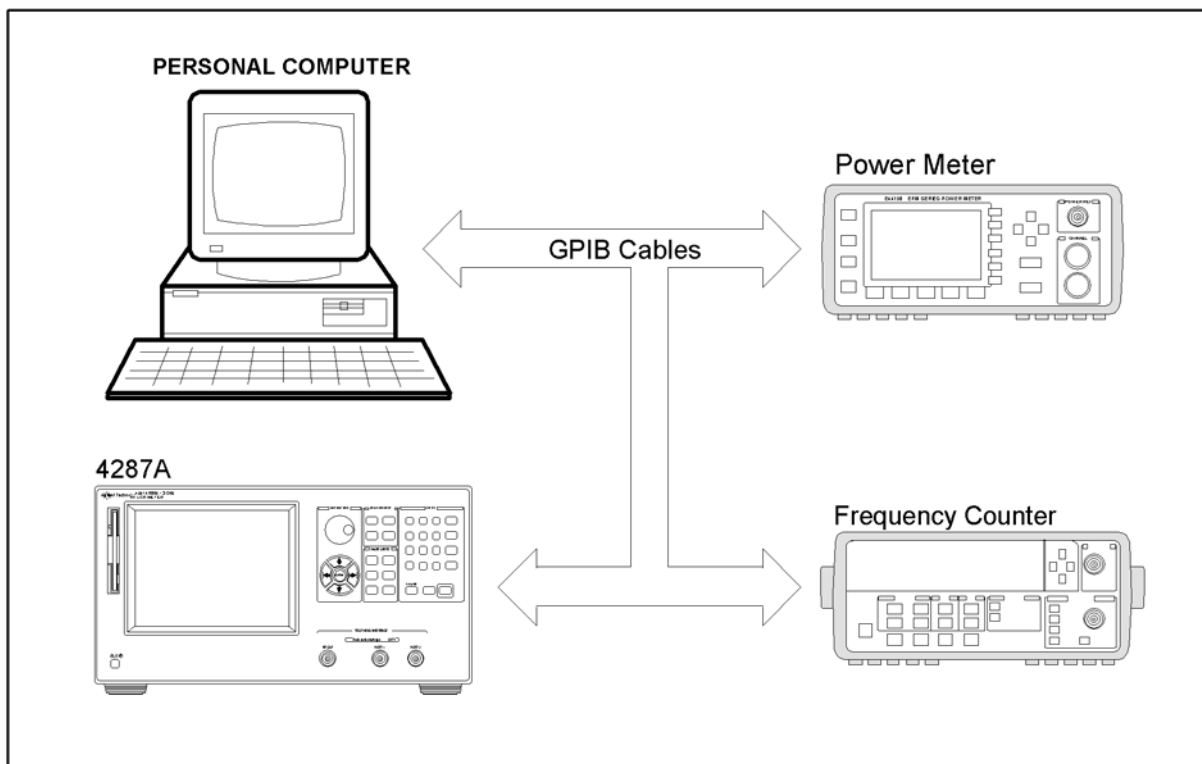

4287ase03005

Order of Adjustment

When performing more than one Adjustment, perform them in the order they appear in this chapter. The procedures are presented in the following order. For example, you need to perform the A4 Local AGC Gain Adjustment and A4 Local Level Adjustment after performing the A3 Local Level Adjustment.

Figure 3-2

Order of Adjustment

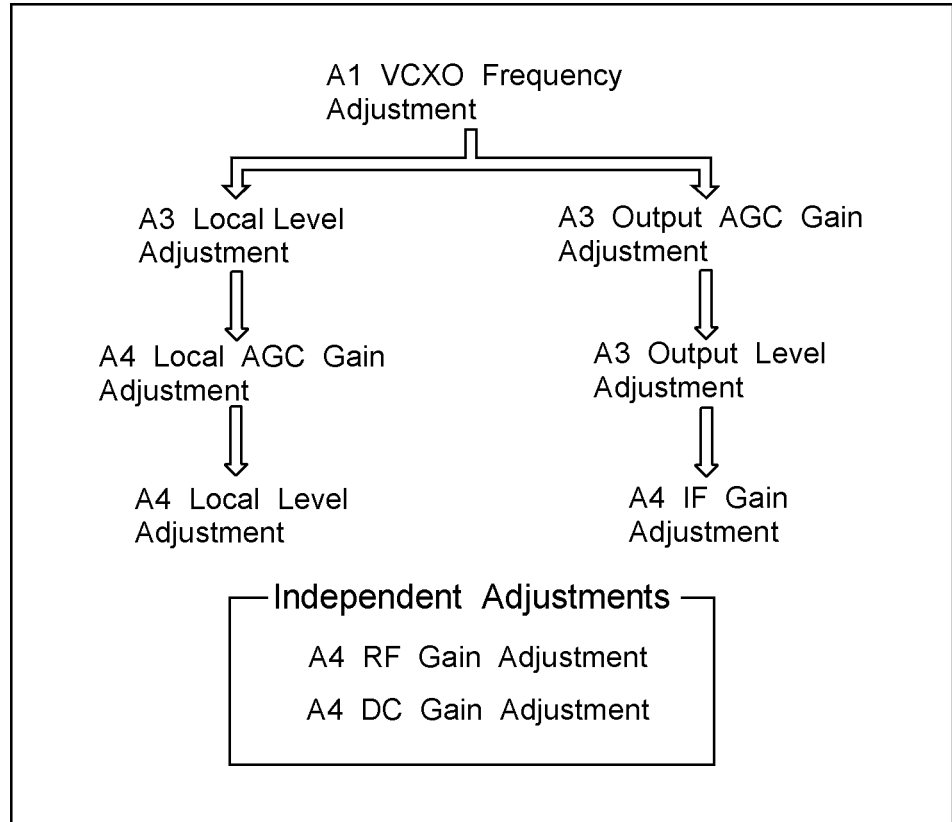

Adjustment
Order of Adjustment

If you replace the following assembly, the adjustment item as shown in Table 3-1 are required. Perform the adjustment in the following order.

Table 3-1

Required Adjustment Item after Replacing Assembly

Replaced Assembly	Required Adjustment								
	A1 VCXO FREQ Adjustment	A3 LOCAL LEVEL Adjustment	A3 AGC GAIN Adjustment	A3 OUTPUT LEVEL Adjustment	A4 AGC GAIN Adjustment	A4 LOCAL LEVEL Adjustment	A4 IF GAIN Adjustment	A4 RF Gain Adjustment	A4 DC Gain Adjustment
A1 REFERENCE OSCILLATOR	1	2	3	4	5	6	7		
A3 SOURCE		1	2	3	4	5	6		
A4 RECEIVER					1	2	3	4	5
A6 TEST HEAD				1			2		

Running the Adjustment Program

Procedure

- Step 1.** Start the Agilent VEE.
- Step 2.** Load the adjustment program file into the Agilent VEE as follows.
 1. Pull down the File menu from the Agilent VEE window and select **Open**.
 2. Select the file C : \ADJ4287A\ADJ4287A . VEE and click **Open**.
- Step 3.** You may be asked to add drivers for the equipment during the program loading. Then, click **OK** and the GPIB address for each equipment. Enter 0 as the address for the equipment which are not used for the adjustment. (See Figure 3-3).

Figure 3-3 Direct I/O configuration

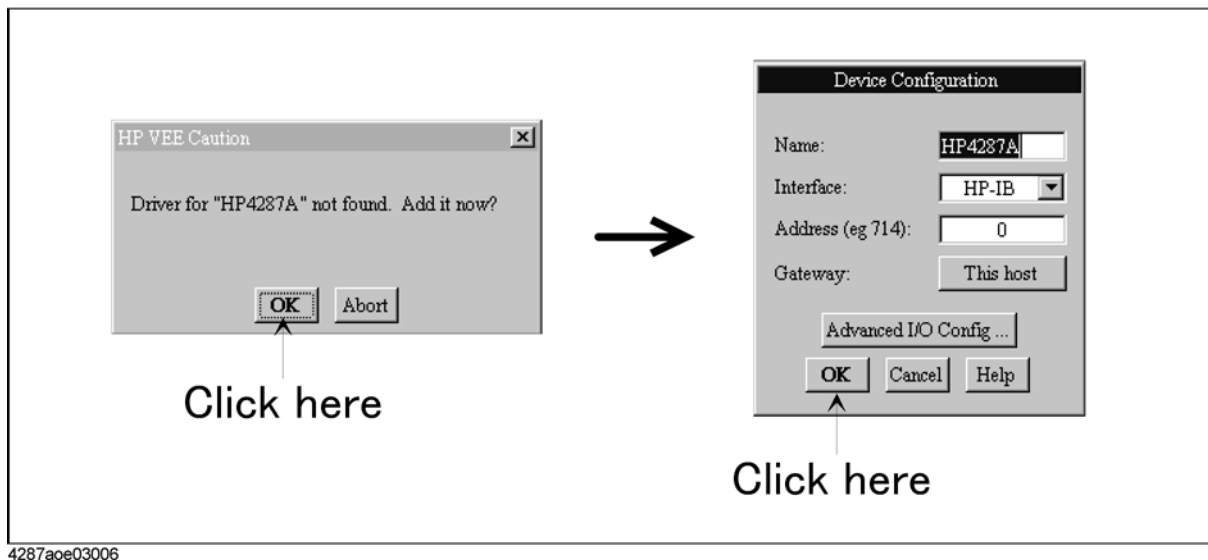

- Step 4.** Click **START** on the Agilent VEE Screen.
- Step 5.** “Setup_menu” box is displayed. Select the model of the equipment and set its GPIB address. Click **OK**, when you complete the settings.

Adjustment

Running the Adjustment Program

Step 6. “4287A Info and Test Conditions” box is displayed as shown in Figure 3-4. Input the 4287A serial number, option and the test conditions. Click **NEXT STEP**, when you complete the settings.

NOTE

The 16195B (Calibration kit 7mm) is not furnished, if the 4287A has an Option 001. In that case, you need to perform the 4287A calibration using the 16195B you have. In the 4287A calibration without Option 001, perform it using the 16195B customer has.

Figure 3-4

4287A Info and test Conditions

4287A Info and Test Conditions

MODEL 4287A

4287A Serial Number and Option

MainFrame JP1KG00112

Test Head JP1KG00112

Calibration Kit JP1KG00112

Options 001 020

Test Conditions

Tested By Agilent Taro

Temperature 25 DEG C

Humidity 47 %

NEXT STEP QUIT PROGRAM

4287ase03009

Step 7. “Select Test Mode” box is displayed. Click **[F1] Adjustment**.

Step 8. “Select - Spot Test -” box is displayed as shown in Figure 3-5. Select one of the adjustment item, and click **NEXT**. Then, the adjustment you selected starts. For details of the each adjustment item, refer to the following pages.

Figure 3-5

Select - Spot Test -

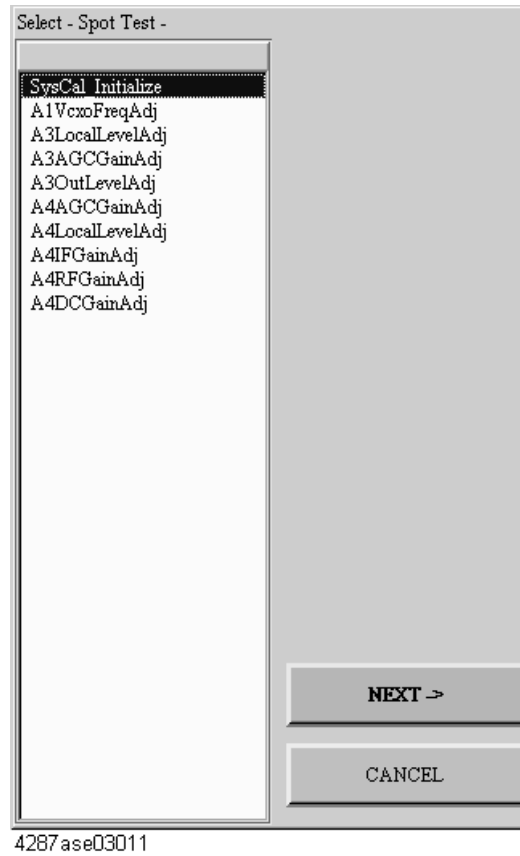

NOTE

When you replace the EEPROM on the A21 Analog Interface board, perform the SvcCal_Initialize first. Immediately after performing it, a message of “Load Default SysCalData” is displayed in the message box. Then, click **Yes**.

A1 VCXO Frequency Adjustment

The purpose of this procedure is to adjust the VCXO on the A1 Reference Oscillator Board.

Required Equipment

Description	Recommended Model
Frequency Counter	5343A, 53181A Opt. 010, 53131A Opt.010 and 030, 53132A Opt.010 and 030, or 53181A Opt.010 and 030
BNC(m)-BNC(m) Cable, 61 cm	p/n 8120-1839

Procedure

- Step 1.** Run the adjustment program.
- Step 2.** Choose the A1VcxoFreqAdj.
- Step 3.** Make sure that nothing is connected to the “Ext Ref In” on the 4287A rear panel.
- Step 4.** Connect the instrument as shown in Figure 3-6

Figure 3-6 A1 VCXO Frequency Adjustment Setup

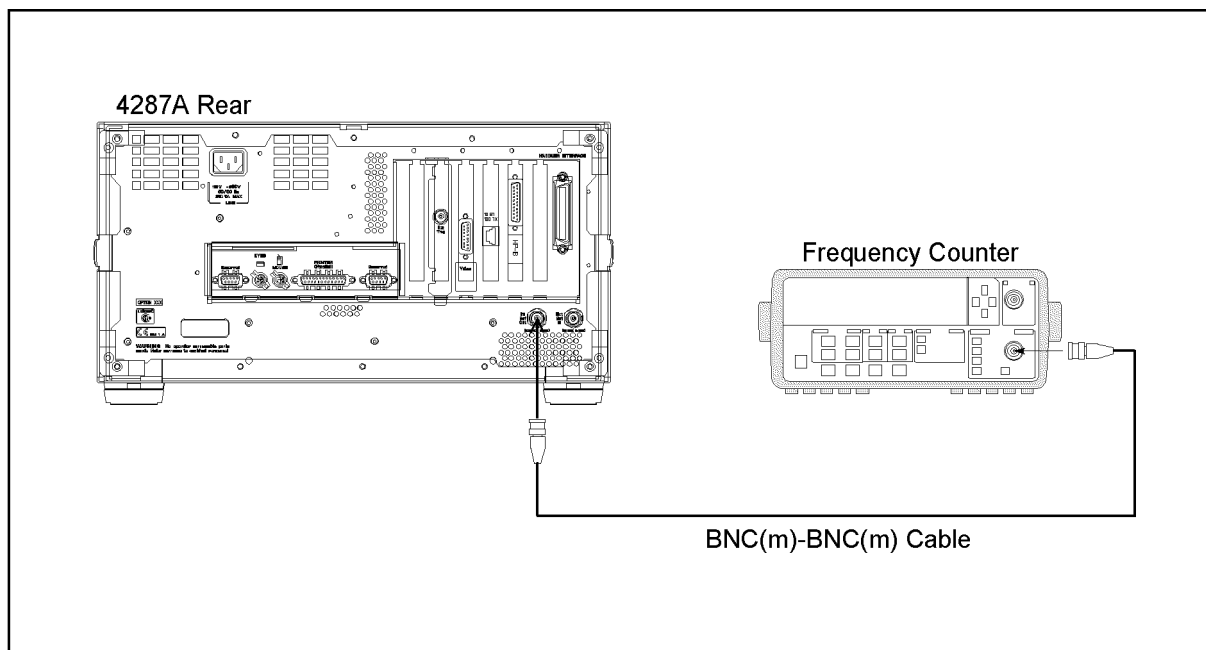

4287ase03001

- Step 5.** Follow the adjustment program instruction to update the correction constant.

A3 Local Level Adjustment

The purpose of this procedure is to adjust the local level on the A3 Source Board.

Required Equipment

Nothing

Procedure

- Step 1.** Run the adjustment program.
- Step 2.** Choose the `A3LocalLevelAdj`.
- Step 3.** Make sure that nothing is connected to the 4287A.
- Step 4.** Follow the adjustment program instruction to update the correction constant.

A3 Output AGC Gain Adjustment

The purpose of this procedure is to adjust the gain of AGC on the A3 Source Board.

Required Equipment

Description	Recommended Model
Calibration Kit	16195B
7mm-N(f) Adapter	11524A

Procedure

- Step 1.** Run the adjustment program.
- Step 2.** Choose the A3AGCGainAdj.
- Step 3.** Connect the instrument as shown in Figure 3-7.

Figure 3-7 A3 AGC Gain Adjustment Setup

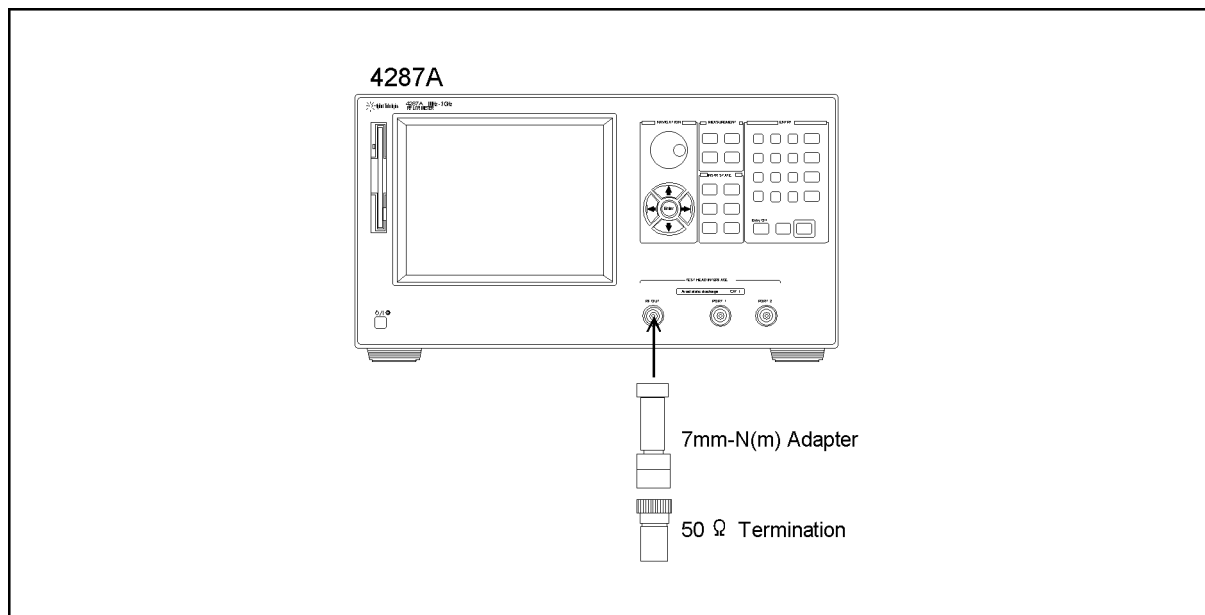

4287ase03007

- Step 4.** Follow the adjustment program instruction to update the correction constant.

A3 Output Level Adjustment

The purpose of this procedure is to adjust the A3 output level and flatness.

Required Equipment

Description	Recommended Model
Power Meter	438A, E4418A/B or E4419A/B
Power Sensor	8482A or E9304A * ¹
Calibration Kit	16195B
Test Fixture Station	p/n 04287-60121
7mm-3.5mm(m) Adapter	p/n 1250-1746
7mm-N(f) Adapter	11524A

*1. The E9304A cannot be used with the 438A.

Procedure

- Step 1.** Run the adjustment program.
- Step 2.** Choose the A3OutLevelAdj.
- Step 3.** Connect the instrument as shown in Figure 3-8.

Figure 3-8 A3 Output Level Adjustment Setup 1

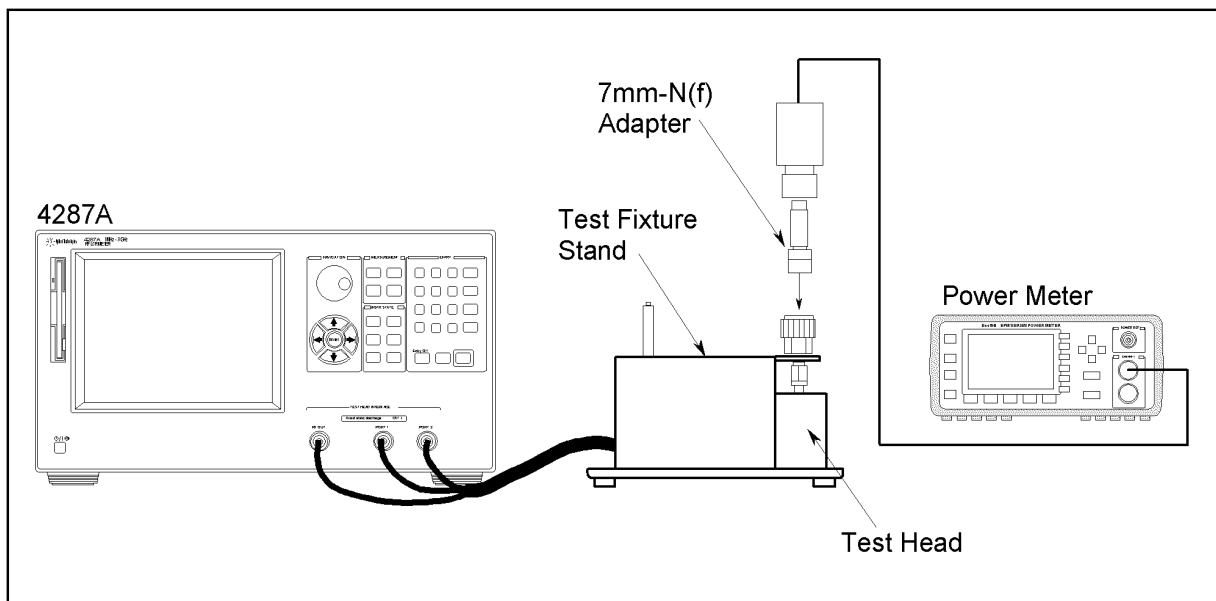

4287ase02002

Adjustment
A3 Output Level Adjustment

Step 4. Click **OK**, then wait till the measurement finish.

Step 5. Disconnect the power sensor and the adapter from the 7mm connector.

Step 6. Connect the instrument as shown in Figure 3-9.

Figure 3-9 **A3 Output Level Adjustment Setup 2**

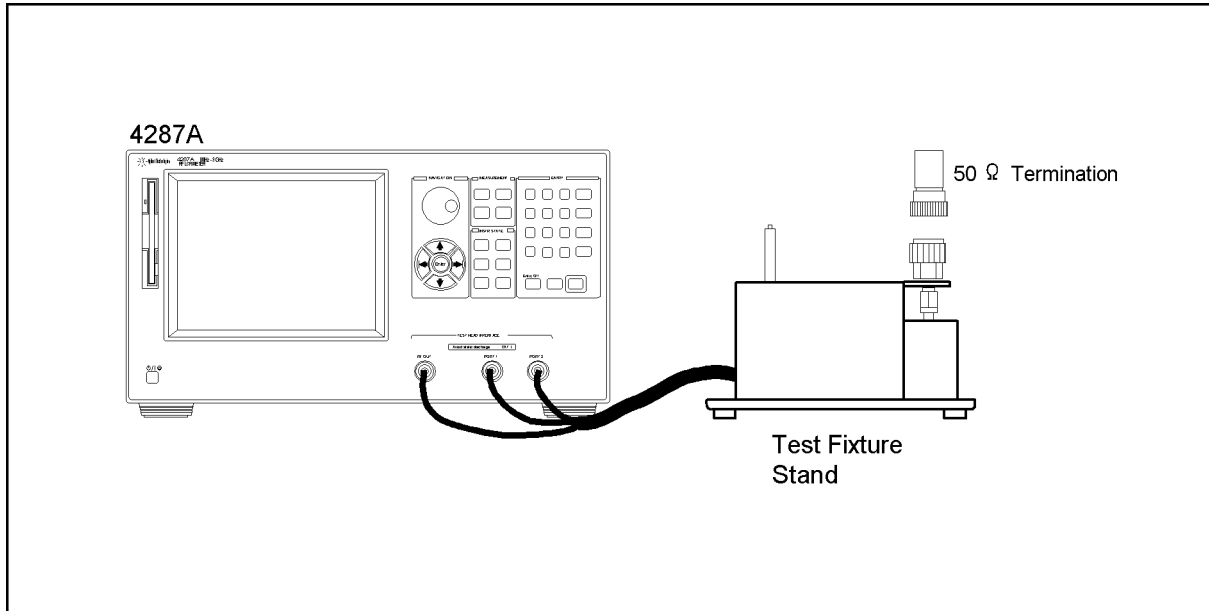

4287ase03003

Step 7. Follow the adjustment program instruction to update the correction constant.

A4 AGC Gain Adjustment

The purpose of this procedure is to adjust the Gain of AGC on the A4 Receiver Board.

Required Equipment

Nothing

Procedure

- Step 1.** Run the adjustment program.
- Step 2.** Choose the A4AGCGainAdj.
- Step 3.** Make sure that nothing is connected to the 4287A.
- Step 4.** Follow the adjustment program instruction to update the correction constant.

A4 Local Level Adjustment

The purpose of this procedure is to adjust the local level in the A4 Receiver Board.

Required Equipment

Nothing

Procedure

- Step 1.** Run the adjustment program.
- Step 2.** Choose the A4LocalLevelAdj.
- Step 3.** Make sure that nothing is connected to the 4287A.
- Step 4.** Follow the adjustment program instruction to update the correction constant.

A4 IF Gain Adjustment

The purpose of this procedure is to adjust the IF Gain in the A4 Receiver Board.

Required Equipment

Description	Recommended Model
Calibration Kit	16195B
Test Fixture Station	p/n 04287-60121
7mm-3.5mm(m) Adapter	p/n 1250-1746

Procedure

- Step 1.** Run the adjustment program.
- Step 2.** Choose the A4IFGainAdj.
- Step 3.** Connect the instrument as shown in Figure 3-10.

Figure 3-10 A4 IF Gain Adjustment Setup

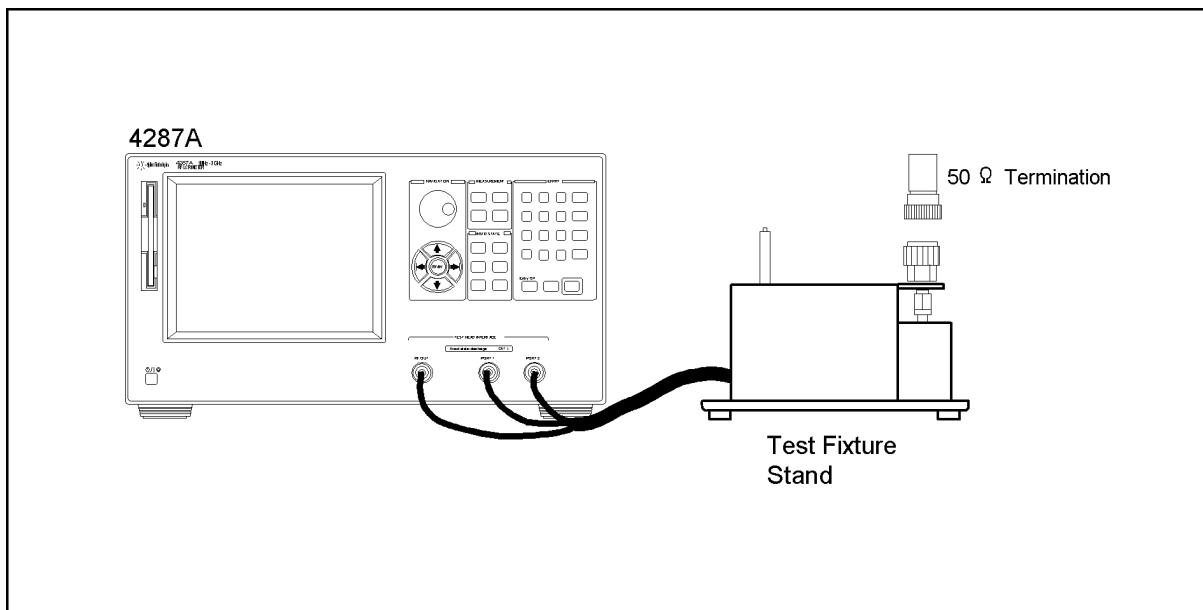

4287ase03003

- Step 4.** Follow the adjustment program instruction to update the correction constant.

A4 RF Gain Adjustment

The purpose of this procedure is to adjust the RF Gain in the A4 Receiver Board.

Required Equipment

Nothing

Procedure

- Step 1.** Run the adjustment program.
- Step 2.** Choose the A4RFGainAdj.
- Step 3.** Make sure that nothing is connected to the 4287A.
- Step 4.** Follow the adjustment program instruction to update the correction constant.

A4 DC Gain Adjustment

The purpose of this procedure is to adjust the DC Gain in the A4 Receiver Board.

Required Equipment

Nothing

Procedure

- Step 1.** Run the adjustment program.
- Step 2.** Choose the A4DCGainAdj.
- Step 3.** Make sure that nothing is connected to the 4287A.
- Step 4.** Follow the adjustment program instruction to update the correction constant.

Adjustment
A4 DC Gain Adjustment

4 Troubleshooting

This chapter provides procedure to isolate the failure assembly in the 4287A RF LCR Meter.

Introduction

-
- WARNING** These servicing instructions are for use by qualified personnel only. To avoid electrical shock, do not perform any servicing unless you are qualified to do so.
-
- WARNING** The opening of covers or removal of parts is likely to expose dangerous voltages. Disconnect the instrument from its power supply.
-
- CAUTION** Many of the assemblies in this instrument are very susceptible to damage from ESD (electrostatic discharge). Perform the following procedures only at a static-safe workstation and wear a grounding strap.
-
- CAUTION** Do NOT operate without following instructions. Programs or files in the instrument may be broken.
-

Service Mode and Instrument Mode

The 4287A has two modes, instrument mode and service mode. Usually the 4287A is in instrument mode, and the 4287A is set to the service mode to isolate the faulty part.

Procedure to Change from Instrument Mode to Service Mode

- Step 1.** Connect a mouse and an external keyboard to the 4287A. Do not connect anything to the LAN interface. Then turn the 4287A on.
- Step 2.** Press the **[System]** key on the 4287A front panel, and press **SERVICE MENU**, **MISC MENU**, **SHUTDOWN AS SERVICE** softkeys. Then Figure 4-1 is displayed.

Figure 4-1 Shutdown Menu



- Step 3.** Type the password “kid” and click **OK**. The 4287A shuts down automatically.
- Step 4.** Press the 4287A power line switch twice to turn the 4287A on. Then Figure 4-2 is displayed.

Figure 4-2 Windows screen after the service mode boot (Example)



NOTE

When the 4287A is in the Service mode, you have to shut down the 4287A by following mouse procedure.

Start - Shut Down... - Shut down - OK

If you ignore above procedure and shut down the 4287A by pressing the power switch, the scan disk run at the next boot.

NOTE

Don't forget to return the mode to the Instrument Mode after the troubleshooting. The procedure to return from the Service Mode to the Instrument Mode is written below.

Procedure to Change from Service Mode to Instrument Mode

- Step 1.** Connect a mouse and an external keyboard to the 4287A. Do not connect anything to LAN interface. Then turn the 4287A on.
- Step 2.** After the Windows98 screen is displayed, double-click the "4287A RF LCR Meter" icon.
- Step 3.** Press **[System]** key on the 4287A front panel, and press **SERVICE MENU, MISC MENU, SHUTDOWN AS INSTR** softkeys.
- Step 4.** Type password "kid" and click **OK**. The 4287A shutdown automatically.
- Step 5.** Press the 4287A power line switch twice to turn the 4287A on.

To Troubleshoot the Instrument

The primary procedural tool in this section is the flowchart. The flowchart contains entire troubleshooting path from a failed instrument to a working one, and will direct you in an orderly manner through the possible failure symptoms. Reference letters on the flowcharts point to procedural steps that explain the brief instructions in the chart.

Primary Trouble Isolation

The action in the Primary Trouble Isolation are done without disassembling the 4287A.

Step 1. Perform power-up

About few minutes after the 4287A is turned on the measurement view is displayed on the screen. The display on the screen should be similar to the Figure 4-15, “G: Measurement View,” on page 112.

Step 2. Check the display

If there is no display on the LCD after the 4287A is turned on, go to “No Display Troubleshooting” on page 101. If the 4287A stops in booting process in spite of the anything is displayed on the LCD, go to “Booting Process Troubleshooting (for serial prefix JP1KG, JP2KG, and MY432)” on page 105 or “Booting Process Troubleshooting (for serial prefix MY433 and later)” on page 113. The power on self test is performed once automatically after the 4287A measurement view is displayed. If power on self test fails, go to “Troubleshooting Using Internal Test” on page 117.

Step 3. System Works; Do performance test using procedures in “Performance Test” on page 32.

If you find the 4287A’s function without measurement part doesn’t work correctly, go to “Function Depend Troubleshooting” on page 119. If you find the measurement data is wrong or the 4287A performance test fails, go to “Analog Section Troubleshooting” on page 132.

Figure 4-3

Primary Trouble Isolation Flowchart

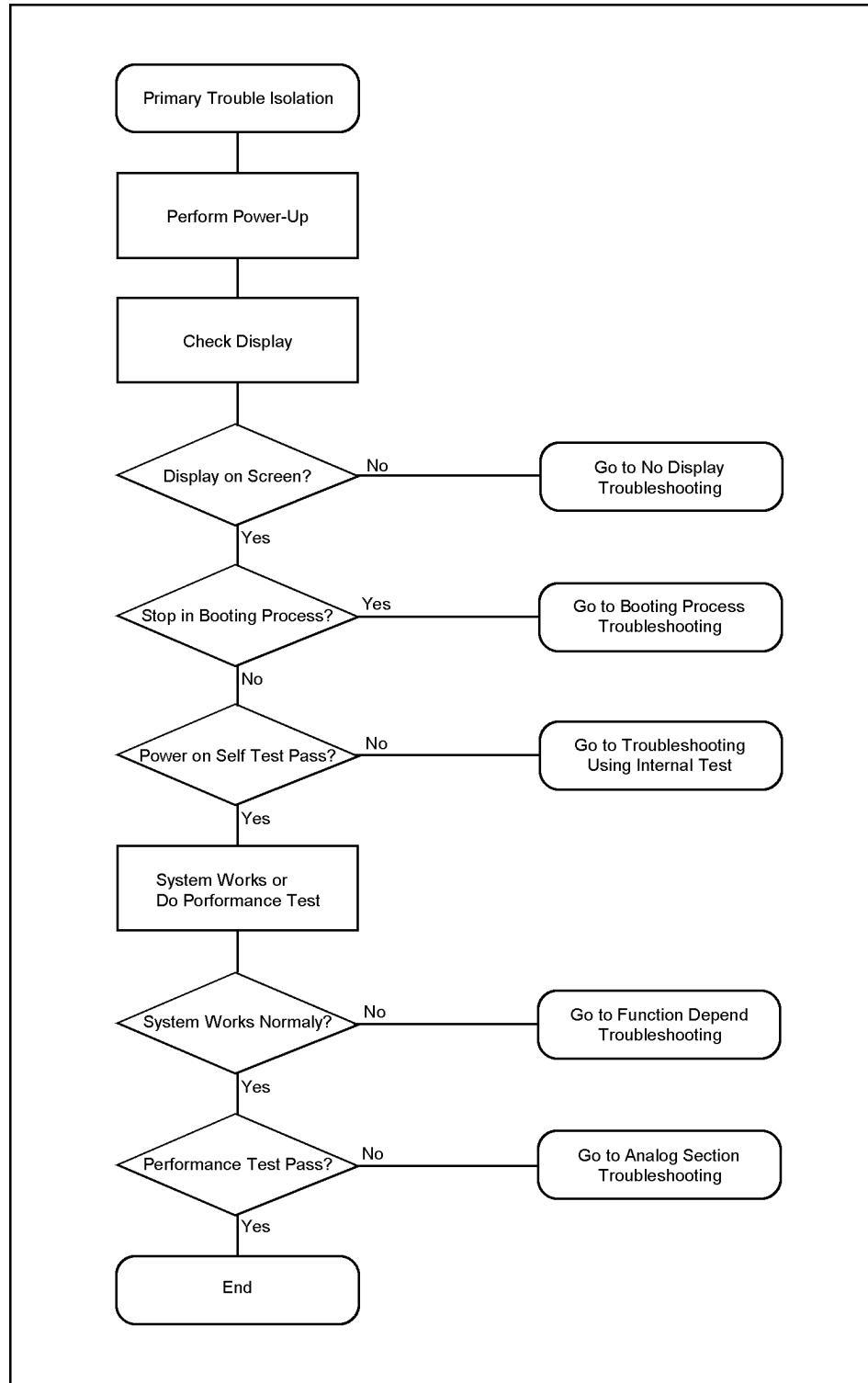

4287ase04036

No Display Troubleshooting

If you encounter problems which there is no display on the 4287A LCD, isolate the failure part in accordance with the following procedure.

Connect the external keyboard to the 4287A rear, and turn the 4287A on. And, start the trouble isolation.

Figure 4-4

No Display Trouble Isolation

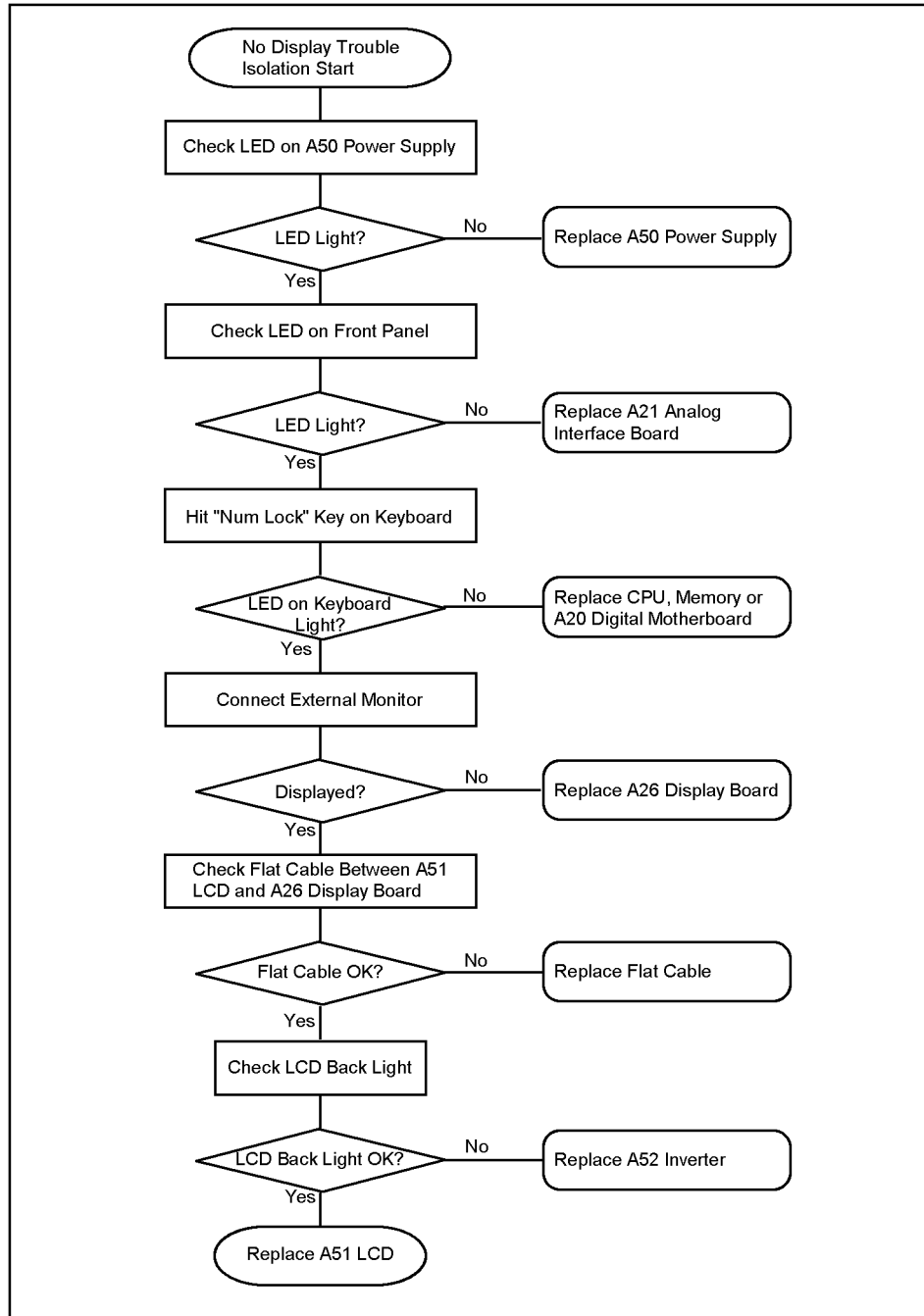

4287ase04012

Step 1. Check LED on A50 Power Supply

From the 4287A rear, check the LED inside of the lattice of the rear panel as shown in Figure 4-5. If the LED doesn't light, the A50 Power Supply assembly is failure.

Figure 4-5

LED on the A50 Power Supply

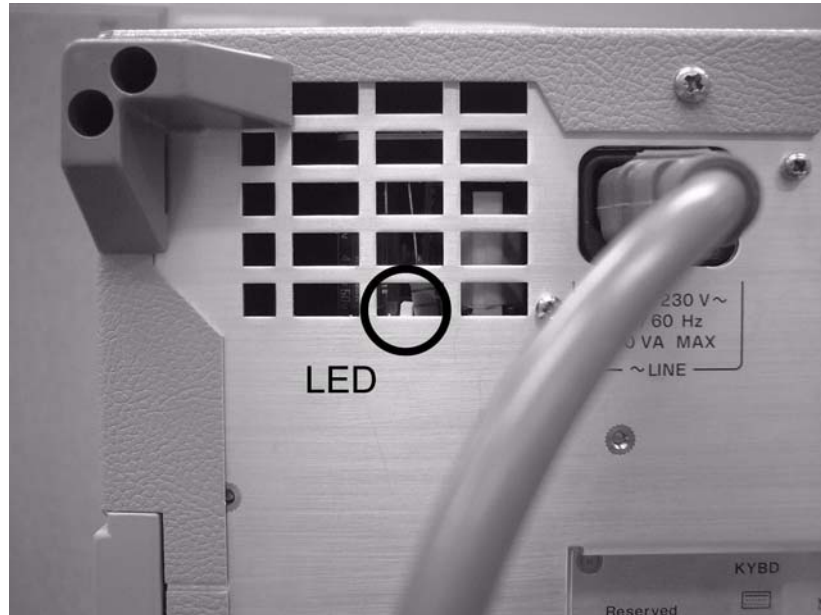

Step 2. Check power LED

If the power LED doesn't light and the fans inside of the 4287A doesn't run, problem seems in the A21 Analog Interface board or the flat cable between the A21 and the A22 Front Panel Keyboard.

If power shutdown occurs immediately after the power LED lights, there is a possibility that the fan stops. The 4287A has three fans inside. There is one CPU fan on the A20 Digital Motherboard. There are two system fans which are attached on the frame. A power shutdown occurs the moment the system fans stops. In this case, remove the 4287A outer cover and make sure whether the fans run or stop.

Troubleshooting
No Display Troubleshooting

Step 3. Check LED on the **[Num Lock]** key

Hit **[Num Lock]** key which is on the external keyboard as shown in the Figure 4-6. If a LED doesn't light, problem seems in the CPU, DIMM64MB, or A20 Digital Motherboard.

Figure 4-6 LED of the **[Num Lock]** key



NOTE

Make sure of the followings before replacing the CPU, DIMM64MB, or A20.

- Whether CPU, DIMM64MB, and BIOS ROM on the A20 are connection good or not.
 - Whether the jumpers setting on the A20 are correct or not as described in “Configure the Motherboard” on page 137.
 - Whether BIOS options are correct or not as described in “To Confirm or Set the BIOS Options” on page 139.
-

Step 4. Checking with the external monitor

Connect an additional VGA monitor to the VIDEO output on the 4287A rear panel.

- If something is displayed on the external monitor, problem is around the LCD.
- If nothing is displayed even on the external monitor, problem seems in A26 Display board or around the A20 Digital Motherboard.

Step 5. Check Flat Cable

Check a flat cable between A51 LCD and A26 Display board.

Step 6. Check around the Back Light

Check A52 Inverter board, cable between A52 and A26 Display board, and cables between A51 LCD and A52.

Booting Process Troubleshooting (for serial prefix JP1KG, JP2KG, and MY432)

Figure 4-7

Booting Process

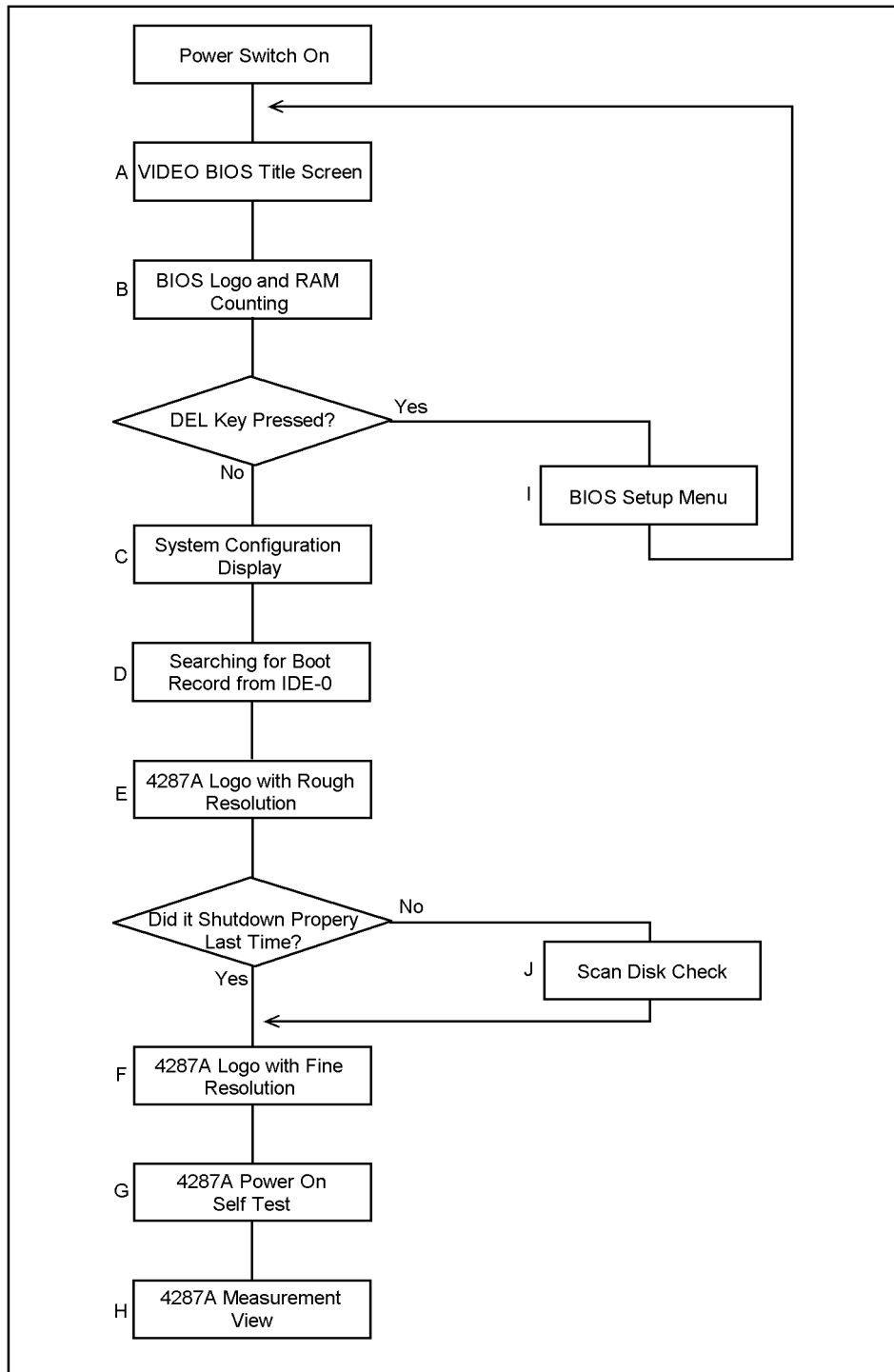

4287ase04031

Step 1. Video BIOS Boot

Video BIOS title screen shown in Figure 4-8 is displayed first, when the 4287A turned on. If the Video BIOS title screen doesn't displayed, go to "No Display Troubleshooting" on page 101.

Figure 4-8

A: Video BIOS Title Screen

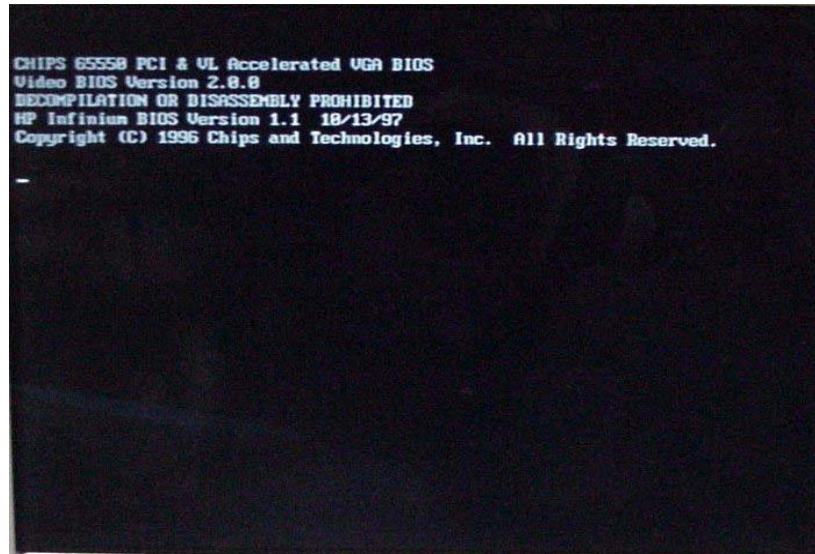

Step 2. BIOS, RAM Counting

BIOS logo screen shown in Figure 4-9 describes the BIOS name, model number of the Digital Motherboard, CPU type and RAM size on the Digital Motherboard, and type of the Mass Storage.

If the message is displayed, you can assume that A20 Digital Motherboard, CPU and DIMM64MB are functioning correctly.

If the 4287A stops during checking RAM, you can assume problem is in the A20, or DIMM64MB.

For the 4287A with opt 010, A27 Mass Storage is a HDD (Hard Disk Drive). For the 4287A with opt 011, A27 is a Flash Disk.

NOTE

Hit **[Delete]** key on the external keyboard during the above screen is displayed, if you want run the BIOS setup utility.

It is able to be the followings using the BIOS setup utility. For details of the BIOS options the 4287A is specified, refer to "To Confirm or Set the BIOS Options" on page 139.

- to set the system date and time
- to change the first boot device (if you want to boot from floppy disk, it is necessary to change it.)
- to confirm the BIOS options
- to confirm the configuration of the mass storage (hard disk or flash disk) after detecting

the new mass storage

Figure 4-9

B: BIOS Logo and RAM Counting

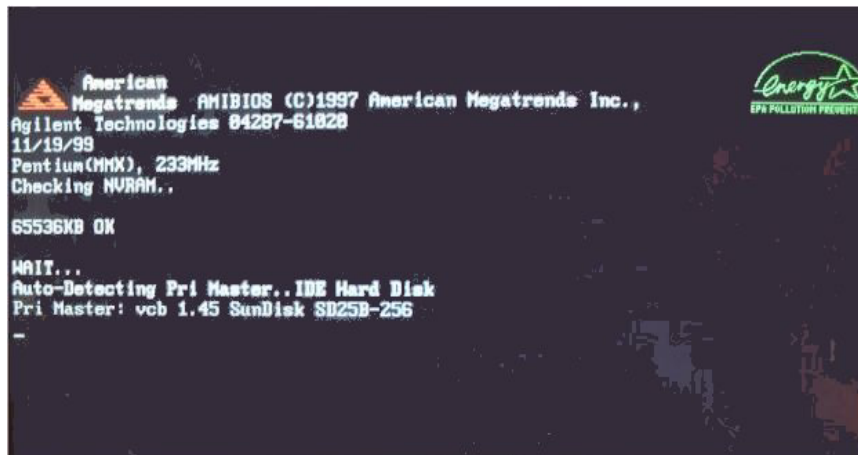

Step 3. System Configuration

The BIOS checks the 4287A configuration and displays it shown in as Figure 4-10. Three PCI boards, A21, A25, and A26 can be confirmed like below.

- “PCI Slot 1 : Ethernet” is A25 LAN board
- “PCI Slot 2 : VGA” is A26 Display board
- “PCI Slot 3 : Unknown Device” is A21 Analog Interface board

If the BIOS couldn't detect above boards caused by hardware problem or poor connection, nothing is displayed there. In addition, the BIOS can not check the operation of the above boards. When nothing is displayed there, doubt first whether a PCI slot connection is poor or not.

But A23 Handler Interface and A24 GPIB board can't be confirmed because they are on the ISA slots.

Figure 4-10

C: System Configuration

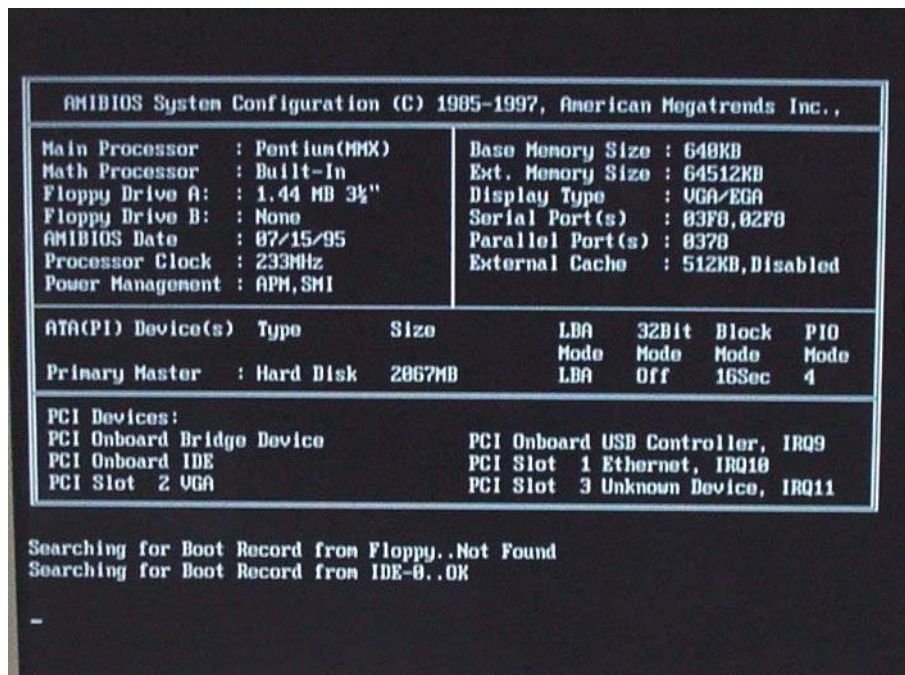

Step 4. Searching for Boot Record

A message of “Searching for Boot Record from IDE-0..OK” shown in Figure 4-11 is displayed after system configuration is displayed when the 4287A starts to boot from the A27 Mass Storage (IDE-0) without problem. However, a message of “Drive Not Ready” shown in Figure 4-11 is displayed when the 4287A could not boot from it. In this case, the 4287A may have a problem around the A27.

Figure 4-11

D: message of Hard Disk not ready

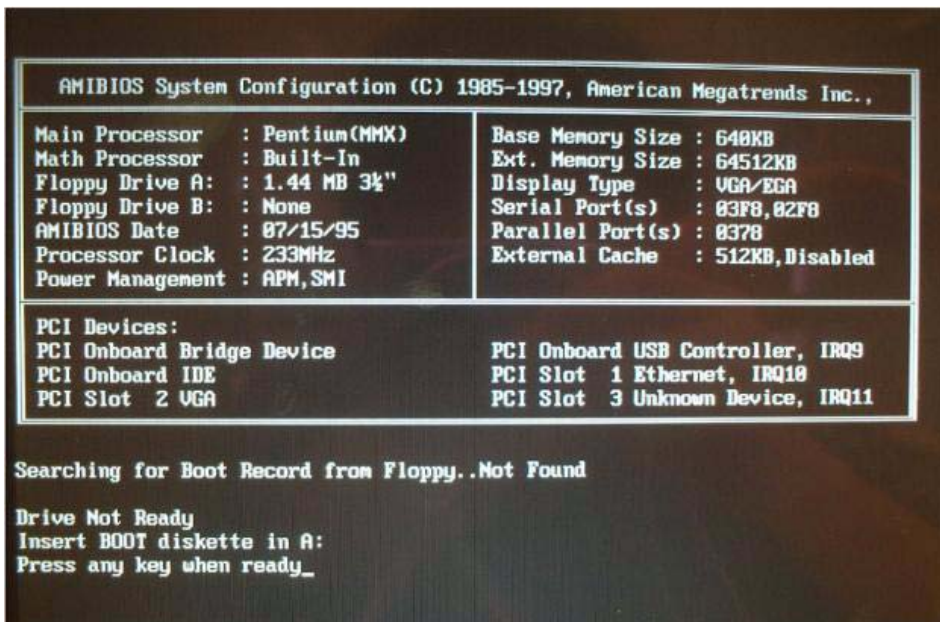

Booting Process Troubleshooting (for serial prefix JP1KG, JP2KG, and MY432)

You can check whether the A27 gives hardware problem or not using BIOS setup utility as shown in Figure 4-12. For details of how to run the BIOS setup utility, refer to “Run the BIOS setup utility” on page 139.

Move the cursor to “Auto-Detect Hard Disks” using [↑], [↓] keys and hit [Enter] key at the BIOS setup utility main menu. Then Figure 4-12 is displayed.

Figure 4-12 Auto-Detect Hard Disks page

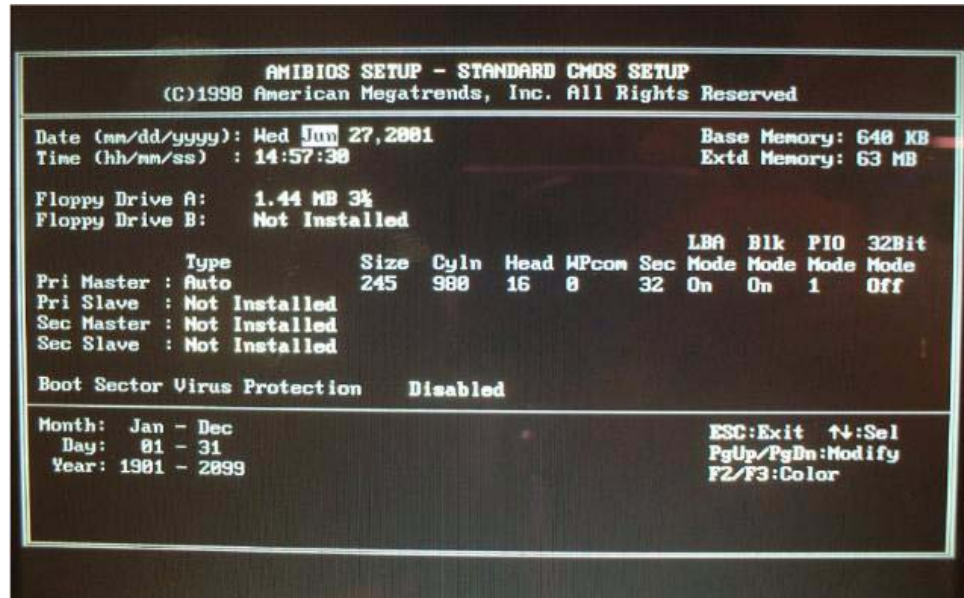

The 4287A has an A27 (hard disk drive or flash disk drive) which is connected to the IDE1 connector on the A20 Digital Motherboard. The disk size, cyln and so on are displayed as shown in the Figure 4-12 as soon as the mass storage is detected. If the mass storage is not detected, “Not Installed” is displayed on “Pri Master” right. In this case, check the flat cables first which are connected with the A27 and the A20 via the A26 Display board. If the flat cables are ok, replace the A27.

Troubleshooting

Booting Process Troubleshooting (for serial prefix JP1KG, JP2KG, and MY432)

Step 5. 4287A Logo

Files of the 4287A logos are in A27 Mass Storage. If the logos are displayed, the A27 works.

NOTE

If the 4287A was turned off without shutdown process, scan disk check run after 4287A logo with rough resolution is displayed. If serious trouble is found in the scan disk, reinstall the operating system. For details of the system installation, refer to Appendix B, “System Installation for A27 Mass Storage,” on page 241. And if the operating system still doesn’t boot properly after reinstallation, A27 has to be replaced physically.

And, you encounter the following problems, try to reinstall the operating system before replacing the A27.

- “xxx file is missing” is displayed on the DOS screen.
- The 4287A logo screen is not displayed after “Searching for Boot Record from IDE-0 .. OK” is displayed.
- Windows always boots with Safe Mode.

NOTE

To use the 4287A functions is necessary to install its device drivers to the operating system. The Agilent factory installs the necessary device drivers to the 4287A (operating system) and ship it. The operating system checks the necessary device driver. When the operating system doesn’t detect it, the message box is displayed. You need to prepare the device driver and to install it, if you experience the above situation.

Figure 4-13

E: 4287A Logo with rough resolution

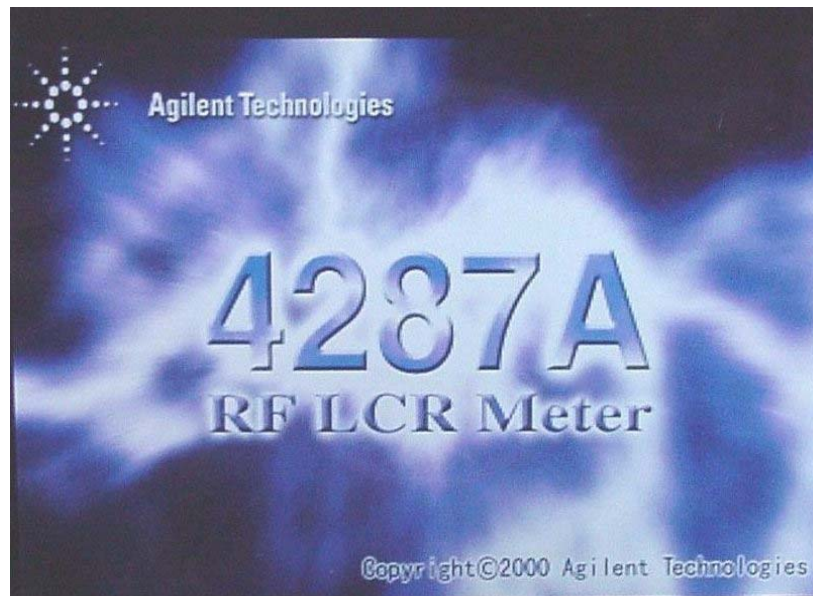

During the logo with fine resolution is displayed, an operating system (Windows 98) is loaded from A27 to DIMM64MB.

Figure 4-14

F: 4287A Logo with fine resolution



Step 6. Power On Self Test

An initializing and the power on self test is executed once automatically before the measurement starts. For details, refer to “Troubleshooting Using Internal Test” on page 117. In addition, a message of the “Internal Test In Progress...” is displayed during the power on self test in progress. If an hang-up occurs during the power on self test, problem seems in analog block such as A1 Reference OSC, A3 Source, or A4 Receiver.

Step 7. Measurement View (Power On Display Default)

The measurement view as shown in Figure 4-15 is displayed after the 4287A firmware is loaded without problem.

Figure 4-15

G: Measurement View

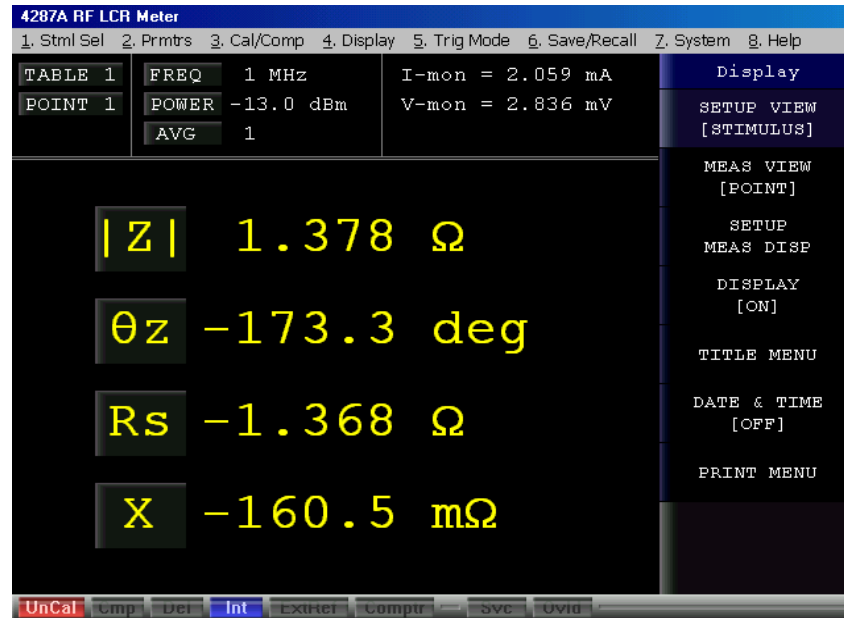

Booting Process Troubleshooting (for serial prefix MY433 and later)

Figure 4-16 represents the booting process flow in the 4287A. If the 4287A stops in the booting process, troubleshoot using the following step-by-step procedure.

Figure 4-16

Booting process flowchart

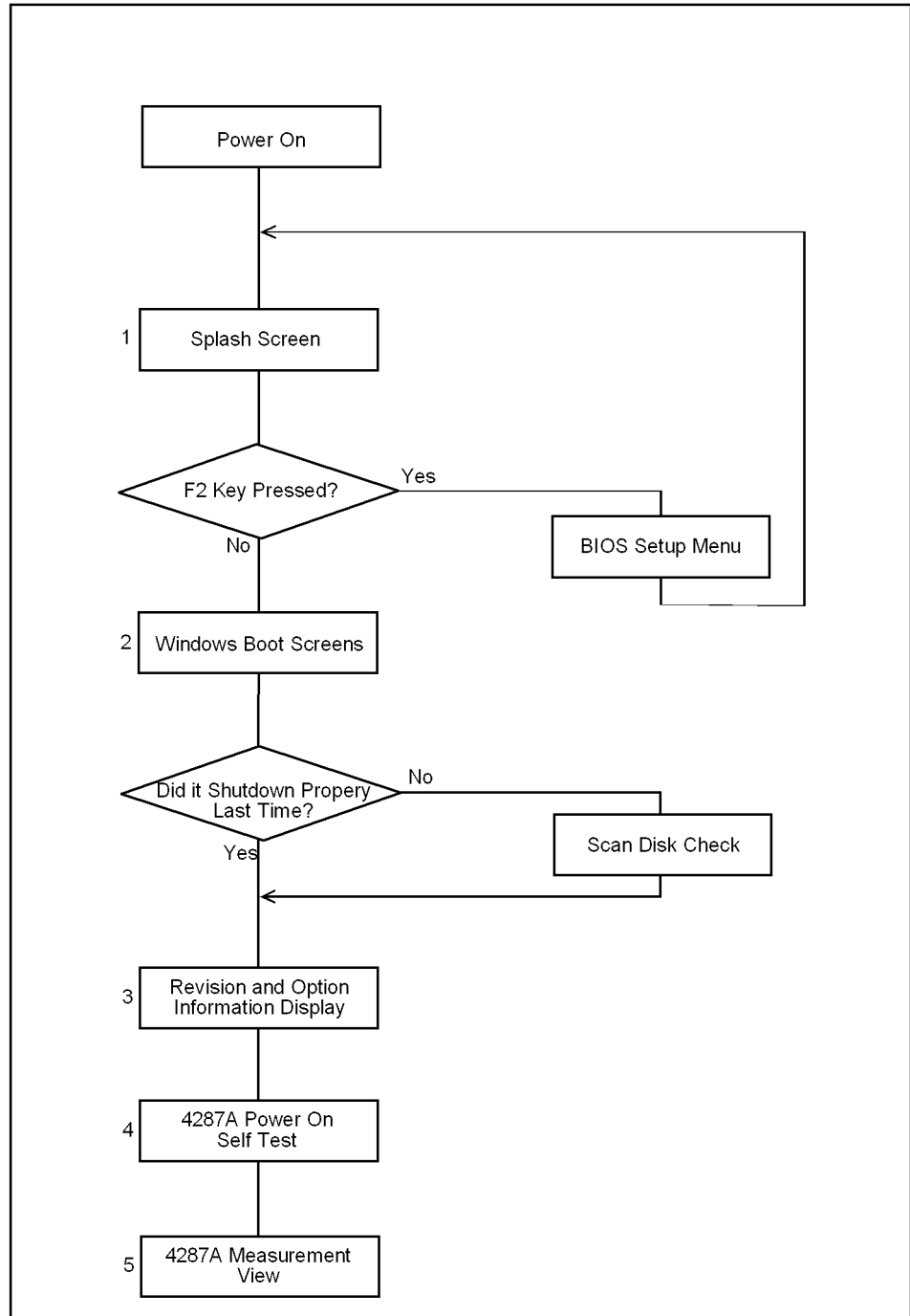

4287ase_005

Step 1. Splash Screen

The splash screen is displayed with Agilent logo as shown in Figure 4-17.

If the splash screen is displayed, you can assume that the A20 digital motherboard is functioning correctly.

NOTE

While the splash screen is displayed, if you want to run the BIOS setup utility, push F2 key as soon as in the screen.

Figure 4-17

Splash Screen



Step 2. Windows boot screens

The Windows boot screens are displayed. The Windows boot screens consists of two screens. Each screen is displayed in the order as shown in Figure 4-17. If the Windows boot screens are displayed, it is assumed that the A27 HDD works. While the Window screens are displayed, Windows operating system is starting up.

Figure 4-18

Windows boot screens

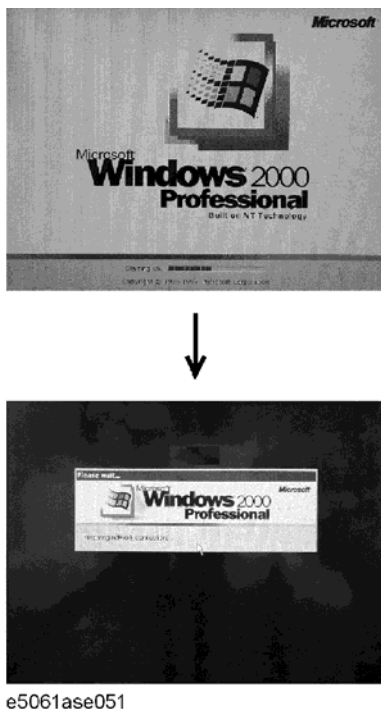

If you encounter the following problems, try to reinstall the operating system before replacing the A27.

- "xxx file is missing" is displayed on DOS screen.
- The Window boot screen is not displayed after the splash screen is displayed.
- Windows always boots up with Safe Mode.

NOTE

If the 4287A was turned off without shutdown process, Microsoft Scandisk runs while the windows boot screens are displayed. If a serious problem is found in the scandisk, reinstall the operating system. For details of the operating system installation, refer to Appendix B, "System Installation for A27 Mass Storage," on page 241. If the operating system still doesn't boot up properly after reinstallation, replace the A27.

NOTE

The operating system automatically checks the device drivers, which are necessary to use the 4287A functions and are installed in the system before the 4287A is shipped from Agilent factory. If the operating system doesn't detect them, a message box is displayed. In this case, install the device driver.

Step 3. Power On Self Test

An initializing and the power on self test is executed once automatically before the measurement starts. For details, refer to "Troubleshooting Using Internal Test" on page 117. In addition, a message of the "Internal Test In Progress..." is displayed during the power on self test in progress. If an hang-up occurs during the power on self test, problem seems in analog block such as A1 Reference OSC, A3 Source, or A4 Receiver.

Step 4. Measurement view

The measurement view as shown in Figure 4-19 is displayed after the system initialization is completed without problem.

Figure 4-19

Measurement view

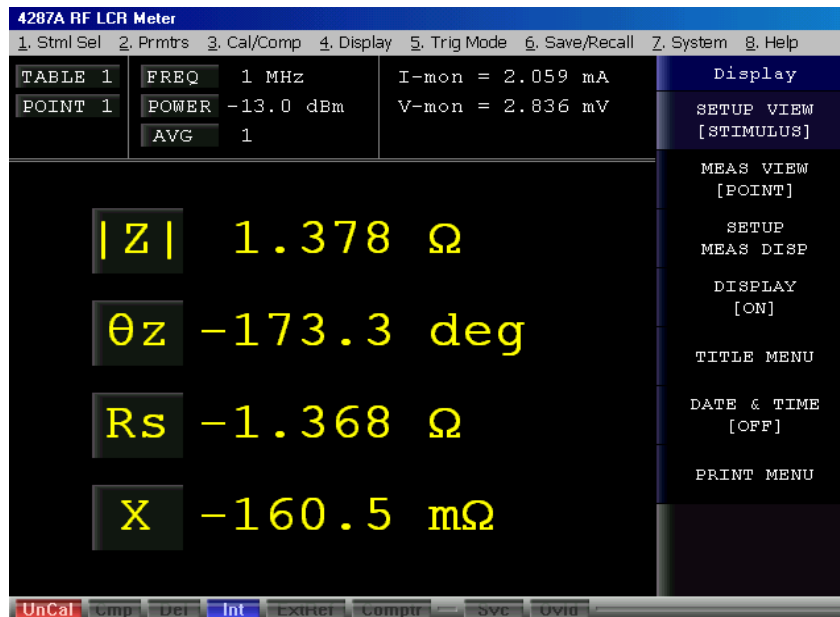

Troubleshooting Using Internal Test

Power On Self Test

The 4287A performs the power on self test once after the 4287A is turned on. When the failure part is detected in the 4287A, a message of the “Power on test failed” is displayed. The content of the power on self test is same as the internal test.

PLL unlock

When phase lock loop is not locked in the 4287A, not “Power on test failed” but “PLL unlock” is displayed.

- If you entered the external reference signal, check to see if it is correct. If you entered the correct signal or you don't entered it, there is a possibility to need repair and/or adjustment.
- When the 4287A is turned on from cold, “PLL unlock” is displayed during few time very occasionally because warm-up time is not enough. If “PLL unlock” is displayed continuously after warm-up, there is a possibility to need repair and/or adjustment. There is a possibility that A1 Reference OSC or A3 Source gives problem.

To Execute Internal Test

If the “Power on test failed” is displayed after the 4287A is turned on, you should perform the internal test to isolate the faulty assembly. You can execute the internal test by following procedure.

Step 1. Perform the internal test in service function by following front panel procedure.

[Alt] - [7] - [7] - [1]

Step 2. Wait until the test result, PASS or FAIL, is displayed. hit **[Enter]** key on the front panel, then internal test dialog box is closed.

Contents of the Internal Test

When the internal test fails, replace the faulty assembly as shown in Table 4-1. The contents of the internal test is as follows;

Table 4-1 Troubleshooting Information for Internal Test Failure

Test Name	Test Point	A1 Ref OSC	A3 Source	A4 Receiver	A6 Test Head
A1_V_P9V	+9V on A1	†††			
A1_V_N9V	-9V on A1	†††			
A1_V_P5V_RF1	+5V for RF1 on A1	†††			
A1_V_P5V_RF2	+5V for RF2 on A1	†††			
A1_V_P5V	+5V on A1	†††			
A3_V_P5V_PLL	+5V for PLL on A3		†††		
A3_V_P10V	+10V on A3		†††		
A3_V_N5V	-5V on A3		†††		
A3_V_N10V_PLL	-10V on A3		†††		
A3_V_OUT_DET	Detect Level of RFOUT AGC on A3		†††		
A3_V_LOCAL_DET	Detect Level of Local AGC on A3		†††		
A4_V_P10_5V	+10.5V on A4			†††	
A4_V_P5V	+5V on A4			†††	
A4_V_P8VA	+8V for CH1 on A4			†††	
A4_V_P8VB	+8V for CH2 on A4			†††	
A4_V_N10_5V	-10.5V on A4			†††	
A4_V_N5V	-5V on A4			†††	
A4_V_LO_DET	Detect Level of Local AGC on A4		††	†††	

†††: Most suspicious assembly

††: Suspicious assembly

Function Depend Troubleshooting

Functions

The 4287A has the following typical functions.

- The hardkeys and knob located on the front panel are divided 4 blocks labeled “Navigation block”, “Measurement block”, “Instrument state block”, and “Entry block” respectively. Some of the front panel keys control the 4287A functions directly. Refer to “To check the Front Panel” on page 123, if you want to check the front panel.
- Almost all the information required for the measurement value, setup state, result data processing, menu bar, softkey label and others is indicated on the color LCD display. An 8.4-inch TFT display is used. Refer to “To check the LCD and Back Light” on page 123, if you want to check the LCD.
- Use of the external keyboard ensures effective entry of the numerical value and character string which is connected to the 4287A rear panel. Refer to “To check the External Keyboard” on page 124, if you want to check the external keyboard.
- Use of the mouse allow you to freely move the pointer on the 4287A LCD display, and effective perform a great variety setups which is connected to the 4287A rear panel. Refer to “To check the Mouse” on page 124, if you want to check the mouse.
- The floppy disk drive is used to save the 4287A setup state and measurement data in the floppy disk and to call them up. It is compatible with a 3.5-inch, 720KB or 1.44MB, DOS format floppy disk. Refer to “To check the FDD” on page 124, if you want to check the FDD.
- The external color monitor is available to display the same information as the 4287A LCD. Refer to “To check the VGA Display Output” on page 125, if you want to check the VGA Display Output.
- The external trigger input terminal allows you to enter the trigger signal to command execution of measurement. Refer to “To check the External Trigger Input” on page 125, if you want to check the external trigger input.
- You can use the LAN port to connect the 4287A to the LAN. Refer to “To check the LAN (for serial prefix JP1KG, JP2KG, and MY432)” on page 125, if you want to check the LAN.
- The handler interface is used to exchange data with the automatic equipment (handler). Refer to “To check the Handler Interface” on page 130, if you want to check the handler interface.
- It is available to build an automatic measurement by connecting the external controller and other equipment through GPIB connector. Refer to “To check the GPIB” on page 131, if you want to check the GPIB.

To check the Device Driver (for serial prefix JP1KG, JP2KG, and MY432)

Make sure first whether the 4287A device drivers are installed properly or not by following procedure, if you experience the 4287A function doesn't work.

- Step 1.** Boot the 4287A with service mode as described in "Procedure to Change from Instrument Mode to Service Mode" on page 97. Then windows desktop screen is displayed.
- Step 2.** Right mouse click "My Computer" icon, and click "Properties". Then System Properties dialog box is displayed.
- Step 3.** Click **Device Manager** tag. The operating system detects all the necessary device driver, Figure 4-20 is displayed. However, if it doesn't detect the necessary device driver, a yellow back grounded "!" icon as shown in Figure 4-21 is displayed. The Figure 4-21 shows the example of the operating system doesn't detect the LAN board (3Com EtherLink 10/100 PCI TX NIC [3C905B-TX]) properly. So, the device of the LAN board with the yellow back grounded "!" icon is displayed.

Figure 4-20

View Installed Device Drivers

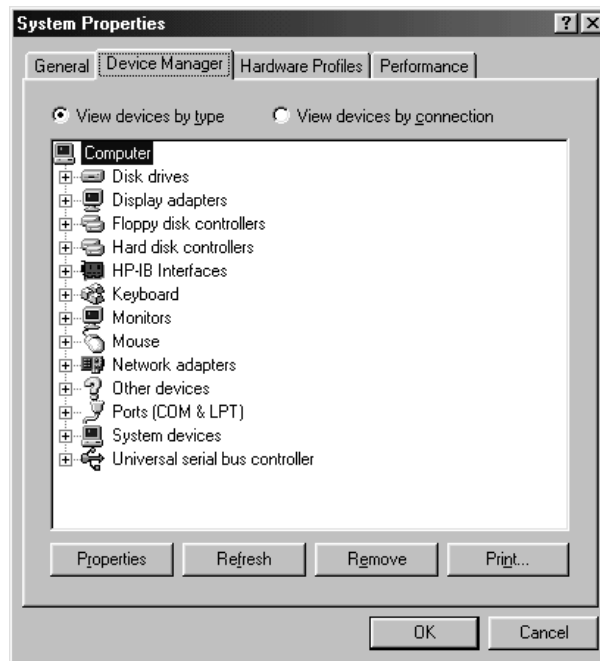
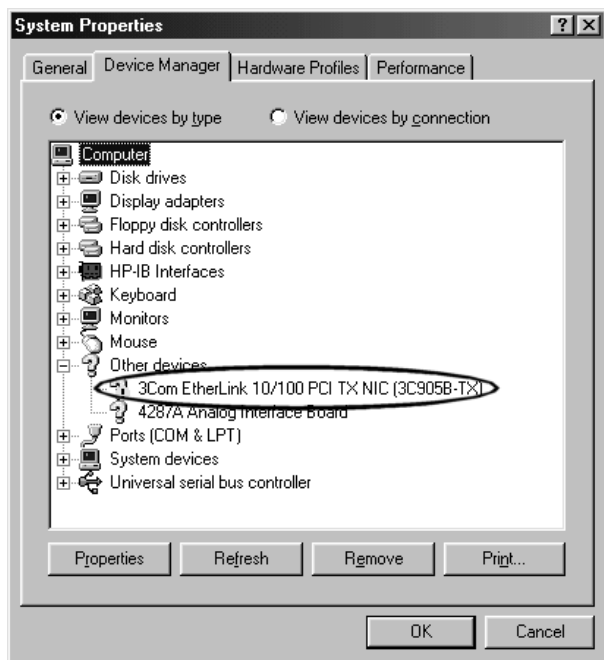

Figure 4-21 Example of no device driver file in system



To check the Device Driver (for serial prefix MY433 and later)

Make sure first whether the 4287A device drivers are installed properly or not by the following procedure, if you experience the 4287A function doesn't work.

- Step 1.** Exit from the 4287A Measurement Display as shown in "Service Mode and Instrument Mode" on page 97. Then windows desktop screen is displayed.
- Step 2.** Click "My Computer" with the right button and select "Properties" as shown in Figure 4-22. Then, the System Properties(Figure 4-23) will appear.

Figure 4-22 Opening System Property Window

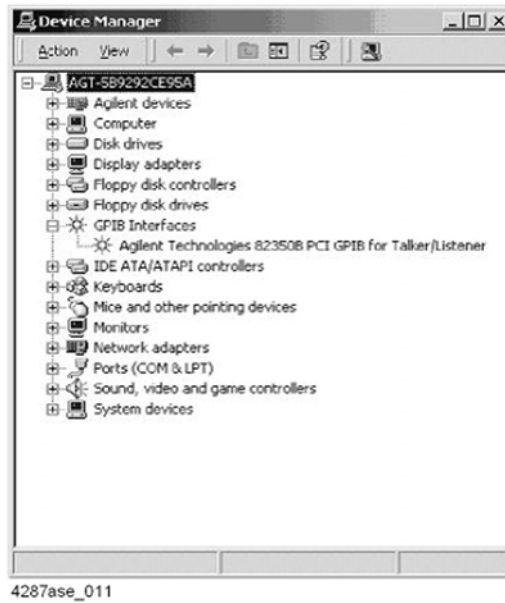

Figure 4-23 System Properties Window (General)



Step 3. Click Hardware tab and Device Manager button. The operating system detects all the necessary device drivers and displays the device names as shown in Figure 4-24.

Figure 4-24 System Properties Window (Hardware)



Click the icon with the right button and click Property to show the detail of the status, as shown in Figure 4-25.

Figure 4-25 Opening Device Driver Property

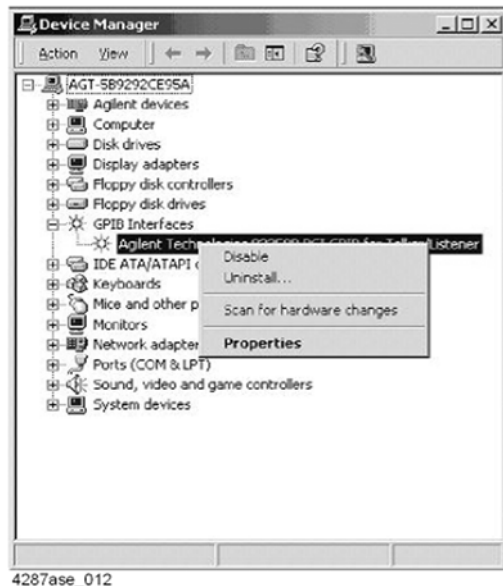

To check the Front Panel

Procedure

Randomly press the front panel keys and rotate the knob to verify that they work correctly. If any fail to work, it assumes that the A22 Front keyboard or A21 Analog Interface board gives problem. Or, it assume that any front panel key has been subsided in the panel.

To check the LCD and Back Light

Procedure

- Step 1.** Perform the LCD test in service function by following front panel procedure.
[Alt] - [7] - [7] - [2]
- Step 2.** Then display (LCD) test starts, whole the LCD color changes, red, green, blue, white and black in order. Make sure that condition such a intensity and dot off is no problem.
If any fail to work, there is a possibility that the A51 LCD gives problem.
- Step 3.** Perform the Balk Light [ON/OFF] in service function by following front panel procedure.
[Alt] - [7] - [7] - [3]

To check the External Keyboard

Procedure

- Step 1.** Connect the external keyboard to the 4287A rear.
- Step 2.** Turn the 4287A on.
- Step 3.** Press the [↑], [↓] keys on the external keyboard, and make sure that the cursor on the menu bar moves to up or down. If any fail to work, there is a possibility that the external keyboard or the A20 Digital Motherboard gives problem.

To check the Mouse

Procedure

- Step 1.** Connect the mouse to the 4287A rear.
- Step 2.** Turn the 4287A on.
- Step 3.** Move the mouse and press the mouse buttons, and make sure that the mouse pointer moves smoothly and the mouse buttons work correctly. If any fail to work, there is a possibility that the mouse or the A20 Digital Motherboard gives problem.

To check the FDD

Procedure

- Step 1.** Inset the floppy disk into the 4287A FDD.
- Step 2.** Click the followings. Then “Save As” dialog box is displayed.

Save/Recall - SAVE STATE

- Step 3.** Select the drive and file name as follows;

Save in: 3 1/2 Floppy [A]

File name: 4287a

Then, click **Save**. If any fail to work, there is a possibility that the floppy disk, the A28 FDD or the flat cables between the FDD and the A20 Digital Motherboard via the A26 Display board gives problem.

- Step 4.** Next, click the followings to recall the state file you saved. Then “Open” dialog box is displayed.

Save/Recall - RECALL STATE

- Step 5.** Select the drive and file name as follows;

Look in: 3 1/2 Floppy [A]

File name: 4287a

Then, click **Open**. If any fail to work, there is a possibility that the floppy disk, the A28 FDD or cable between the FDD and the A20 Digital Motherboard gives problem.

To check the VGA Display Output

Procedure

- Step 1.** Connect the external monitor to the 4287A rear.
- Step 2.** Turn the external monitor on.
- Step 3.** Make sure that the screen on the external monitor is same as the screen on the LCD. If screen is not displayed on the external monitor, there is a possibility that the A26 Display board give problem.

To check the External Trigger Input

Procedure

- Step 1.** Select the trigger source to “EXTERNAL” by following front panel procedure.
[Alt] - [5] - [1] - [3]
- Step 2.** Attach the 50ohm termination to the 4287A Ext Trig connector rear, then triggers a measurement once and measurement data is displayed.
- Step 3.** Remove the 50ohm termination from the 4287A Ext Trig connector rear, then triggers a measurement once and measurement data is displayed.
- Step 4.** If measurement doesn't execute under the external trigger in spite of the internal trigger works properly, there is a possibility that the A21 Analog Interface board gives problem.

To check the LAN (for serial prefix JP1KG, JP2KG, and MY432)

Procedure

- Step 1.** Connect the LAN cable between the 4287A rear and the personal computer. If you have a crossed LAN cable, it is available to connect with them directly as shown in Figure B-15, “LAN connection with cross cable,” on page 253. Or, if have a straight LAN cable, it is available to connect with them via multi port Hub as shown in Figure B-16, “LAN connection with straight cables,” on page 253.
- Step 2.** Click the followings. Then “Network Address Setup” dialog box is displayed. If IP Address, Gateway, and Net Mask are not assigned yet, enter them. If you are unfamiliar about LAN settings, talk to your PC administrator.

System - LAN SETUP - SETUP IP ADDRESS

- Step 3.** Click the followings. Then network status as “[ENABLE]” is displayed at the menu bar.

System - LAN SETUP - NETWORK DEVICE[ENABLE]

- Step 4.** Turn the 4287A off, and turn it again on. The LAN settings take effect.
- Step 5.** Open the DOS prompt by following the mouse procedure from personal computer.

Start - Programs - MS-DOS Prompt

You can confirm whether the 4287A LAN hardware and setting is available or not using ping command. Type “ping xxx.xxx.xxx.xxx”, and press **[Enter]** key from the Command

Troubleshooting

Function Depend Troubleshooting

Prompt window. Where “xxx.xxx.xxx.xxx” is the IP address of the 4287A you assigned.

Figure 4-26 and Figure 4-27 are examples of the ping command response. When the 4287A returns response to the personal computer, such a Figure 4-26 is displayed. When the 4287A doesn't return the response, such a Figure 4-27 is displayed.

If the 4287A doesn't return the response, there is a possibility that the A25 LAN Interface board gives problem.

Figure 4-26

Example of the ping command succeeds

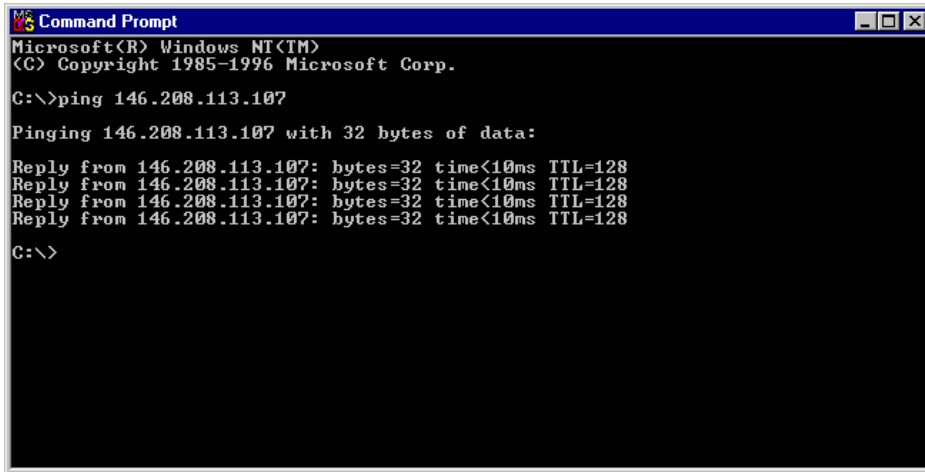

```
Microsoft Windows [Version 4.0.9506]
(c) Copyright 1985-1996 Microsoft Corp.

C:\>ping 146.208.113.107

Pinging 146.208.113.107 with 32 bytes of data:

Reply from 146.208.113.107: bytes=32 time<10ms TTL=128
Reply from 146.208.113.107: bytes=32 time<10ms TTL=128
Reply from 146.208.113.107: bytes=32 time<10ms TTL=128
Reply from 146.208.113.107: bytes=32 time<10ms TTL=128

C:\>
```

Figure 4-27

Example of the ping command fails

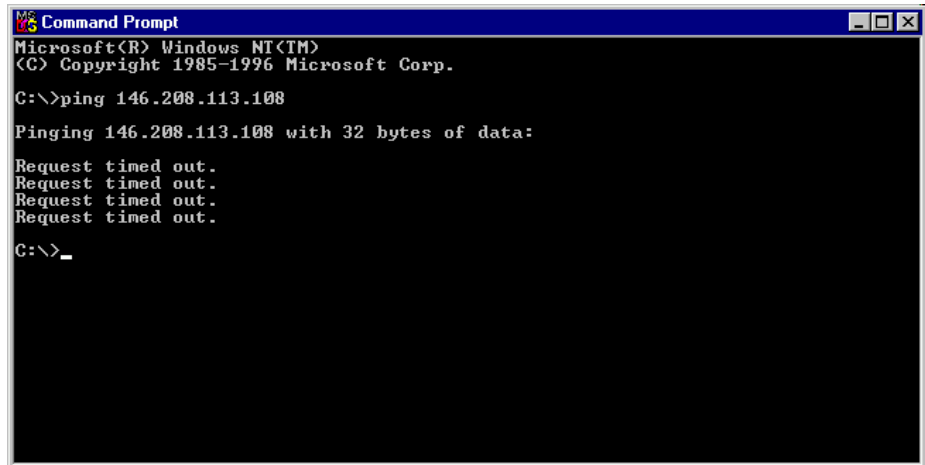

```
Microsoft Windows [Version 4.0.9506]
(c) Copyright 1985-1996 Microsoft Corp.

C:\>ping 146.208.113.108

Pinging 146.208.113.108 with 32 bytes of data:

Request timed out.
Request timed out.
Request timed out.
Request timed out.

C:\>_
```

To Check the LAN (for serial prefix MY433 and later)

Procedure

- Step 1.** Exit from the 4287A Measurement Display as shown in “Service Mode and Instrument Mode” on page 97. Then windows desktop screen is displayed.
- Step 2.** Connect a LAN cable between the LAN port on the rear panel and an external computer (PC).

NOTE

Use a crossed LAN cable to enable the peer-to-peer communication between the 4287A and the PC. If the 4287A needs to be connected to the PC via a multi port Hub, use a straight LAN cable.

- Step 3.** Double-click “**My Computer**” icon on Windows desktop of the 4287A. And double-click “**Control Panel**”. The Control Panel window will appear.
- Step 4.** Double-click “**Network and Dial-up Connections**” icon to show the Network and Dial-up Connections window as shown in the left of Figure 4-28.

Figure 4-28

Network and Dial-up Connections window

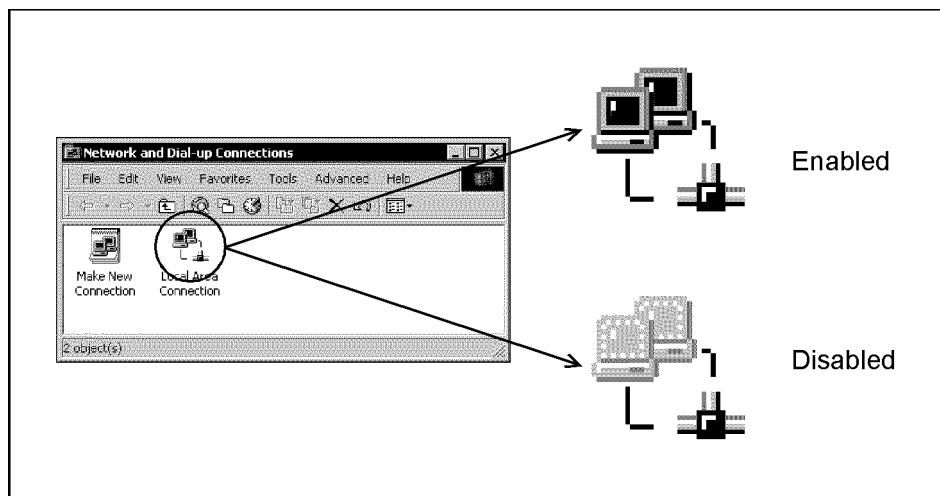

- Step 5.** Check the Local Area Connection icon to confirm whether the network connection is enabled or disabled. The meaning of the icon is shown in the right of Figure 4-28. If the connection is disabled, Double-click the Local Area Connection icon.
- Step 6.** Set up the IP address/subnet mask as follows.
 - a.** Click the Local Area Connection icon with the right button and click “Properties”. This opens the “Local Area Connection Properties” dialog box as shown in Figure 4-29.

Figure 4-29 Network dialog box

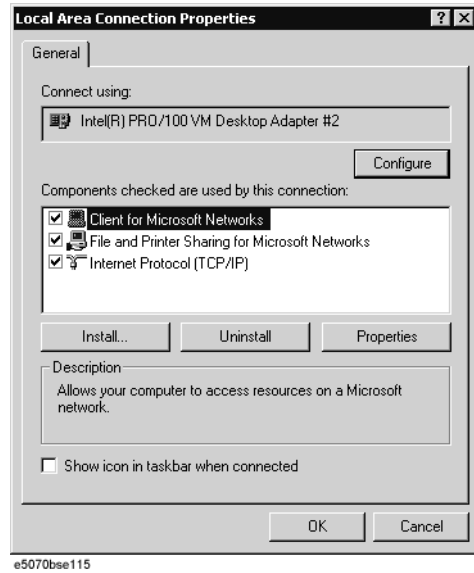

- b. Click "Internal Protocol (TCP/IP)" icon.
- c. Click the "Properties" button. This opens the "TCP/IP Properties" dialog box as shown in Figure 4-30.

Figure 4-30 TCP/IP Properties dialog box (IP Address tab)

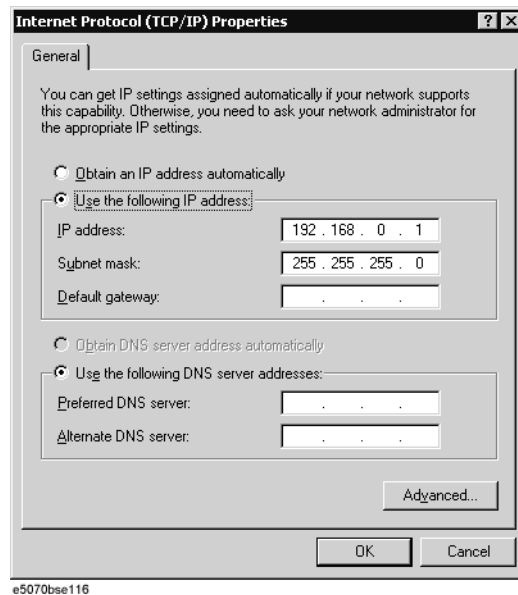

- d. If the IP Address and the Subnet Mask are already assigned, go to Step 7. If they are not assigned yet, enter them as follows:

IP Address 192.168.0.1
Subnet Mask 255.255.255.0
Default Gateway blank

To enter a specific IP Address and Subnet Mask, click "Use the following IP address"

option button to select it. Input your IP address in the "IP Address" box and your subnet mask in the Subnet Mask box (overwrite the initial values).

- Step 7.** By clicking "OK" button, the network settings take effect. Verify the 4287A LAN settings and response to a command from the external computer as follows:
- On the external computer, click "Start" button in the Windows Start menu bar using a mouse.
 - Click "Programs" and "Accessories" and "Command Prompt" to open the DOS (Command) Prompt window.
 - Type a ping command followed by the 4287A IP address as "ping xxx.xxx.xxx.xxx" (where, xxx.xxx.xxx.xxx is the IP address such as 192.168.0.1 assigned in Step 6-d.) Press key on the keyboard.
 - The external computer displays a message of ping command response from the 4287A. Figure 4-31 shows an example of normal result that indicates the IP address, packet size, and a response time counted by the computer. The ping command is repeated 4 times.

Figure 4-31 Example of normal ping command test result

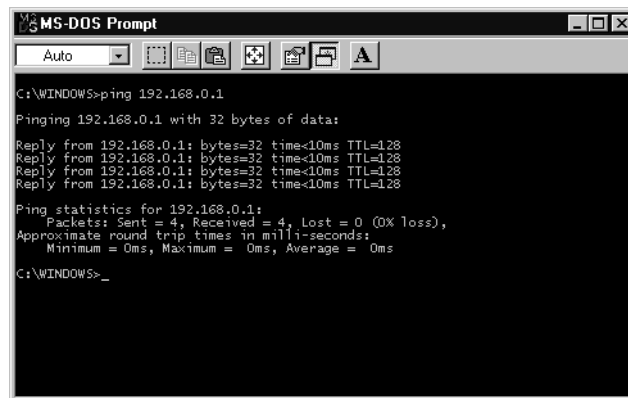

```
MS-DOS Prompt
Auto
C:\WINDOWS>ping 192.168.0.1
Pinging 192.168.0.1 with 32 bytes of data:
Reply from 192.168.0.1: bytes=32 time<10ms TTL=128
Reply from 192.168.0.1: bytes=32 time<10ms TTL=128
Reply from 192.168.0.1: bytes=32 time<10ms TTL=128
Reply from 192.168.0.1: bytes=32 time<10ms TTL=128

Ping statistics for 192.168.0.1:
    Packets: Sent = 4, Received = 4, Lost = 0 (0% loss),
    Approximate round trip times in milli-seconds:
        Minimum = 0ms, Maximum = 0ms, Average = 0ms

C:\WINDOWS>
```

If the 4287A doesn't return the response, the external computer displays a message of "Request timed out" as shown in Figure 4-32. In this case, a failure in the A20 digital motherboard is suspected.

Figure 4-32 Example of no response for ping command

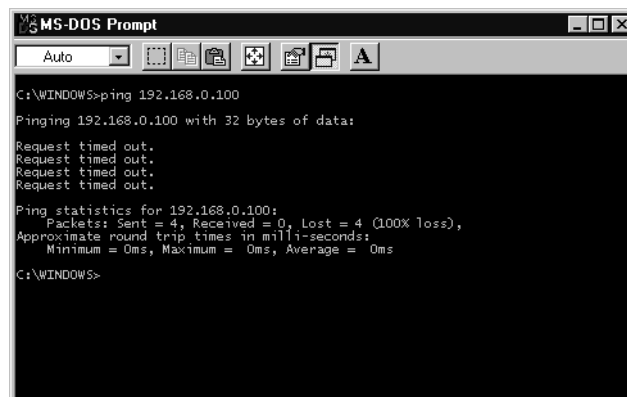

```
MS-DOS Prompt
Auto
C:\WINDOWS>ping 192.168.0.100
Pinging 192.168.0.100 with 32 bytes of data:
Request timed out.
Request timed out.
Request timed out.
Request timed out.

Ping statistics for 192.168.0.100:
    Packets: Sent = 4, Received = 0, Lost = 4 (100% loss),
    Approximate round trip times in milli-seconds:
        Minimum = 0ms, Maximum = 0ms, Average = 0ms

C:\WINDOWS>
```

To check the Handler Interface

The 4287A handler interface is tested using the handler interface simulator.

Test Equipment

Description	Recommended Model
Handler Interface Simulator	P/N 04278-65001

Procedure

- Step 1.** Select the trigger source to “EXTERNAL” by following front panel procedure.
[Alt] - [5] - [1] - [3]
- Step 2.** Set three switches on the 4287A handler interface simulator to ON (outside position).
- Step 3.** Connect the handler interface simulator and the 4287A handler interface connector as shown in Figure 4-33.

Figure 4-33

Handler Interface Test Setup

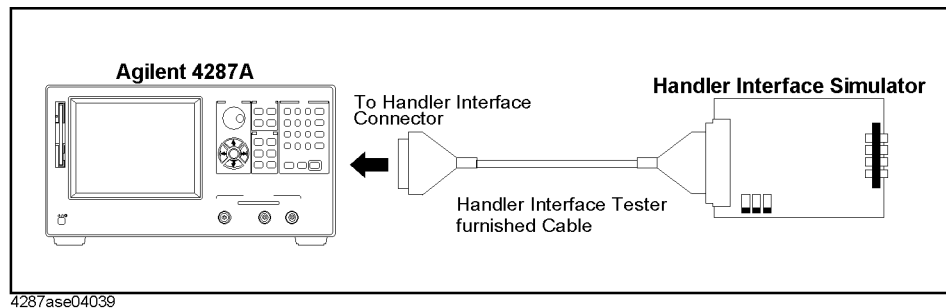

- Step 4.** Make sure whether the following LED on the handler interface simulator light or not as follows;
LED of the EOM, Ext. Trig, INDEX and CH.1 ON
LED except above OFF
- Step 5.** Set the KEYLOCK switch on the handler interface simulator to ON (outside position).
- Step 6.** Make sure that the all keys and knob on the 4287A front panel are locked out.
- Step 7.** Set the KEYLOCK switch on the handler interface simulator to OFF (inside position).
- Step 8.** Make sure that the all keys and knob on the 4287A front panel work correctly.
- Step 9.** Toggle on and off the START/STOP switch on the handler simulator.
- Step 10.** Make sure that the LED of the Ext.Trig lights or not synchronous with the START/STOP switch position, and the 4287A starts and stops the measurement synchronous with the START/STOP switch position.
- Step 11.** If any fail to work, there is a possibility that the A23 Handler Interface board gives problem. If the handler interface test still fails after replacing the A23, replace the A21 Analog Interface board.

To check the GPIB

Procedure

Perform the 4287A performance test program. If the controller can not find the 4287A, there is a possibility that the A24 GPIB board or connection of the GPIB cable gives problem.

To check the Printer Parallel port (for serial prefix JP1KG, JP2KG, and MY432)

Test Equipment

Please refer

http://www.agilent.com/find/ctdkobe_printers

for the latest supported printers.

Printer Cable (Parallel Cable)

Procedure

- Step 1.** Connect the printer cable between the printer and the 4287A printer parallel port.
- Step 2.** Press [**Preset**] key. Then the 4287A is initialized.
- Step 3.** Select the default printer by following mouse procedure.
Display - PRINT MENU - SELECT DEFAULT PRINTER - Default: - OK
- Step 4.** Start printing by following mouse procedure. Then the 4287A starts color printing with colors close to those of the actual screen display.
Display - PRINT MENU - PRINT
- Step 5.** If any fail to work, there is a possibility that the A20 Digital Mother board or connection of the printer cable gives problem.

Analog Section Troubleshooting

Performance Tests Failure Troubleshooting

Perform the following procedure sequentially when any performance tests fail.

Perform Adjustment

Table 4-2 gives the recommended adjustments when the performance test fails. You should perform the corresponding adjustments as shown in Table 4-2. If the performance test still fails, replace the assembly as shown in Table 4-3.

Note that this table lists some typical cases. In a few cases, other assembly may actually be faulty.

Table 4-2

Recommended Adjustment for Performance Test Failure

Test No.	First Failed Test	Adjustment								
		A1 VCXO FREQ Adj	A3 LOCAL LEVEL Adj	A3 AGC GAIN Adj	A3 OUTPUT LEVEL Adj	A4 AGC GAIN Adj	A4 LOCAL LEVEL Adj	A4 IF GAIN Adj	A4 RF Gain Adj	A4 DC Gain Adj
1	Frequency Accuracy Test	√								
2	Power Level Accuracy Test		√	√	√					
3	Impedance Measurement Accuracy Test		√	√	√	√	√	√		
4	DC Resistance Measurement Accuracy Test									

Table 4-3

Isolate Faulty Assembly for Performance Test Failure

Test No.	First Failed Test	Probable Faulty Assembly		
		A1 Ref OSC	A3 Source	A4 Receiver
1	Frequency Accuracy Test	†††		
2	Power Level Accuracy Test		†††	
3	Impedance Measurement Accuracy Test		††	†††
4	DC Resistance Measurement Accuracy Test		†††	††

†††: Most suspicious assembly

††: Suspicious assembly

Fails in specific setting

The following is a supplementary information for repair of the analog section. When you encounter a problem, and you can notice that the failure occurs in specific setting as follows, a faulty assembly can be isolated easily.

Fails in specific frequency

If the frequency test fails in specific setting, defective assembly would be isolated.

Frequency range of each bands		Assemblies	
Lower Freq	Upper Freq	A1	A3
1 MHz	1739.9 MHz	Band 1 path	Band 1 path
1740 MHz	2259.9 MHz	Band 2, Band 3, Band 4 common path	Band 2 path
2260 MHz	2679.9 MHz		Band 3 path
2680 MHz	3000 MHz		Band 4 path

If the frequency accuracy test fails only in band 2, band 3, or band 4, A3 might be defective. If else, go to synthesize isolation to isolate from A1 or A3.

Fails in specific output power level

If the power level accuracy test fails in specific setting, defective assembly would be isolated.

Setting for output power level		Attenuator setting on A3 : Affect to Output Power Level	Range setting on A4: Affect to Impedance Accuracy
Lower Level	Upper Level		
-7.9 dBm	+1 dBm	0 dB	Range 1
-12.9 dBm	-8 dBm	5dB	
-17.9 dBm	-13 dBm	10 dB	Range 2
-22.9 dBm	-18 dBm	15 dB	
-27.9 dBm	-23 dBm	20 dB	Range 3
-32.9 dBm	-28 dBm	25 dB	
-37.9 dBm	-33 dBm	30 dB	
-40 dBm	-38 dBm	35 dB	

If the power level accuracy test fails only in specific attenuator setting, A3 might be defective. Also, If test fails in specific range1, range2 or range3, A4 might be defective.

Troubleshooting by Each Assembly

The following is a supplementary information for repair of the analog section. The 4287A analog section consists of synthesizer block, source block, receiver block and A6 Test Head. If the failure doesn't occur specific symptom, troubleshoot it one by one.

Synthesizer Isolation

If synthesizer block has failure, the failure is in A1 REF OSC.

Equipment

Spectrum analyzer that requires following specification

Frequency Range	1 MHz ~ 3 GHz
Frequency Accuracy	≤ 1 ppm, synthesized
Function	Peak search, Counter

Connections

Connect the 10 MHz reference out of the spectrum analyzer to 4287A's 10 MHz Ext Ref In using a BNC cable to lock the 4287A to the spectrum analyzer's reference.

Remove front panel from the 4287A, but keep connection of cables between front panel and main frame. Then remove two semi rigid cables between A1 and A3. And connect RF1 OUT/RF2 OUT connector on the A1 to the spectrum analyzer.

4287A and Spectrum Analyzer Setting

4287A Setting			Spectrum Analyzer setting	
Frequency	Power Level	Trigger	Center Frequency	Span
1 MHz *1	-20 dBm	Internal	2304 MHz	100 kHz
3 GHz *1	-20 dBm	Internal	1152 MHz	100 kHz

*1. One point measurement is recommended.

Measurement and Limit

4287A Setting	Limit for RF1 OUT		Limit for RF2 OUT	
	Freq Limit	Level Limit	Freq Limit	Level Limit
1 MHz	2303.9875 MHz ±1 kHz	+6dB ±2dB	2304 MHz ±1 kHz	+6dB ±2dB
3 GHz	1151.9875 MHz ±1 kHz	+6dB ±2dB	1152 MHz ±1 kHz	+6dB ±2dB

Receiver Isolation

Receiver block consists of A4 RECEIVER.

Equipment

Power Splitter, type N	11667A
20 dB attenuator, type N	8491A Opt 020
Cable, type N	11500B

Connections

- Step 1.** Remove cables from the 4287A front panel.
- Step 2.** Connect the 20 dB attenuator to 4287A RF OUT.
- Step 3.** Connect the power splitter’s input port to the attenuator.
- Step 4.** Connect the power splitter’s output ports to 4287A PORT 1 and PORT 2 using two N cables.

4287A and Spectrum Analyzer Setting

	4287A Settings		
	Frequency	Power Level	Trigger
Table 1	1M, 10M, 100M, 200M, 300M, 500M, 600M, 800M, 1G, 1.3G, 1.6G, 1.8G, 2G, 2.2G, 2.4G, 2.6G, 2.8G, 3GHz	0 dBm	Manual
Table 2	ditto	-20 dBm	Manual
Table 3	ditto	-40 dBm	Manual

Measurement and Limit

Trigger it manually 5 times. Measured value of |Z| will be around 1 ohm, if the receiver circuit is normal.

Frequency	Limit
All	1.000 Ω±0.005 Ω

To Configure the A20 Digital Motherboard and BIOS (for serial prefix JP1KG, JP2KG, and MY432)

If you replace the A20 Digital Motherboard, you need to confirm the jumpers for the specific CPU installed. You also need to confirm the BIOS options using the BIOS setup utility procedure. And, the BIOS detects the A27 Mass Storage connected to the A20, and displays these parameters. It is a useful tool to verify whether the A27 gives problem or not.

The jumpers on the A20 and the BIOS setups are presented in the following pages.

To Identify the Motherboard Used

The 4287A came equipped with Digital Motherboard and Intel Pentium (MMX) 233MHz microprocessor. This motherboard displays the message “Agilent Technologies 04287-61020” and “Pentium(MMX), 233MHz” as shown in Figure 4-9.

Configure the Motherboard

There are several jumpers on the A20 Digital Motherboard that must be configured to the correct settings for the Intel Pentium(MMX) 233MHz microprocessor as shown in Table 4-4 to Table 4-11. Figure 4-34 shows the A20 digital motherboard jumpers location.

Table 4-4

JP1

1-2	2-3
OFF	ON

Table 4-5

JP2

1-2	3-4	5-6	7-8
ON	OFF	OFF	OFF

Table 4-6

JP3 CPU Speed (Intel MMX 233MHz)

1-2	3-4	5-6
OFF	OFF	OFF

Table 4-7

JP4 BUS Clock (66MHz)

1-2	3-4	5-6
OFF	OFF	ON

Table 4-8

JP7 BIOS Write Protect (Non Writable)

1-2	2-3
ON	OFF

Table 4-9

JP9 CMOS Reset (Normal)

1-2	2-3
ON	OFF

Table 4-10

JP10 CPU Voltage Selection (2.8V)

1-2	3-4	5-6	7-8
OFF	OFF	OFF	ON

Table 4-11

JP11 Power On Select

1-2	2-3
ON	OFF

NOTE If the jumper settings, especially jumper 3, 4, or 10 is incorrect, there is a possibility that it gives damage to the microprocessor. You must be attentive to configure the jumpers.

Figure 4-34 A20 Digital Motherboard Jumpers Location

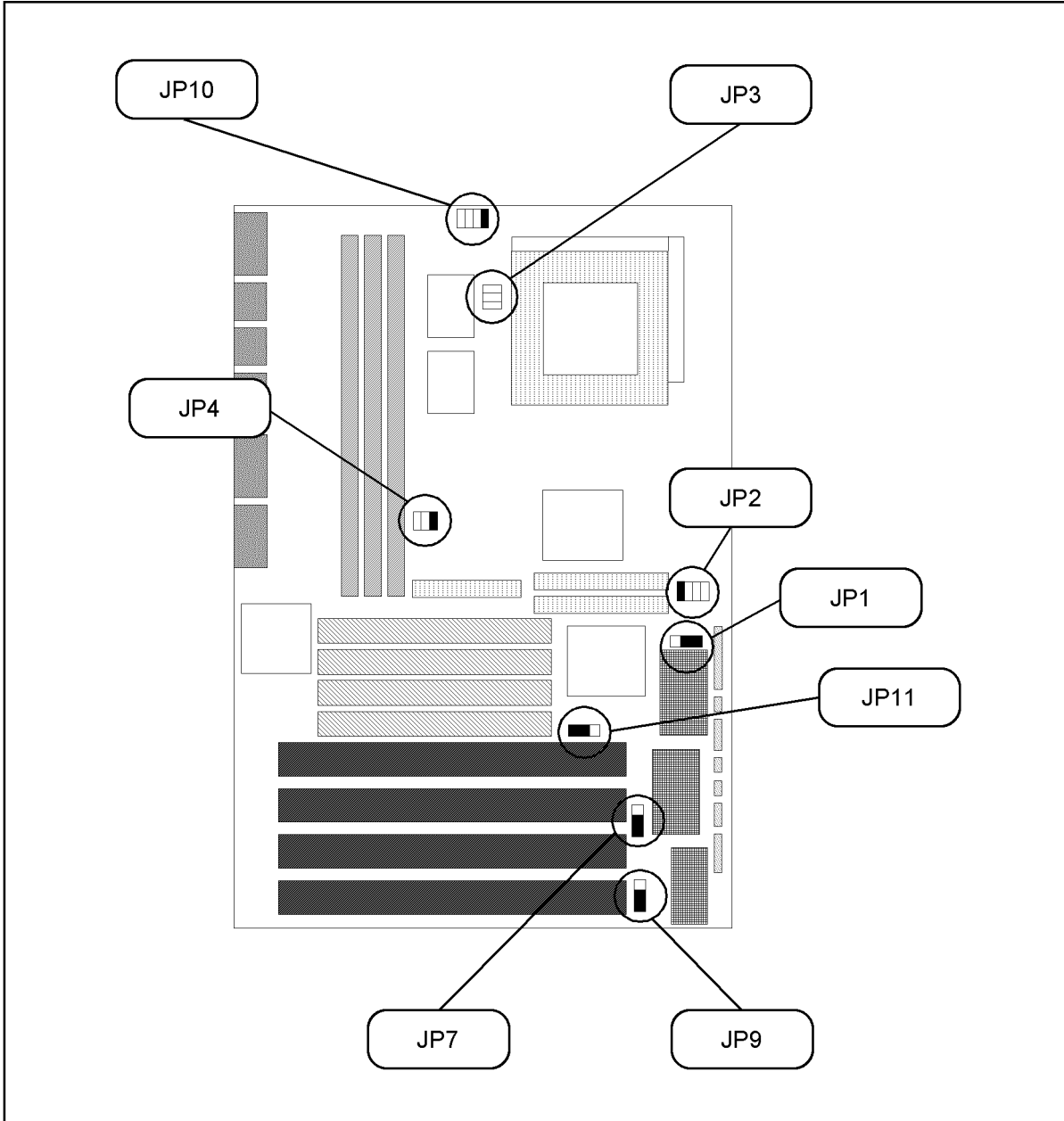

4287ase04011

To Configure the A20 Digital Motherboard and BIOS (for serial prefix JP1KG, JP2KG, and MY432)

To Confirm or Set the BIOS Options

Generally, BIOS (Basic Input Output System) is a software to control the data input/output of the personal computer. The 4287A has the BIOS inside. Use the following procedure to confirm or set the BIOS options, known as the BIOS setup utility.

Run the BIOS setup utility

You can use the external keyboard in the BIOS setup utility to perform various functions.

- Step 1.** Connect the external keyboard to the 4287A rear panel. Then turn the 4287A on.
- Step 2.** Hit **[Delete]** key as soon as the message of “Hit DEL if you want to run SETUP” is displayed.
- Step 3.** Enter password as “kid” when you are required it. Then Figure 4-35 is displayed.

Figure 4-35

BIOS setup utility main menu Page

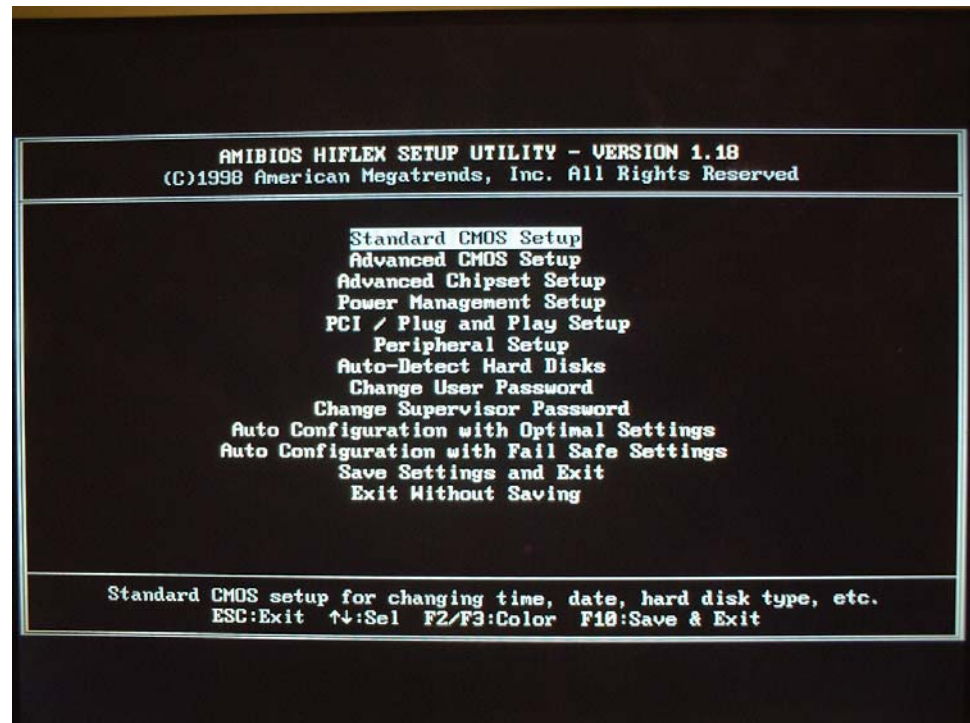

The BIOS setup utility has 11 windows. For details of the BIOS options in the each window are described in bellow pages. You can select a window using **[↑]**, **[↓]** keys or **[Tab]** key, and perform an operation using **[Enter]** key.

The windows are:

- Standard CMOS Setup

The default settings of all the Standard CMOS Setup options are described in the “Standard CMOS Setup” on page 141.

- Advanced CMOS Setup

The default settings of all the Advanced CMOS Setup options are described in the “Advanced CMOS Setup” on page 142.

- Advanced Chipset Setting

The default settings of all the Advanced Chipset Setting options are described in the “Advanced Chipset Setup” on page 143.

- Power Management Setup

The default settings of all the Power Management Setup options are described in the “Power Management Setup” on page 144.

- PCI/Plug and Play Setup

The default settings of all the PCI/Plug and Play Setup options are described in the “PCI / Plug and Play Setup” on page 145.

- Peripheral Setup

The default settings of all the Peripheral Setup options are described in the “Peripheral Setup” on page 146.

- Auto-Detect Hard Drive

After replacing the A27 Mass Storage, you can confirm whether the connection between the A27 and the A20 Digital Motherboard is good or not. Because, BIOS automatically configures the drive parameters after A27 has detected.

- Change User Password

This option is unnecessary to use in the 4287A.

- Change Supervisor Password

- Auto Configuration With Optimal Settings

This option is unnecessary to use in the 4287A.

- Auto Configuration With Fail Safe Settings

This option is unnecessary to use in the 4287A.

- Save Settings and Exit

If you want to quit from BIOS setup utility without saving, select a “Exit Without Saving”. For details, refer to “Exit Without Saving” on page 148.

- Exit Without Saving

If you want to quit from BIOS setup utility with saving, select a “Save Setting and Exit”. For details, refer to “Save Settings and Exit” on page 148.

To Configure the A20 Digital Motherboard and BIOS (for serial prefix JP1KG, JP2KG, and MY432)

Standard CMOS Setup

Standard Setup options are displayed by choosing “Standard CMOS Setup” using [↑], [↓] keys and hit [Enter] key at the BIOS setup utility main menu. Then Figure 4-36 is displayed. If date or time is incorrect, change it using [↑], [↓] keys, [PageUp] key and [PageDown] key. If you want to exit from this page, and go to main menu, hit [ESC] key.

Figure 4-36

STANDARD CMOS SETUP Page

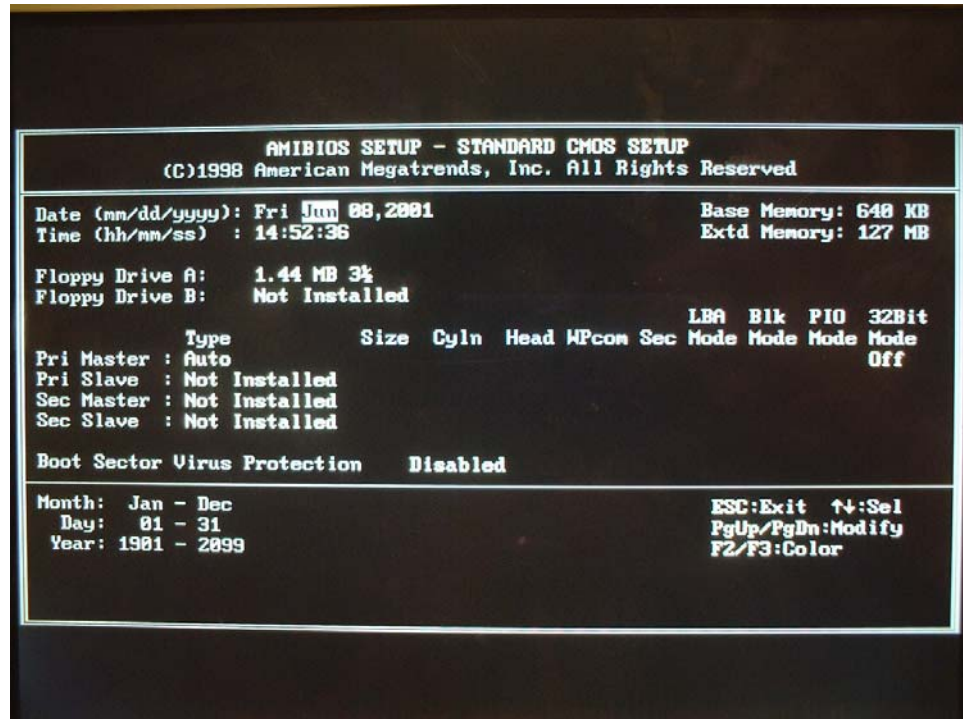

Troubleshooting

To Configure the A20 Digital Motherboard and BIOS (for serial prefix JP1KG, JP2KG, and MY432)

Advanced CMOS Setup

Advanced CMOS Setup options are displayed by choosing “Standard CMOS Setup” using [↑], [↓] keys and hit [Enter] key at the BIOS setup utility main menu. Then Figure 4-37 is displayed. Compare the default BIOS options as shown in Figure 4-37 with your 4287A’s BIOS options. If there is difference, change BIOS option using [↑], [↓] keys, [PageUp] key and [PageDown] key. If you want to exit from this page, and go to main menu, hit [ESC] key.

Figure 4-37

ADVANCED CMOS SETUP Page

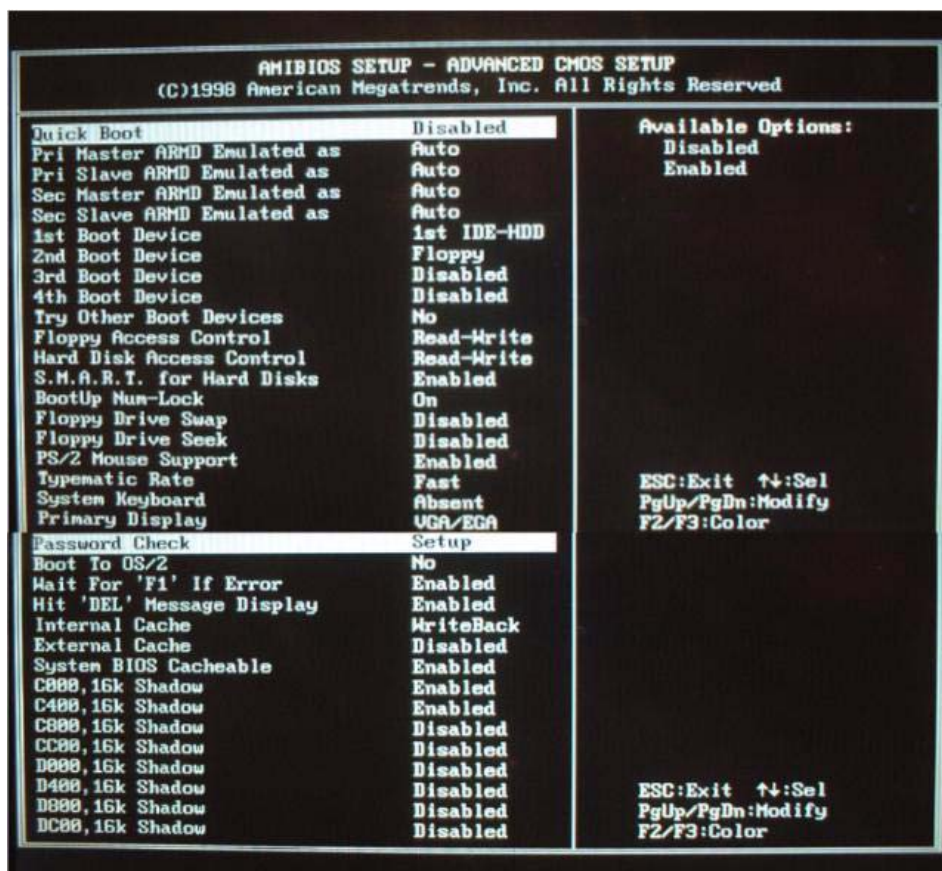

To Configure the A20 Digital Motherboard and BIOS (for serial prefix JP1KG, JP2KG, and MY432)

Advanced Chipset Setup

Advanced Chipset Setup options are displayed by choosing “Advanced Chipset Setup” using [↑], [↓] keys and hit [Enter] key at the BIOS setup utility main menu. Then Figure 4-38 is displayed. Compare the default BIOS options as shown in Figure 4-38 with your 4287A’s BIOS options. If there is difference, change BIOS option using [↑], [↓] keys, [PageUp] key and [PageDown] key. If you want to exit from this page, and go to main menu, hit [ESC] key.

Figure 4-38

ADVANCED CHIPSET SETUP page



Troubleshooting

To Configure the A20 Digital Motherboard and BIOS (for serial prefix JP1KG, JP2KG, and MY432)

Power Management Setup

Power Management Setup options are displayed by choosing “Power management Setup” using **[↑]**, **[↓]** keys and hit **[Enter]** key at the BIOS setup utility main menu. Then Figure 4-39 is displayed. Compare the default BIOS options as shown in Figure 4-39 with your 4287A’s BIOS options. If there is difference, change BIOS option using **[↑]**, **[↓]** keys, **[PageUp]** key and **[PageDown]** key. If you want to exit from this page, and go to main menu, hit **[ESC]** key.

Figure 4-39

POWER MANAGEMENT SETUP Page

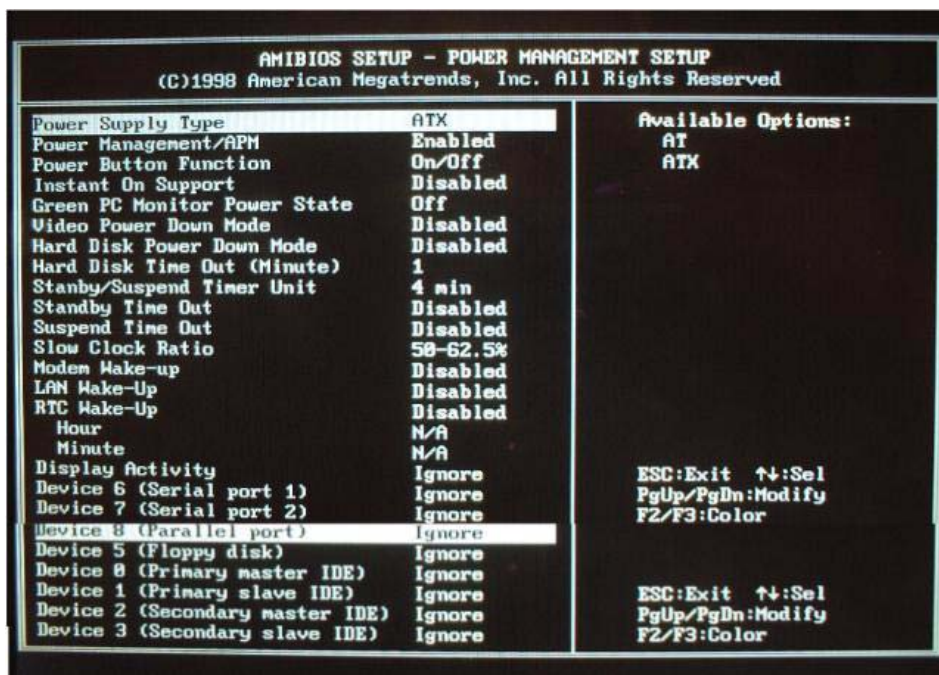

To Configure the A20 Digital Motherboard and BIOS (for serial prefix JP1KG, JP2KG, and MY432)

PCI / Plug and Play Setup

PCI/Plug and Play Setup options are displayed by choosing “PCI / Plug and Play Setup” using [↑], [↓] keys and hit [Enter] key at the BIOS setup utility main menu. Then Figure 4-40 is displayed. Compare the default BIOS options as shown in Figure 4-40 with your 4287A’s BIOS options. If there is difference, change BIOS option using [↑], [↓] keys, [PageUp] key and [PageDown] key. If you want to exit from this page, and go to main menu, hit [ESC] key.

Figure 4-40

PCI / PLUG AND PLAY SETUP Page

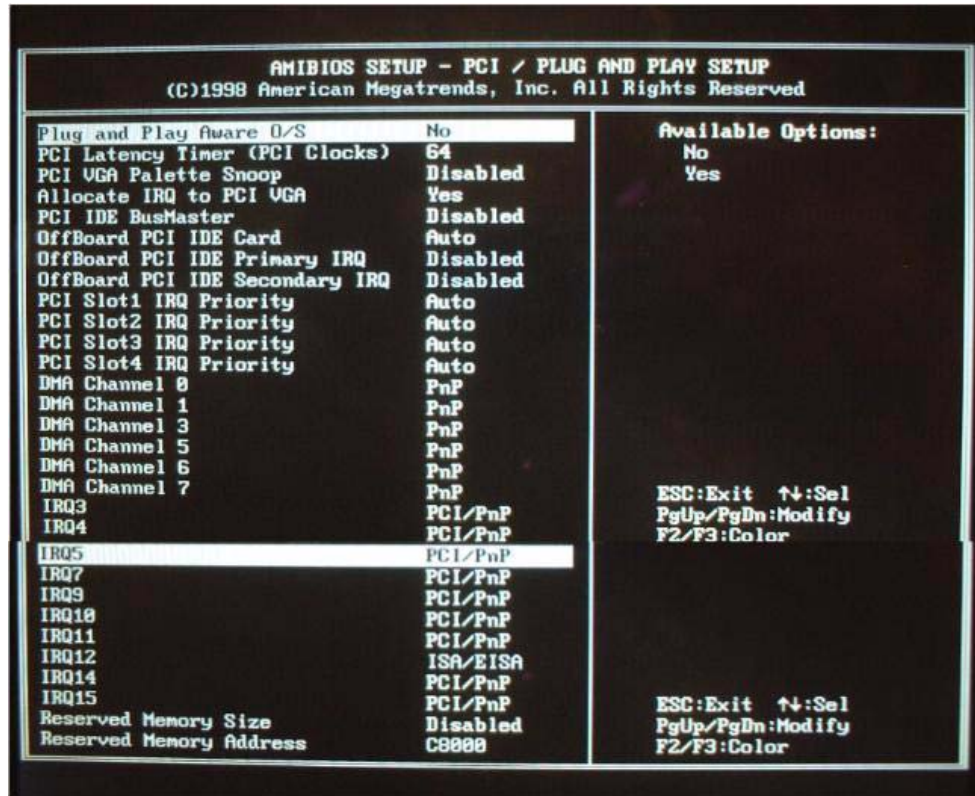

Troubleshooting

To Configure the A20 Digital Motherboard and BIOS (for serial prefix JP1KG, JP2KG, and MY432)

Peripheral Setup

Peripheral Setup options are displayed by choosing “Peripheral Setup” using [↑], [↓] keys and hit [Enter] key at the BIOS setup utility main menu. Then Figure 4-41 is displayed.

Compare the default BIOS options as shown in Figure 4-41 with your 4287A’s BIOS options. If there is difference, change BIOS option using [↑], [↓] keys, [PageUp] key and [PageDown] key. If you want to exit from this page, and go to main menu, hit [ESC] key.

Figure 4-41

PERIPHERAL SETUP Page

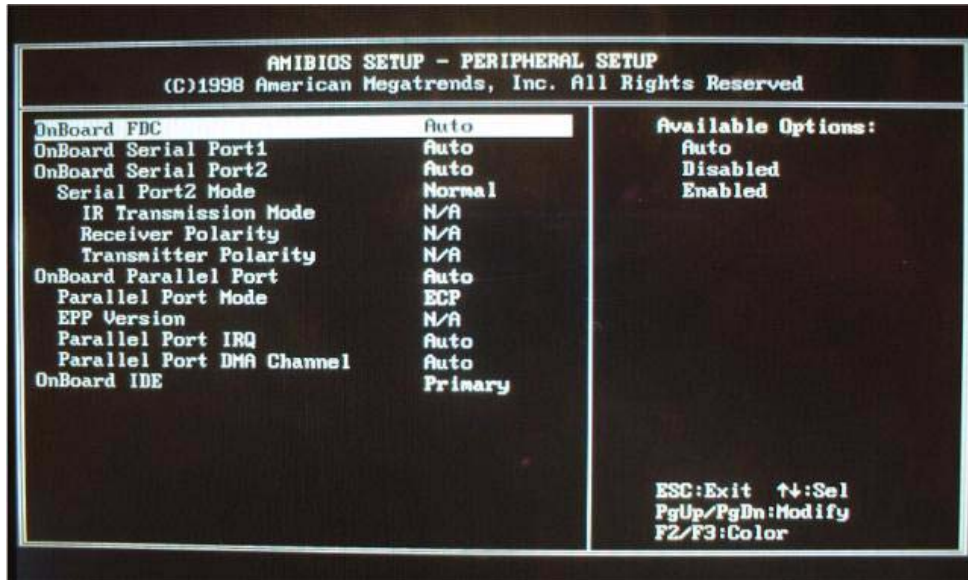

To Configure the A20 Digital Motherboard and BIOS (for serial prefix JP1KG, JP2KG, and MY432)

Auto-Detect Hard Disks

Auto-Detect Hard Disks options are displayed by choosing “Auto-Detect Hard Disks” using [↑], [↓] keys and hit [Enter] key at the BIOS setup utility main menu. Then Figure 4-42 is displayed. You can find A27 mass storage (hard disk or flash disk) drive parameters for IDE1 drive connected to the primary channel installed in the A20 Digital Motherboard. If you doubt the mass storage doesn’t work properly, make sure that the 4287A system detects the mass storage correctly using this option.

Figure 4-42

AUTO-DETECT HARD DISK SETUP Page

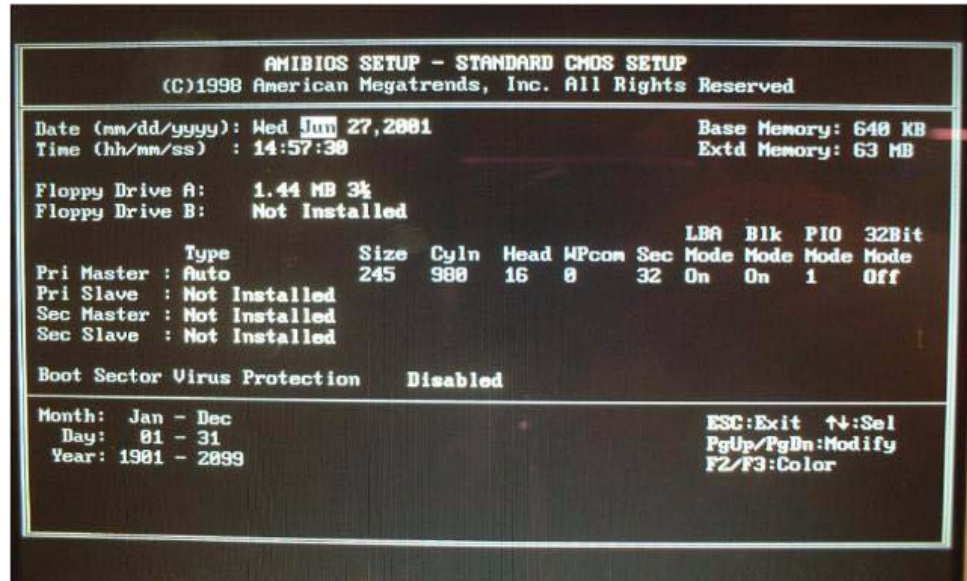

Change Supervisor Password

Usually, you are required a password first, when the BIOS setup utility is executed. If a password is not assigned in your 4287A, set it using BIOS setup utility. Move the cursor to “Change Supervisor Password” using [↑], [↓] keys and hit [Enter] key at the BIOS setup utility main menu, and you have to set the password to “kid”, don’t set it to others.

Save Settings and Exit

It is necessary to save BIOS options before exit on the BIOS setup utility, when you want to change and save a BIOS option. Move the cursor to “Save Settings and Exit” using [↑], [↓] keys and hit [Enter] key at the BIOS setup utility main menu. Then, the message of “Save current settings and exit (Y/N) ?” is displayed. If yes, hit [Y] key. Then, the BIOS setup utility is closed.

Exit Without Saving

If you cancel the changes of the BIOS options, move the cursor to “Exit Without Saving” using [↑], [↓] keys and hit [Enter] key at the BIOS setup utility main menu. Then, the message of “Quit without saving (Y/N) ?” is displayed. If you want to quit without saving, hit [Y] key. Then, the BIOS setup utility is closed.

To Configure the A20 Digital Motherboard and BIOS (for serial prefix MY433 and later)

When you replace the A20 digital motherboard, you need to confirm the jumper settings for the specific CPU installed. The jumper settings information is provided in “Configure the Motherboard” on page 149.

You also need to confirm the BIOS options using the BIOS setup utility procedure. The BIOS setup procedure is described in “To Confirm or Set the BIOS Options” on page 151.

To Identify the Motherboard Installed

Confirm the splash screen is displayed in the beginning of the boot process as shown in Figure 4-43.

Configure the Motherboard

There is a jumper on the A20 digital motherboard that must be configured to the correct setting. Confirm that the jumper setting is “Normal” as shown in Figure 4-43.

Figure 4-43 A20 digital motherboard jumpers location and settings

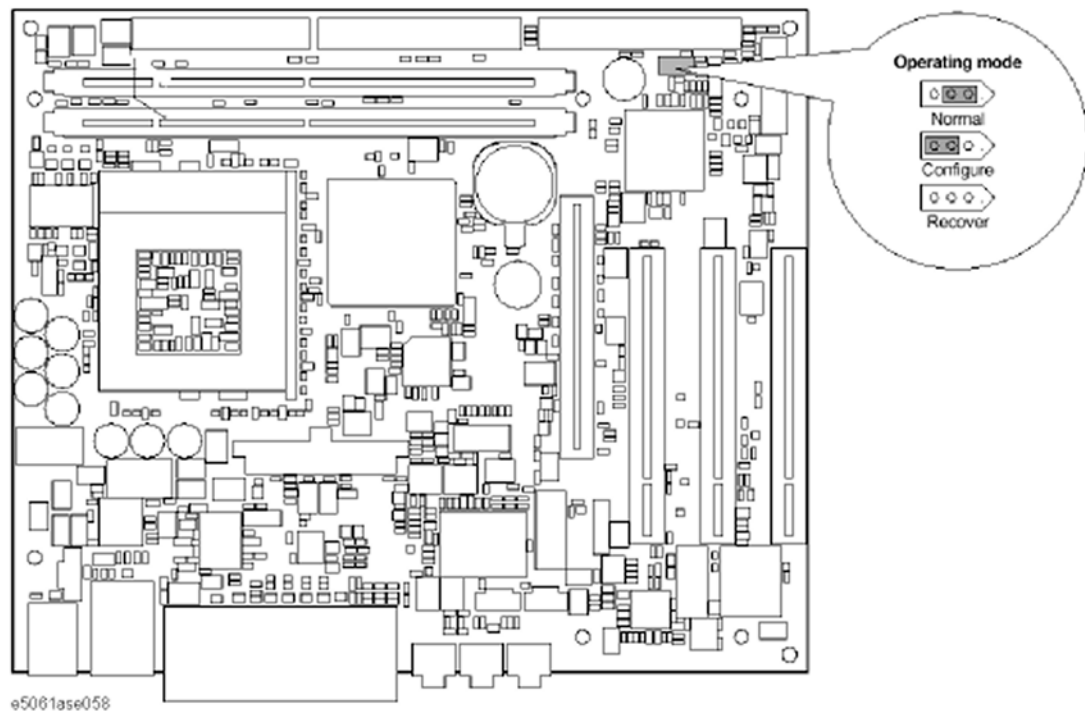

Testing DRAM on the Motherboard

When the A20 digital motherboard is replaced with a new one, it is advisable to perform the DRAM test before proceeding to the BIOS setup utility procedure. Confirm the DRAM count in accordance with the following procedure.

Troubleshooting

To Configure the A20 Digital Motherboard and BIOS (for serial prefix MY433 and later)

- Step 1.** Connect the external keyboard and mouse to the 4287A rear panel connectors.
- Step 2.** Turn the instrument on. Wait until the 4287A boots up. Do not press any key until the 4287A measurement view appears.
- Step 3.** Press **[System]** key on the front panel.
- Step 4.** Click **Misc Setup** in the softkey menu.
- Step 5.** Click **Control Panel...** in the softkey menu.
- Step 6.** Scroll the function viewer to find "System" icon and double-click "System". This opens "System Properties" window as shown in Figure 4-44.

Figure 4-44

System Properties window

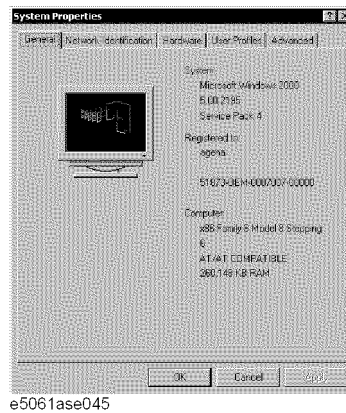

- Step 7.** Verify that "260,148 KB RAM" is displayed in the Computer profile as shown in Figure 4-44. If it is not correct, the A20 board is faulty.
- Step 8.** Click "OK" button to close the window.
- Step 9.** Turn the 4287A off before proceeding to the next step "To Confirm or Set the BIOS Options".

To Configure the A20 Digital Motherboard and BIOS (for serial prefix MY433 and later)

To Confirm or Set the BIOS Options

BIOS is the PC's built-in program describing the standard procedure of basic inputs and outputs for the system hardware. BIOS involves the system BIOS, start-up program and BIOS setup utility. The 4287A starts up first with the BIOS when the power is turned on. Use the following procedure to confirm or set the BIOS options, known as the BIOS setup utility.

Run the BIOS setup utility

Use the external keyboard to select and set various options in the BIOS setup utility. Do not operate the 4287A front panel until you exit the BIOS option setup procedure.









- Procedure**
- Step 1.** Connect the external keyboard to the 4287A rear panel connector.
 - Step 2.** Turn the instrument on.
 - Step 3.** Press F2 key as soon as the splash screen as shown in Figure 4-45 is displayed. Wait a few seconds until the message "Enter CURRENT Password:" appears.
 - Step 4.** Press  key (The LED in the key lights.)
 - Step 5.** Enter password "kid" and press . Then BIOS setup utility main menu is displayed as shown in Figure 4-45.

Figure 4-45 BIOS setup utility main menu

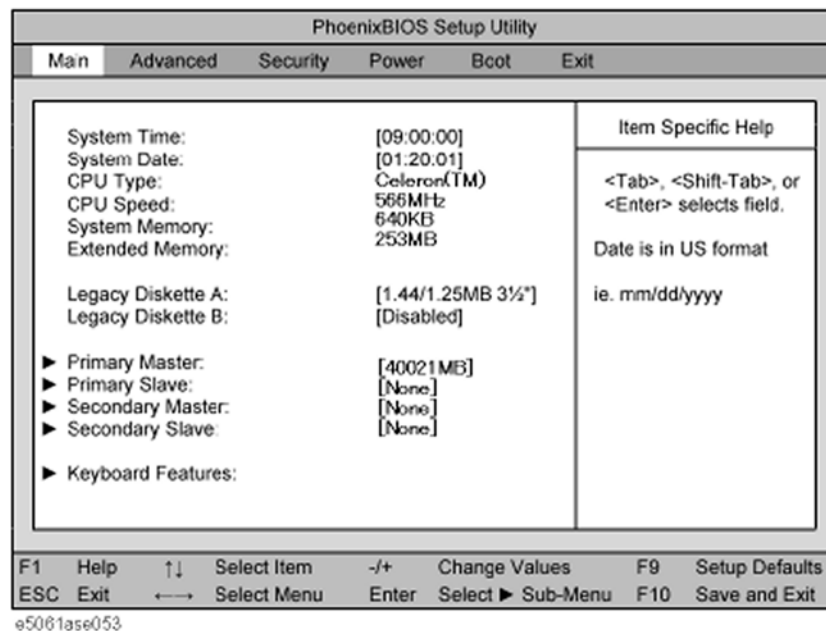

- Step 6.** The BIOS setup utility has primary menus, most of which have sub-menus. Brief descriptions and reference pages for these menus are provided in Table 4-12. The details of the BIOS option settings in each menu and sub-menus are described on the page listed in the table.
- Step 7.** Select a desired menu using   keys. Select a item in the menu or sub-menu window using   keys. To perform an operation, use  key.

NOTE If you want to quit the BIOS option setting and exit the BIOS setup utility without saving changes in the setup, select "Exit Discarding Changes" and press **Enter** key at the Exit Menu.

Table 4-12 BIOS setup utility primary menus and references

Menu	Options	Ref. page
Main	Product description including processor and memory fitted Date and time IDE disks found and sub-menus for extra configuration	on page 151
Advanced	Start-up display mode (silent-boot etc.) Operating system type (ACPI etc.) Advanced chipset configuration Processor cache control PCI space configuration I/O devices configuration Advanced hard disk drive options System monitoring Version information	on page 153
Security	Passwords and permissions	on page 156
Power	Action after AC-reconnect Power savings modes and timers	on page 156
Boot	Selects device boot order	on page 156
Exit	Save with or without changes Load/save default settings (from flash ROM)	on page 157

Load Setup Defaults

NOTE Perform the following procedure only when the A20 digital motherboard is replaced. Jump to "Advanced Menu" when you check whether the BIOS options are correctly set or not.

Exit menu shown below is displayed by choosing "Exit" using **←** **→** keys and by pressing **Enter** key at the BIOS Setup Utility main menu. Select "Load Setup Default" using **↑** **↓** keys. The dialog box "Setup Confirmation" prompts you to select Y (Yes) or N (No). Press **Y** and **Enter** to load the manufacture Setup Defaults into the BIOS ROM. As a result, almost all of the BIOS options are automatically configured to the optimal settings for the 4287A.

Figure 4-46

Exit menu (for Load Setup Defaults)

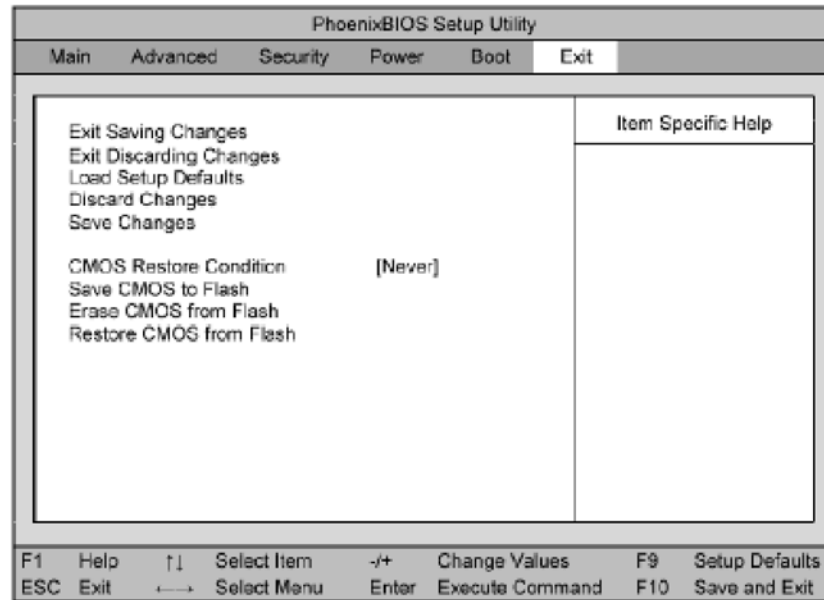

e5081ase057

Advanced Menu

The Advanced Menu shown below is displayed by choosing "Advanced" using keys and by pressing key at the BIOS Setup Utility main menu. Select "Advanced Chipset Control" using keys. The current setup states are displayed as shown in Figure 4-48. If "Video Boot Type" or "Embedded USB Device" or "Embedded USB Device2" is incorrect, select it using keys, and change the setting by pressing keys.

If you want to exit from this page and return to main menu, press key.

Figure 4-47 Advanced Menu

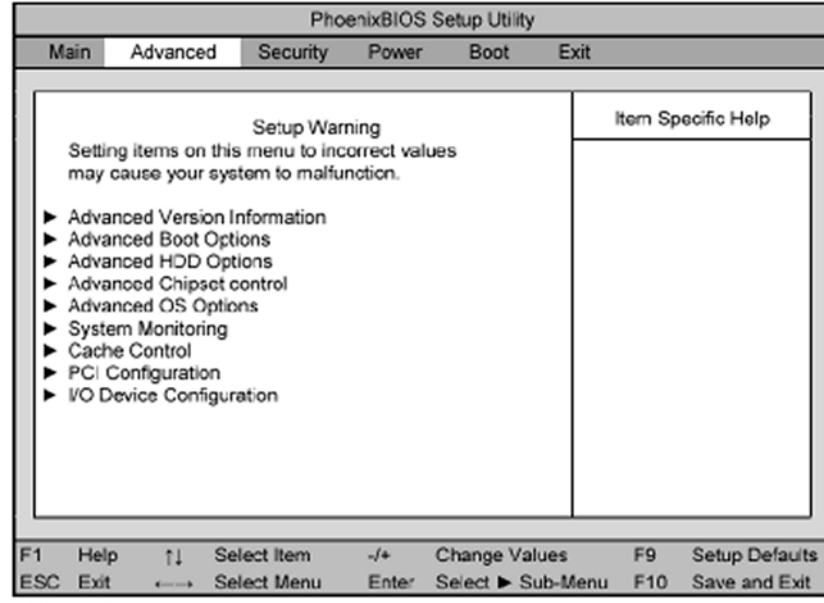
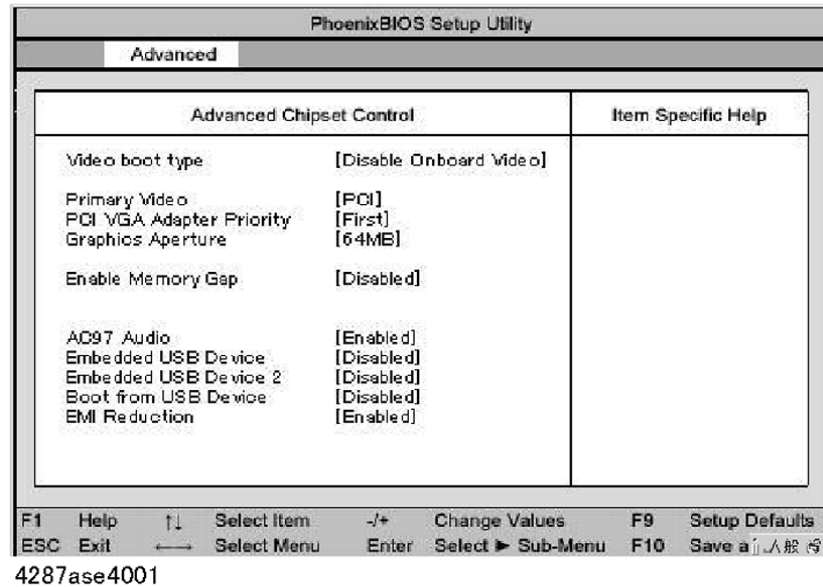

Figure 4-48 Advanced Chipset Control Sub-menu



Next, select “Advanced OS Options” using keys. The current setup states are displayed as shown in Figure 4-49. If “Installed OS” or “Enable ACPI” is incorrect, select it using keys, and change the setting by pressing keys.

If you want to exit from this page and return to main menu, press key.

To Configure the A20 Digital Motherboard and BIOS (for serial prefix MY433 and later)

Figure 4-49 Advanced OS Options Sub-menu

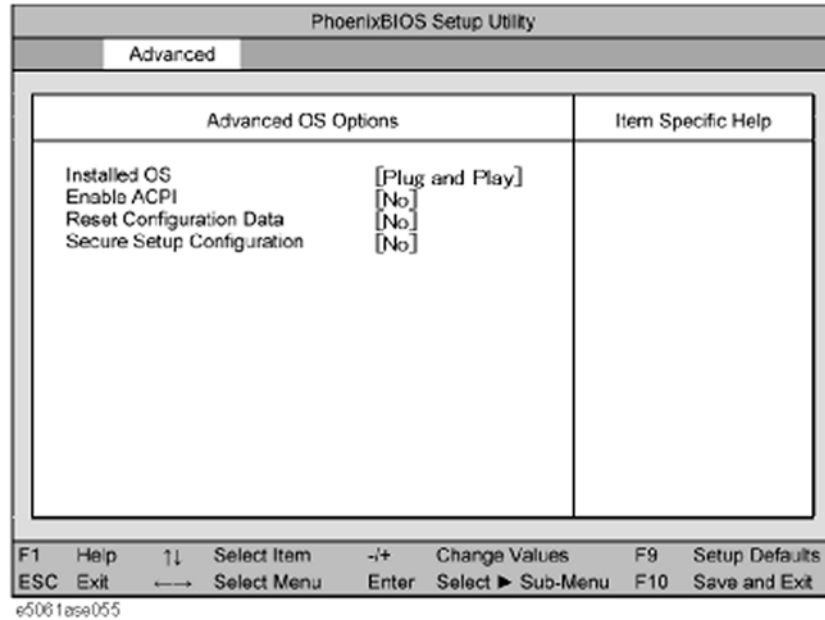

Next, select “I/O Device Configuration” using **↑** **↓** keys. The current setup states are displayed as shown in Figure 4-50. If “Parallel Port” is incorrect, select it using **↑** **↓** keys, and change the setting by pressing **+** **-** keys.

If you want to exit from this page and return to main menu, press **Esc** key.

Figure 4-50 I/O Device onfiguration Sub-menu

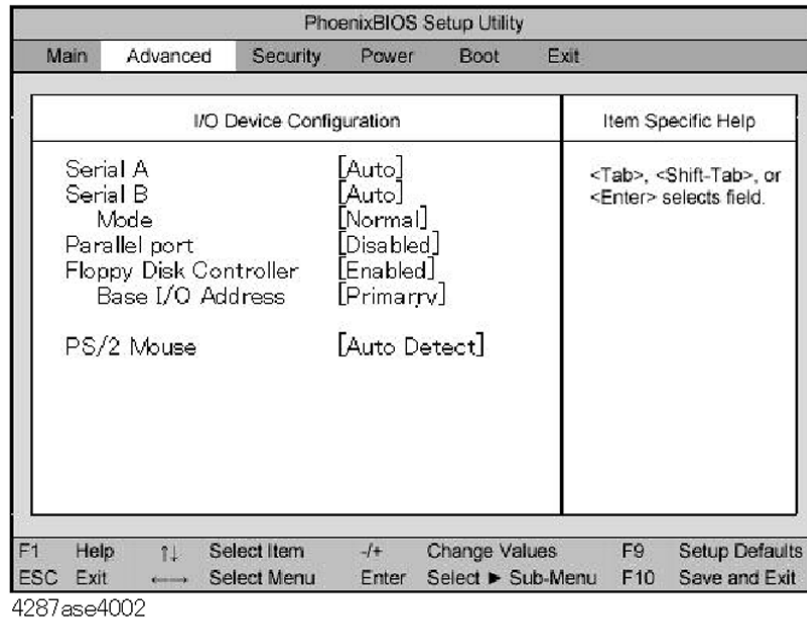

To Configure the A20 Digital Motherboard and BIOS (for serial prefix MY433 and later)

Boot Menu

The Boot Menu shown below is displayed by choosing "Boot" using **←** **→** keys and by pressing **Enter** key at the BIOS Setup Utility main menu. The current setup states are displayed as shown in Figure 4-51. If the setup is incorrect, select it using **↑** **↓** keys, and change the setting by pressing **+** **-** keys.

If you want to exit from this page and return to main menu, press **Esc** key.

Figure 4-51

Boot Menu

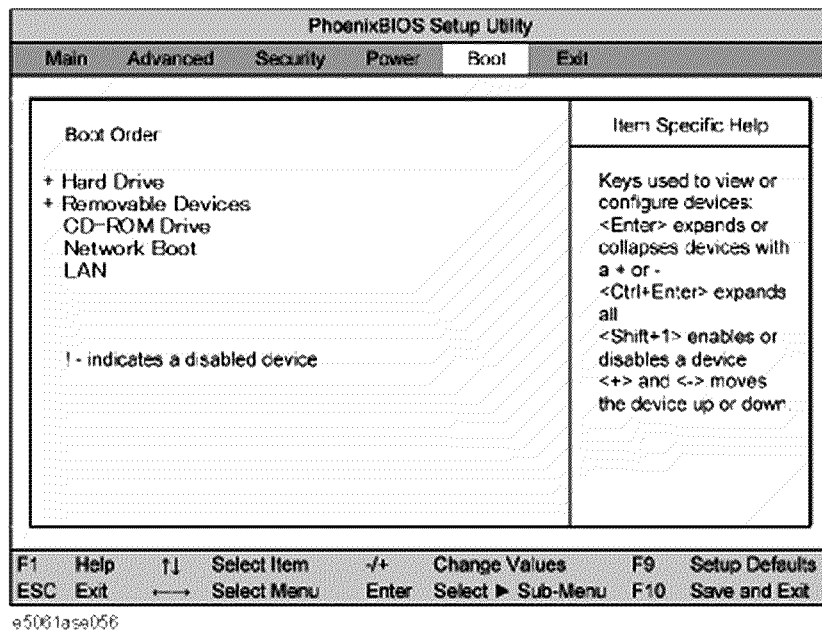

Change Supervisor Password

A password needs to be entered to execute the BIOS setup utility. If a password has not been assigned in the 4287A, set the password using this BIOS setup utility as follows.

- a. Select "Security" using **←** **→** keys at the BIOS Setup Utility main menu and press **Enter** key.
- b. Select "Set Supervisor password" using **↑** **↓** keys and press **Enter** key.
- c. Enter the password of "kid". Never set another password.
- d. Press **Enter** key.
- e. If a message of "New supervisor password installed. Press any key to continue" is displayed, press **Enter** key.

Power Menu

The Power Menu shown below is displayed by choosing "Power" using **←** **→** keys and by pressing **Enter** key at the BIOS Setup Utility main menu. The current setup states are displayed as shown in Figure 4-52. If "After Power Failure" is incorrect, select it using **↑**

To Configure the A20 Digital Motherboard and BIOS (for serial prefix MY433 and later)

↓ keys, and change the setting by pressing + - keys.

If you want to exit from this page and return to main menu, press Esc key.

Figure 4-52

Power Menu

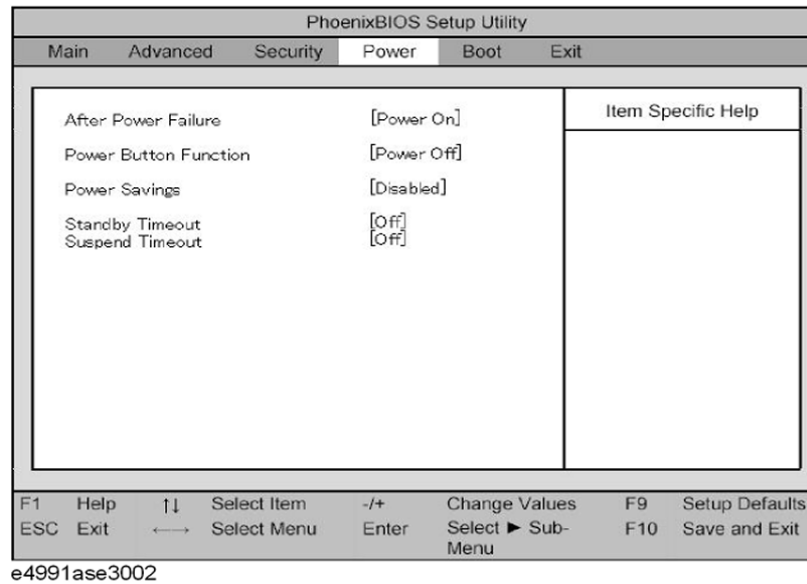

Save & Exit Setup

When you want to change and save a BIOS option, Select "Exit" using ← → keys at the BIOS Setup Utility main menu and press Enter key. Select "Save CMOS to Flash" using ↑ ↓ and press Enter key. Then select "Exit Saving Changes" using ↑ ↓ and press Enter key. A message of "SAVE to CMOS and EXIT (Y/N)?" is displayed. Press Y and Enter keys.

The BIOS setup utility is closed after the current settings are saved.

Exit Without Saving

If you cancel the changes in the BIOS option settings, select "Exit Discarding Change" using ↑ ↓ keys at the Exit Menu and press Enter key.

The BIOS setup utility is closed without saving the current settings.

Troubleshooting

To Configure the A20 Digital Motherboard and BIOS (for serial prefix MY433 and later)

5 Theory of Operation

This chapter provides the theory of operation of the 4287A RF LCR Meter.

Overall Instrument Operation

The 4287A consists of a mainframe, a test head, and a calibration kit, see Figure 5-1. The mainframe includes a source, a receiver, a digital control, and a power supply.

The source generates a stimulus signal in the range 1 MHz to 3 GHz. The stimulus signal goes through the test head, and the test fixture to the device under test (DUT).

The test head senses the voltage across the DUT and the current through the DUT, and applies each signal to the receiver.

The receiver converts the signal to a digital data and forwards it to the digital control.

The calibration kit is used to calibrate the 4287A system. Calibration ensures the impedance measurement accuracy at the test head terminal.

The power supply in the mainframe supplies all necessary power for the 4287A.

Figure 5-1

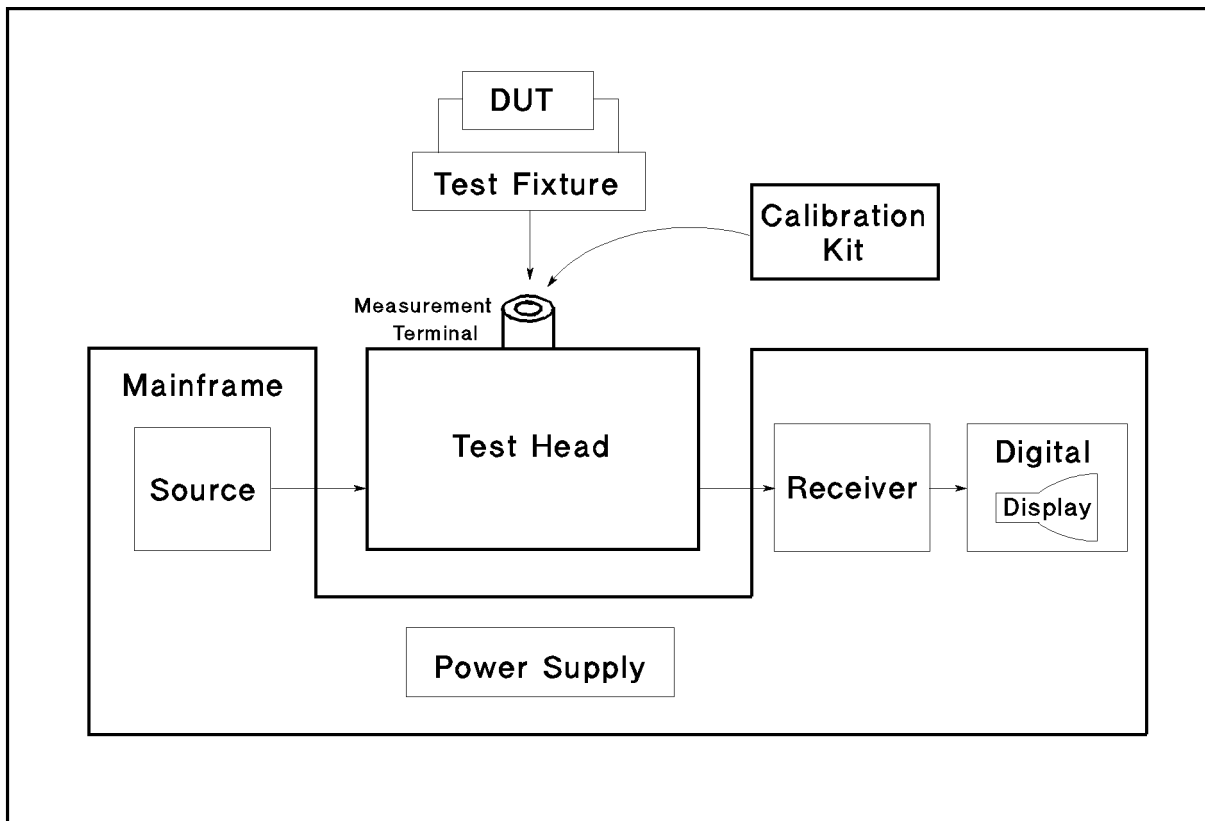

Connection between each assembly in the mainframe is shown in Figure 5-2 system block diagram.

Figure 5-2 System Block Diagram (for serial prefix JP1KG, JP2KG, and MY432)

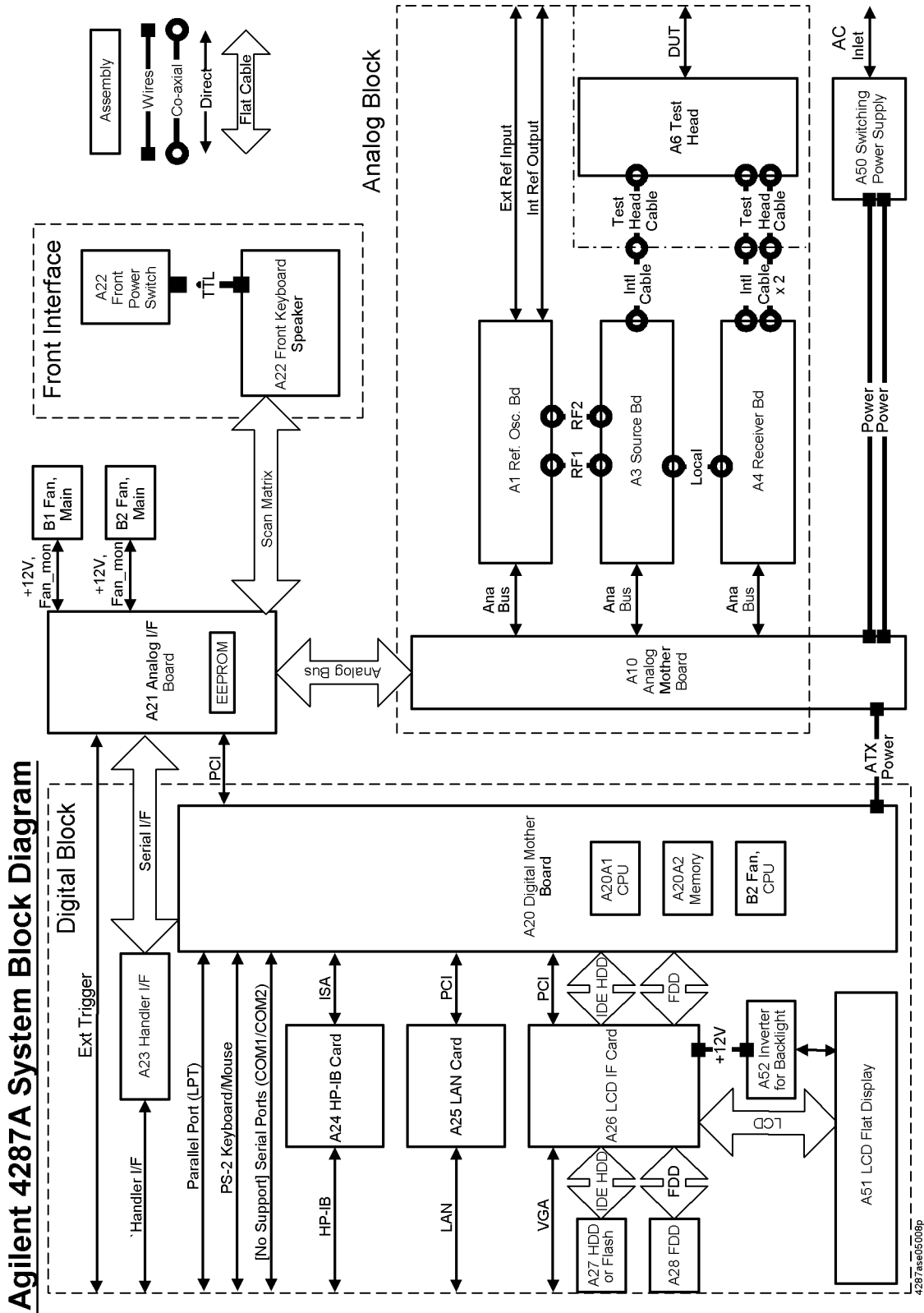
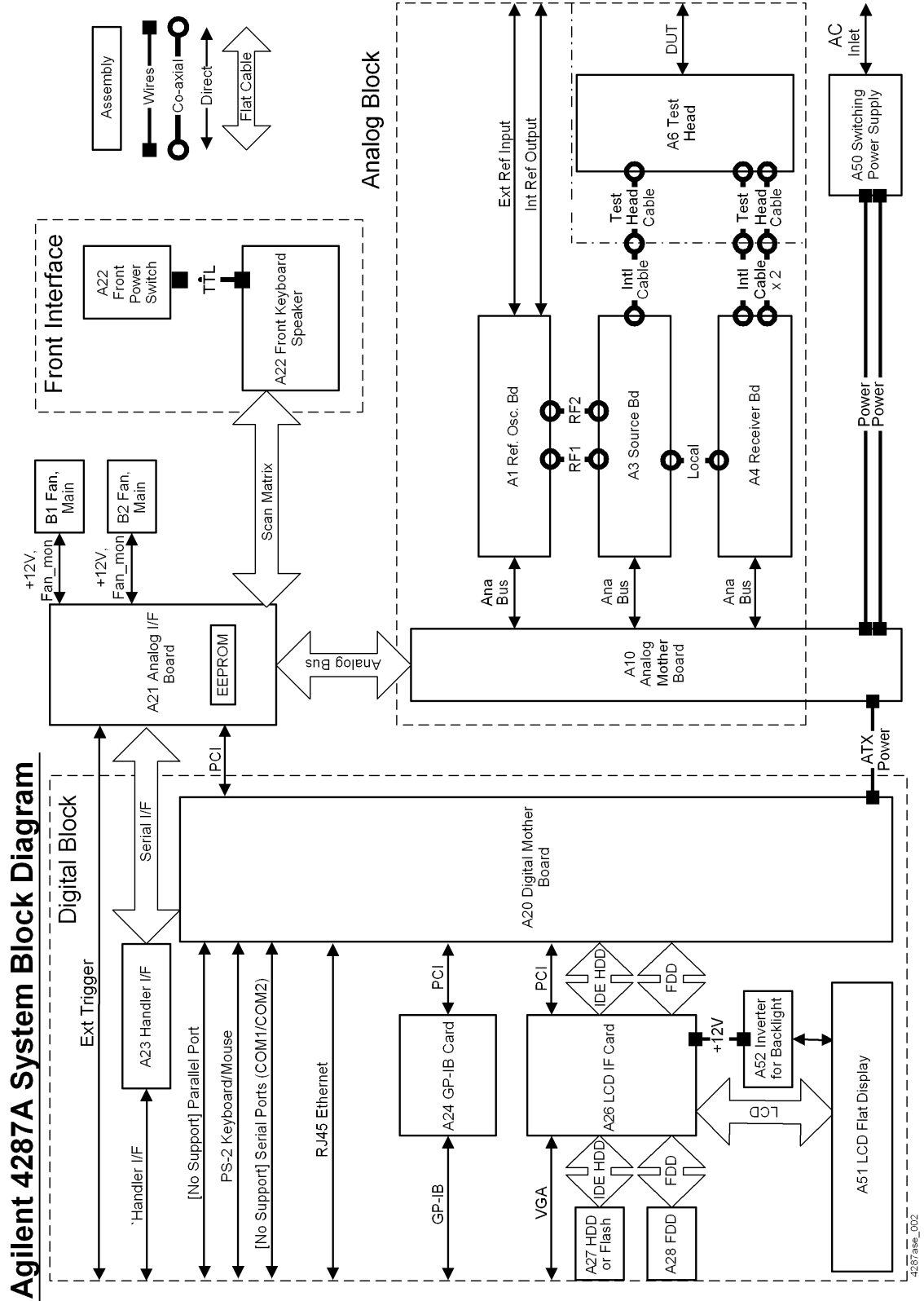

Figure 5-3 System Block Diagram (for serial prefix MY433 and later)



Digital Section

A20 Digital Motherboard (for serial prefix JP1KG, JP2KG, and MY432)

A20 digital motherboard provides basic system control and interface functions for the instrument. It contains a CPU, ROM for BIOS, 64MBytes RAM, keyboard and mouse interfaces, and interfaces to PCI (Peripheral Component Interconnect) and ISA (Industry Standard Architecture) buses.

A20 Digital Motherboard (for serial prefix MY433 and later)

A20 digital motherboard provides basic system control and interface functions for the instrument. It contains a CPU, ROM for BIOS, 256MBytes RAM, keyboard and mouse interfaces, LAN interfaces and interfaces to PCI (Peripheral Component Interconnect) buses.

A21 Analog Interface Board

A21 analog interface board has several functions, an interface function between digital and analog, the other interface functions for A22 front panel keyboard A23 handler interface board, a power control function, and measurement function. The A21 contains PLD (Programmable Logic Device) for interface functions, a BNC connector for external trigger input, DSP (Digital Signal Processor) for post measurement data processing and EEPROM that stores correction constants for adjustment data.

A22 Front Panel Keyboard

A22 front panel keyboard detects users inputs, key inputs and RPG inputs, from the front panel, and transmits them to the A21 analog interface board.

A23 Handler Interface Board

A23 handler interface board interfaces the 4287A to an external handler. The signals of the handler interface are optically isolated.

A24 GPIB Board

A24 GPIB board provides IEEE-488 standard bus services for instrument. The board interfaces the bus to A20 digital motherboard to receive and process GPIB commands.

A25 LAN Interface Board (for serial prefix JP1KG, JP2KG, and MY432)

A25 LAN interface board allows a network interconnect to communicate an external controller or an external server. Protocol is TCP/IP, and it works for 10base-T and 100base-TX.

A26 Display Board

A26 display board controls LCD. The control signal goes through a flat cable, and backlight voltage is supplied through A52 inverter board.

A27 Mass Storage Disk Drive

A27 mass storage disk drive are a 2.5 inches hard disk drive for option 010, or a flash drive for option 011. The drives are used to store the operating system, firmware, and user's measurement data. The drives are mounted with shock-resistance, but be careful for the mechanical handling.

A28 FDD (Floppy Disk Drive)

A28 FDD is a 1.44 MBytes, 3.5 inches, MS-DOS compatible, and it is located on the front panel.

A51 LCD (Liquid Crystal Display)

A51 is an 8.4 TFT color LCD. It consists of display and two backlights. Video signal is provided from A25 Display Board through a flat cable.

High voltage is supplied from A52 Inverter to the LCD's backlights. If the backlights aren't bright, the LCD will be too dark to see the monitor.

A52 Inverter Board

A52 converts voltage to be able to drive LCD's backlight.

Analog Section

The analog group consists of A1 reference osc board, A3 source board, A4 receiver board, A6 test head, and A10 analog motherboard. The A1, A3, and A4 are controlled by A20 digital motherboard through A21 analog interface board and A10 analog motherboard.

Figure 5-4 Analog Block Diagram

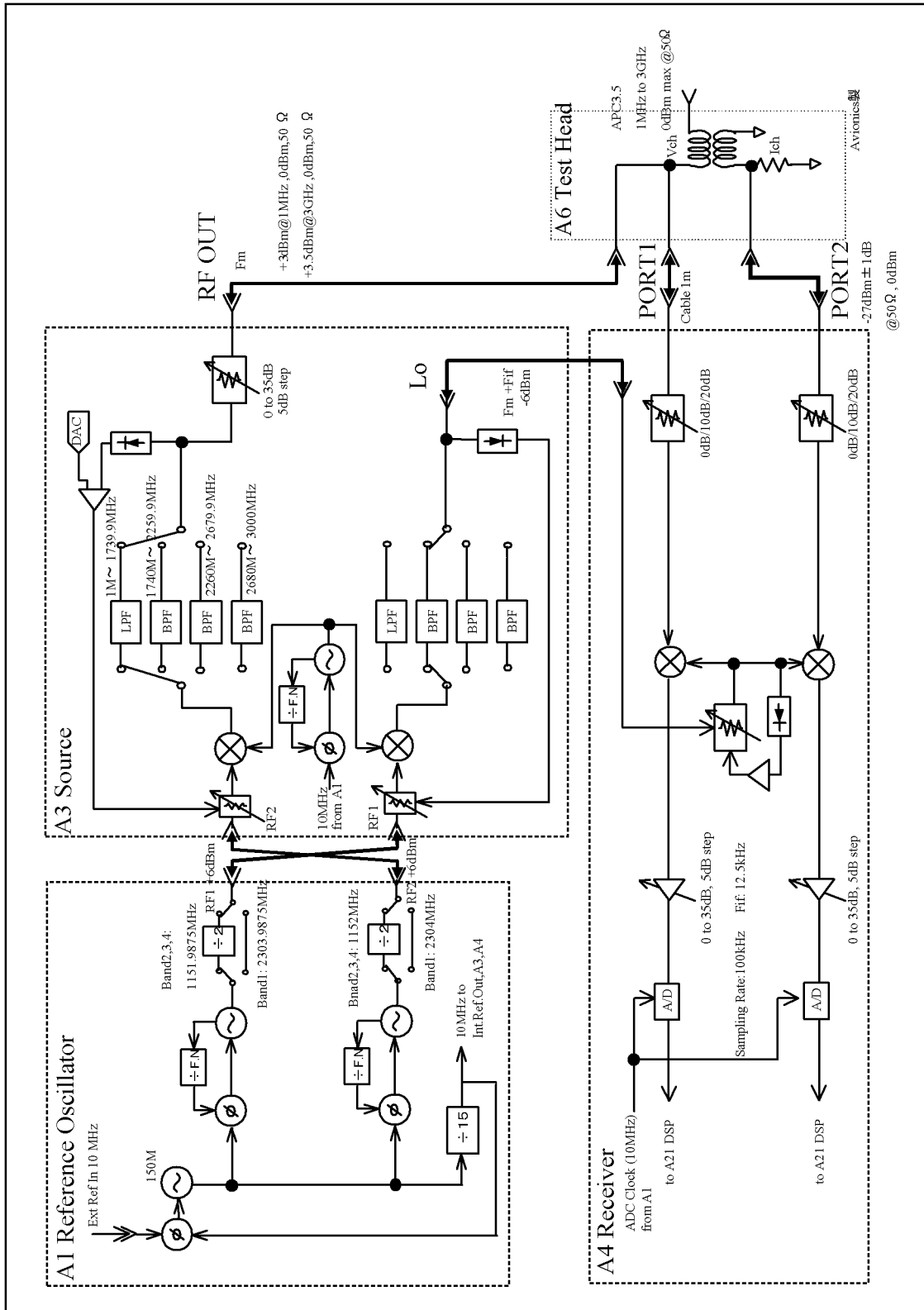

4287ase05007p

A1 Reference Oscillator Board

A1 reference oscillator board provides reference frequencies of RF1, RF2, Int Ref Out, and 10 MHz reference for A3 and A4.

An oscillator in A1 creates 150 MHz reference signal. If nothing is connected to Ext Ref In connector on the rear panel, it provides frequency created by own VCXO (Voltage Controlled Crystal Oscillator), but if external 10 MHz signal is supplied to the Ext Ref In, frequency and phase are locked to the external signal in a PLL (Phase Lock Loop) circuit.

Then the 150 MHz signal is converted to RF1 and RF2 in the fractional N oscillators that contains PLLs. If one of control voltage for PLLs is out of limit, “PLL Unlock” notification is displayed.

The RF1 is supplied to A3 source board for local signal that will be supplied to A4 finally, and its frequency depends on measurement frequency listed below. The signal level of the RF1 is +6 dBm typically. The RF2 is supplied to A3 for measurement signal that outputs from RF OUT port. The signal level of the RF2 is +6 dBm typically. The difference between RF1 and RF2 is always 12.5 kHz that is frequency of IF signal.

Table 5-1

RF1 and RF2 Frequencies for Each Bands

	Measurement Frequency	RF1	RF2
Band1	1 MHz – 1739.9 MHz	2303.9875 MHz	2304 MHz
Band2	1740 MHz – 2259.9 MHz	1151.9875 MHz	1152 MHz
Band3	2260 MHz – 2679.9 MHz	1151.9875 MHz	1152 MHz
Band4	2680 MHz – 3000 MHz	1151.9875 MHz	1152 MHz

The created 150 MHz signal is also converted to 10 MHz signal, and it is supplied to Int Ref Out BNC connector on the rear panel directly. And it is supplied to A3 and A4 for reference frequency through A10 analog motherboard.

A3 Source Board

A3 source board supplies measurement signal from RF OUT port to A6 test head, and local signal to A4 receiver board.

Frequency from a VCO (Voltage Controlled Oscillator) varies from 2305 MHz to 4152 MHz, and it is converted to measurement frequency by mixing RF2 signal from A1. After the conversion, the signal is filtered to cut spurious by BPF (Band Pass Filter) or LPF (Low Pass Filter).

Table 5-2

Frequencies for Each Bands

	Measurement Frequency	VCO Frequency
Band1	1 MHz – 1739.9 MHz	2305 MHz – 4043.9 MHz
Band2	1740 MHz – 2259.9 MHz	2892 MHz – 3411.9 MHz
Band3	2260 MHz – 2679.9 MHz	3412 MHz – 3831.9 MHz
Band4	2680 MHz – 3000 MHz	3832 MHz – 4152 MHz

The filtered signal goes through a variable attenuator that changes from 0 dB to 35 dB by 5 dB step, and is output from RF Out port. Attenuation value depends on the output power setting listed below.

Table 5-3

Output Attenuator

Nominal Setting of Output Power Level	Output Attenuator on A3
-7.9 dBm ~ +1 dBm	0 dB
-12.9 dBm ~ -8 dBm	5 dB
-17.9 dBm ~ -13 dBm	10 dB
-22.9 dBm ~ -18 dBm	15 dB
-27.9 dBm ~ -23 dBm	20 dB
-32.9 dBm ~ -28 dBm	25 dB
-37.9 dBm ~ -33 dBm	30 dB
-40 dBm ~ -38 dBm	35 dB

The VCO signal is also converted to the LO (Local) signal and supplied to A4 receiver board. Frequency of LO is just greater than 12.5 kHz.

For the DC resistance measurement, voltage source and sense circuit is on A3 source board. The sensed voltage goes through A10 analog motherboard to ADC on A4 for digitizing the voltage.

A4 Receiver Board

A4 receiver board receives the RF signal from the A6 test head through PORT1 and PORT2, and converts the signal to digital data. The receiver has two passes to measure voltage and current.

Frequency of the RF signal is directly converted to IF, 12.5 kHz, in mixers.

The receiver converts the RF signal level in input attenuators to have best SNR (signal to noise ratio). The attenuations depends on the output power setting listed below.

Table 5-4

Input Attenuator

Nominal Setting of Output Power Level	Input Attenuator on A4
-12.9 dBm ~ +1 dBm	20 dB
-22.9 dBm ~ -13 dBm	10 dB
-40 dBm ~ -23 dBm	0 dB

And the signal level is converted in the variable amplifier. The amplifier control the level to be suitable input level for ADC (analog to digital converter). Gain of the amplifier is decided automatically.

The digitized data at ADC goes through A10 analog motherboard to the DSP on A21

analog interface board.

A6 Test Head Board

A6 test head receives the stimulus signal from the A3 source board through RFOUT port and test cable, and applies it to the DUT (device under test). At the same time, the test head sense two signals that represent the voltage across the DUT and the current through the DUT.

A10 Analog Motherboard

A10 analog motherboard connects A1, A3, and A4 to A21 analog interface board.

6 **Replaceable Parts**

This chapter contains information for ordering replacement parts for the 4287A RF LCR Meter.

Ordering Information

To order part listed in the replaceable part lists, quote the Agilent part number (with a check digit), indicate the quantity required, and address the order to the nearest Agilent office. The check digit will ensure accurate and timely processing of the order.

To order a part not listed in the replaceable part table, include the instrument model number, the description and function of the part, and the quantity of parts required. Address the order to the nearest Agilent office.

Direct Mail Order System

Within the USA, Agilent can supply parts through a direct mail order system. There are several advantages to this system:

- Direct ordering and shipping from the Agilent Parts Center in Mountain View, California.
- No maximum or minimum on any mail order (there is a minimum order amount for parts ordered through a local Agilent office when the orders require billing and invoicing)
- Prepaid transportation (there is a small handling charge for each order).
- No invoices.

In order for Agilent to provide these advantages, please send a check or money order with each order.

Mail order forms and specific ordering information are available through your local Agilent sales office. Addresses and telephone numbers are located in a separate document shipped with the manuals.

Exchange Assemblies

Under the rebuilt-exchange assembly program, certain factory-repaired and tested assemblies are available on a trade-in basis. These assemblies are offered at a lower cost than a new assembly, but meet all factory specifications required of a new assembly.

The defective assembly must be returned for credit under the terms of the rebuilt-exchange assembly program. Any spare assembly stock desired should be ordered using the new assembly part number.

Replaceable Parts List (for serial prefix JP1KG, JP2KG, and MY432)

Power Cables and Plug Configurations

For details of the power cables and plug configurations, refer to Appendix E, “Power Requirement,” on page 281.

Top View (Measure Assembly)

Figure 6-1 Top View (Measure Assembly)

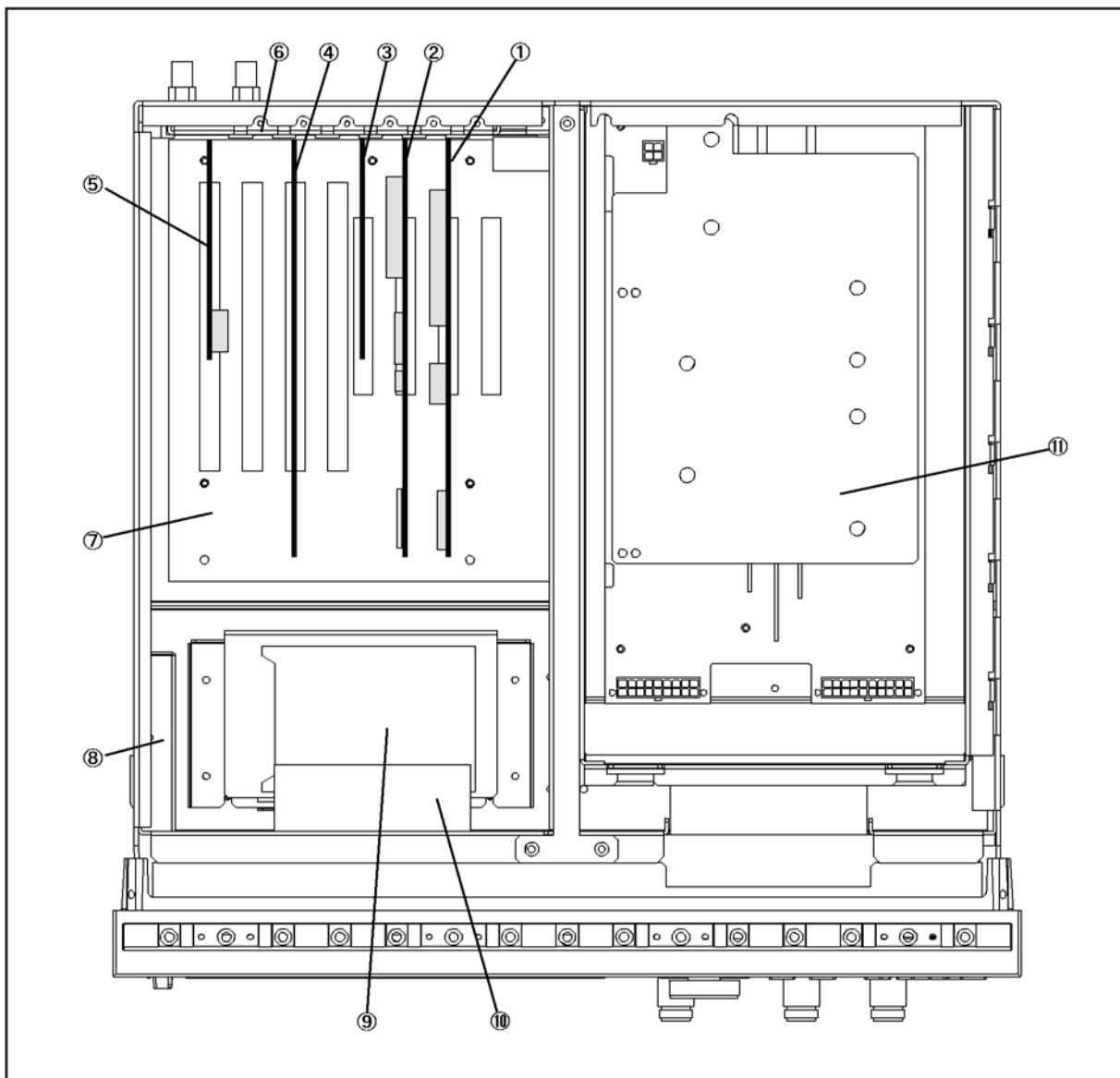

4287ase06003

Table 6-1 Top View (Measure Assembly)

Ref. Desig.	Agilent Part Number	C/D	Qty.	Description
1	04287-66521	7	1	A21 ANALOG INTERFACE BOARD
	1818-6491	1	1	IC, EEPROM*1
	0515-0430	3	1	SCREW M3
2	54810-66525		1	A26 DISPLAY BOARD
	04287-87101	3	1	LABEL
	0515-0430	3	1	SCREW M3
3	1150-7769	8	1	A25 LAN BOARD
	0515-0430	3	1	SCREW M3
4	82341C #002	8	1	A24 GPIB BOARD
	0515-0430	3	1	SCREW M3
5	04287-66523	9	1	A23 HANDLER INTERFACE BOARD
6	04287-01210	5	2	SLOT COVER
	0515-0430	3	2	SCREW M3
7	04287-61020	1	1	A20 ATX DIGITAL MOTHER BOARD
	0515-1250	7	7	SCREW M3X0.5
8	0950-2782	4	1	A28 FLOPPY DISK DRIVE
	04287-01203	6	1	FDD HOLDER
	0515-1056	1	3	SCREW
	0515-1550	0	4	SCREW M3-L 8 P-H
9	See Table 6-11		1	A27 Mass Storage Disk Drive Assembly
	0515-1550	0	4	SCREW M3-L 8 P-H
10	04287-61011	8	1	FAN ASSY
	0515-1666	9	4	SCREW M4X35 POZI
11	See Table 6-12		1	A50 Power Supply Assembly

*1. Included in the analog Interface board.

Top View (Cables & Other Parts)

Figure 6-2 Top View (Cables & Other Parts)

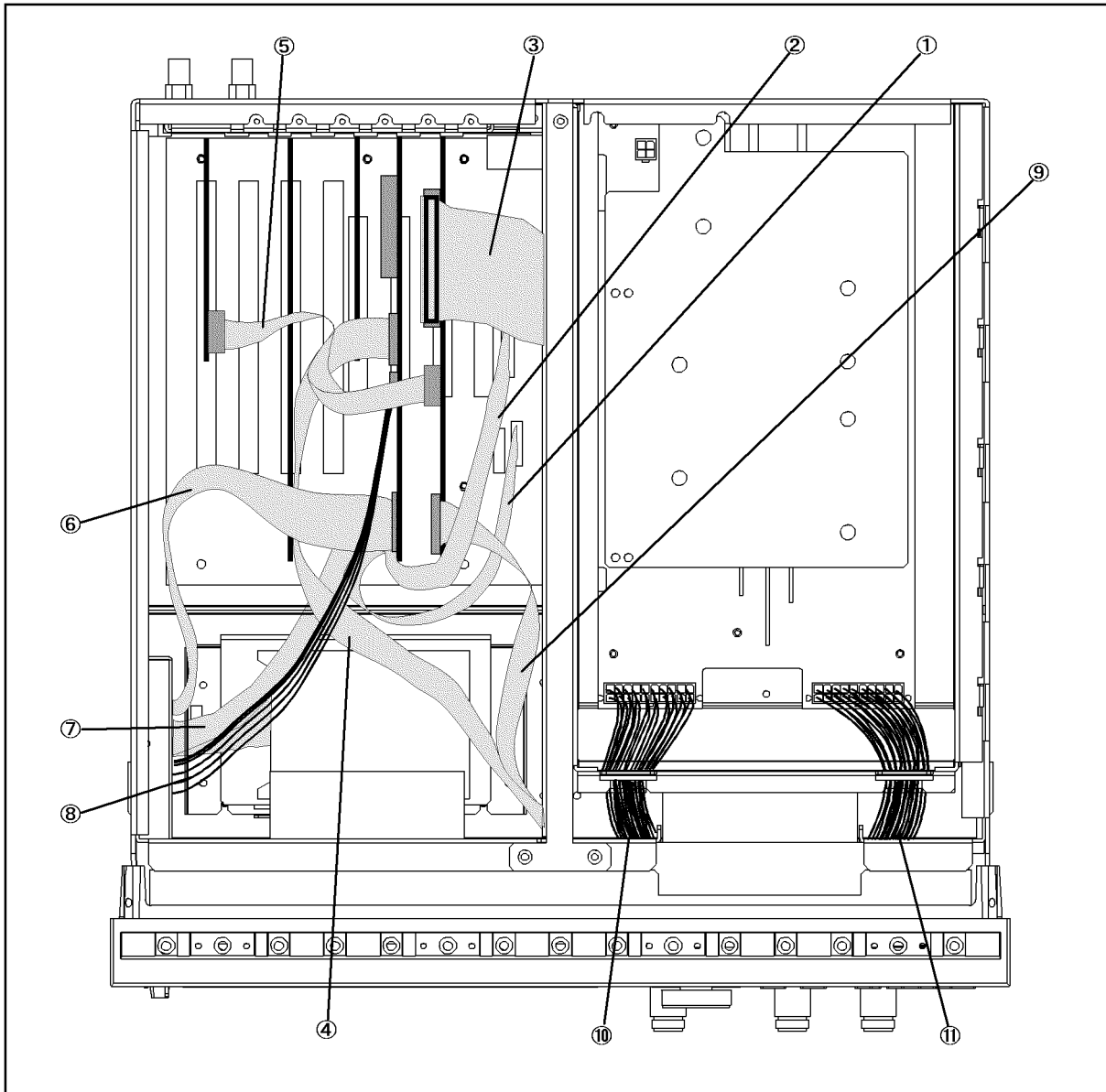

4287ase06017

Table 6-2 Top View (Cables)

Ref. Desig.	Agilent Part Number	C/D	Qty.	Description
1	54801-61611	5	1	FLAT CABLE ASSY
2	54801-61610	4	1	FLAT CABLE ASSY
3	04396-61707	3	1	CABLE ASSY
4	04287-61607	0	1	FLAT CABLE
5	04287-61608	1	1	FLAT CABLE ASSY
6	E5100-61661	1	1	CABLE FLAT 26PIN
7	54801-61636	4	1	FLAT CABLE ASSY
8	54801-61635	3	1	WIRE ASSY
9	04287-61609	2	1	FLAT CABLE ASSY
10	04287-61632	1	1	WIRE ASSY
11	04287-61633	2	1	WIRE ASSY

Top View (Miscellaneous Parts)

Figure 6-3

Top View (Miscellaneous Parts)

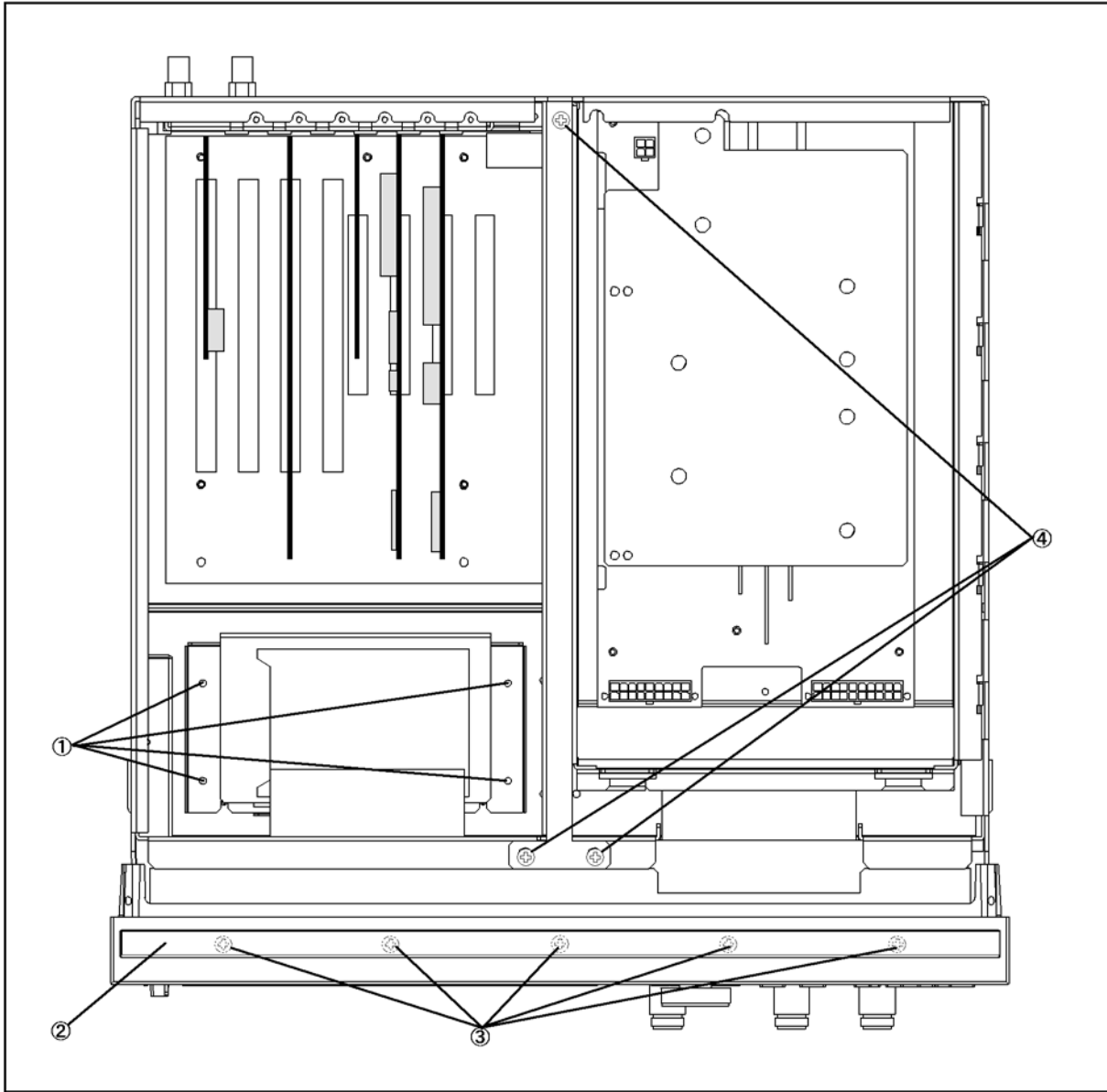

4287ase06010

Table 6-3 Top View (Under Power Supply)

Ref. Desig.	Agilent Part Number	C/D	Qty.	Description
1	0515-1550	0	4	SCREW M3-L 8 P-H
2	5041-9176	2	1	TRIM STRIP
3	0515-0889	6	5	SCREW-MACH M3.5X.6
	0515-0889	6	6	SCREW-MACH M3.5X.6 (Bottom Side)
4	0515-0914	8	3	SCREW-MACH M3X0.5

Top View (Under Power Supply)

Figure 6-4

Top View (Under Power Supply)

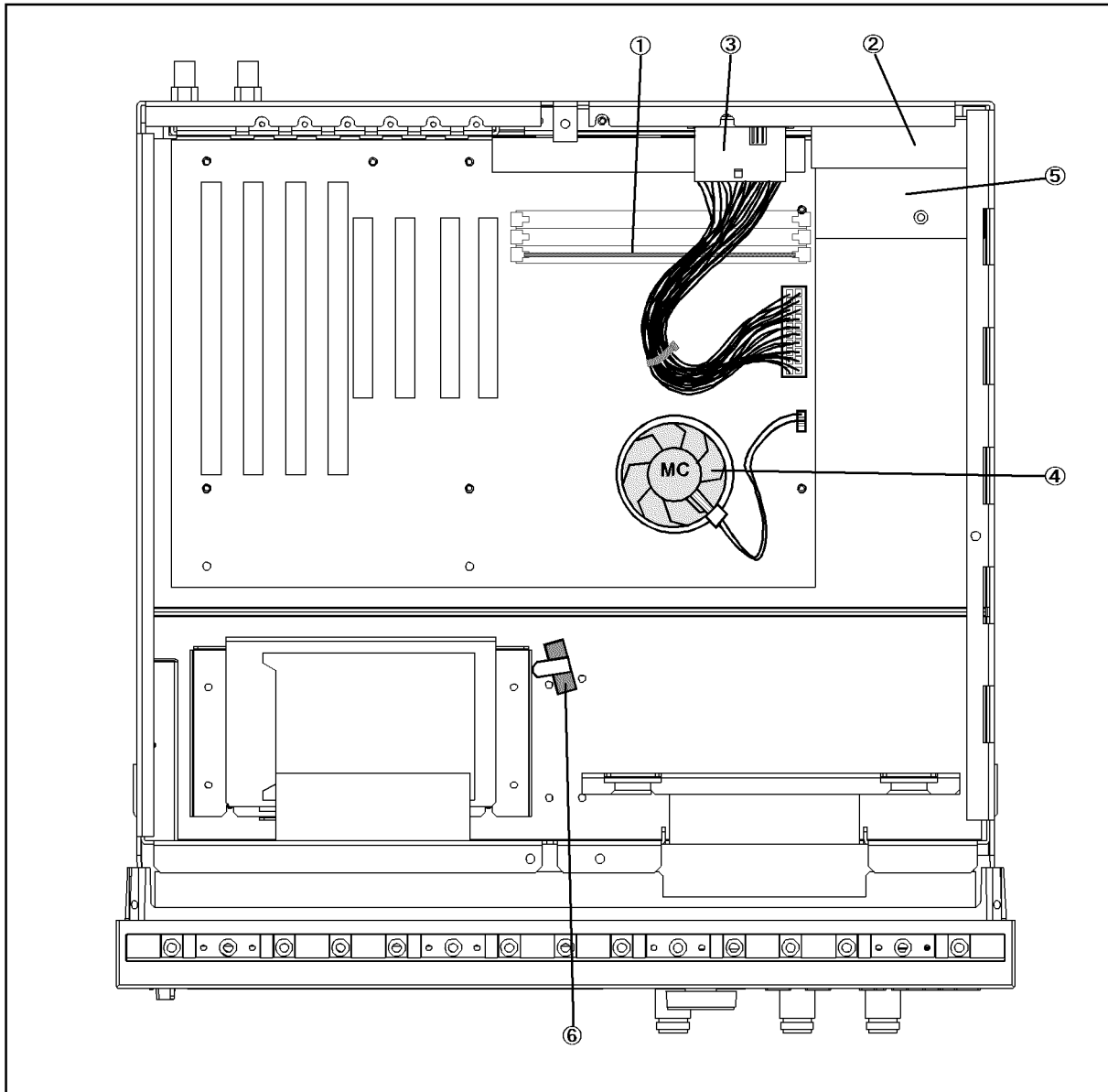

4287ase06016

Table 6-4 Top View (Under Power Supply)

Ref. Desig.	Agilent Part Number	C/D	Qty.	Description
1	1818-8149		1	DIMM64MB
	1400-0249	0	5	CABLE TIE
2	04287-66510	4	1	ANALOG MOTHER
	0515-1550	0	10	SCREW M3-L 8 P-H
3	04287-61631	0	1	WIRE ASSY
4	1821-3660	7	1	CPU 233 MHz
	3160-0938	6	1	FAN
	5183-4063	6	1	THERMAL CMD
	5184-4049	0	1	CLAMP
5	04287-61622	9	1	WIRE ASSY
	04287-01213	8	1	COVER
	0515-1550	0	1	SCREW M3-L 8 P-H
	0515-0914	8	3	SCREW-MACH M3X0.5
6	1400-1334	6	1	CLAMP CABLE

Front View (Analog Boards and Semi Rigid Cables)

Figure 6-5

Front View (Analog Boards and Semi Rigid Cables)

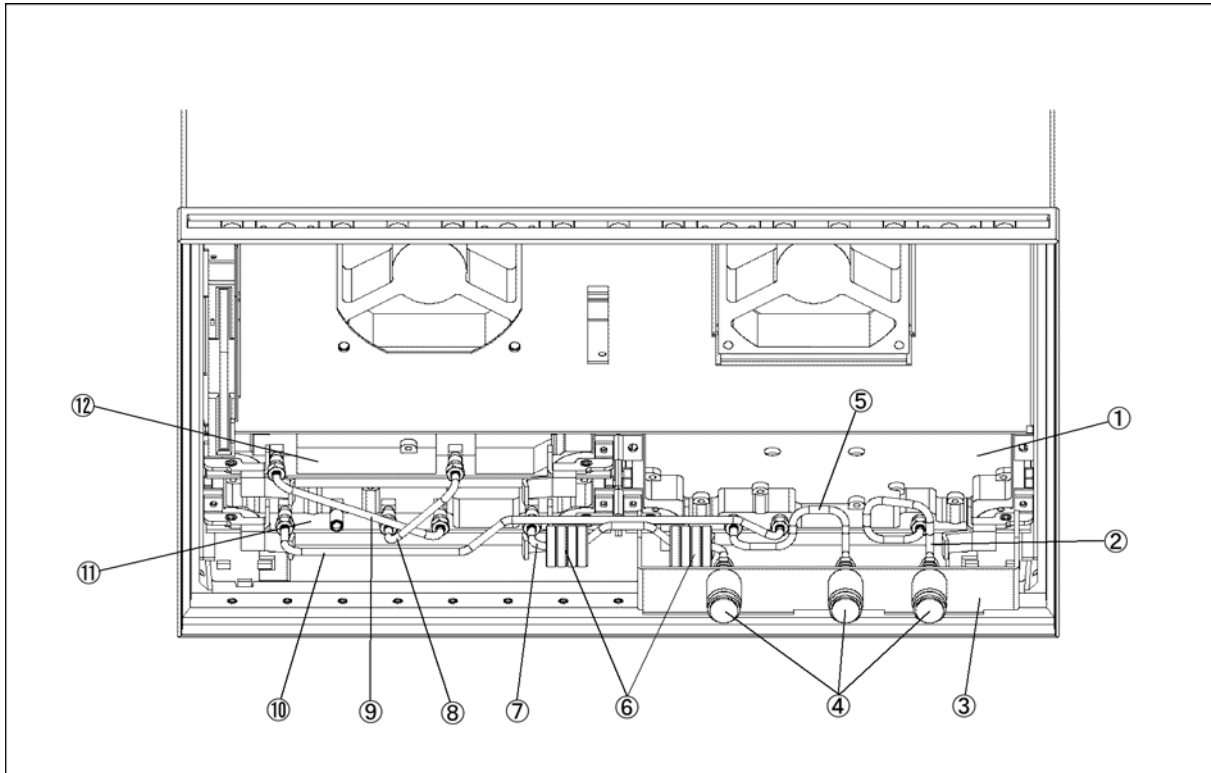

4287ase06005

Table 6-5 Front View (Analog Boards and Semi Rigid Cables)

Ref. Desig.	Agilent Part Number	C/D	Qty.	Description
1	04287-66554	8	1	A4 RECEIVER BOARD
	04287-69554	4	1	A4 RECEIVER BOARD (Exchange)
	0515-1550	0	2	SCREW M3-L 8 P-H
2	04287-61601	4	1	RF CABLE ASSY
3	04287-01201	4	1	BRACKET CONNECT
	0515-0924	0	4	SCREW-MACH M3X0.5
	5061-5386	0	3	CONN TP N (UTIL)
4	2950-0132	6	3	NUT-HEX-DUB-CHAM
	2190-0104	0	3	WSHR-LK INTL T
	04287-61603	6	1	RF CABLE ASSY SRGD
6	9170-1468	6	8	CORE-TROID
	1400-0249	0	2	CABLE TIE
7	04287-61604	7	1	RF CABLE ASSY
8	04287-61605	8	1	RF CABLE ASSY
9	04287-61606	9	1	RF CABLE ASSY
10	04287-61602	5	1	RF CABLE ASSY
11	04287-66553	7	1	A3 SOURCE BOARD
	04287-69553	3	1	A3 SOURCE BOARD (Exchange)
	0515-1550	0	2	SCREW M3-L 8 P-H
12	04287-66511	5	1	A1 REFERENCE OSCILLATOR
	04287-69511	1	1	A1 REFERENCE OSCILLATOR (Exchange)
	0515-1550	0	2	SCREW M3-L 8 P-H

Front Panel

Figure 6-6 Front Panel

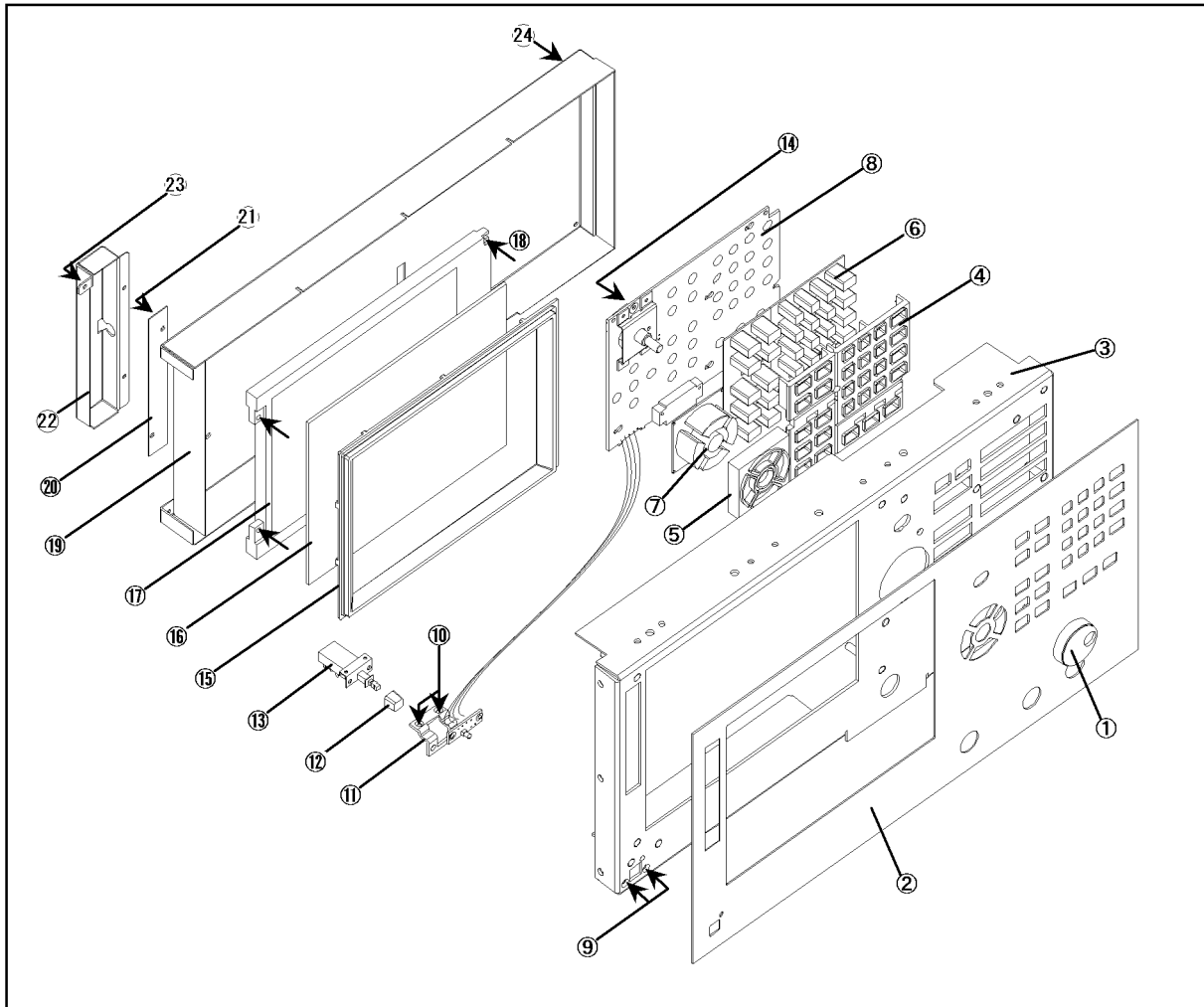

4287ase06009

Table 6-6 Front Panel

Ref. Desig.	Agilent Part Number	C/D	Qty.	Description
1	5182-7594	2	1	KNOB
2	04287-00201	2	1	FRONT PANEL
3	04287-00202	3	1	SUB PANEL
4	E5100-40001	9	1	FRONT BEZEL
5	04287-40003	6	1	GUIDE FOR CURSOR KEY
6	04287-25001	2	1	RUBBER KEY
7	04287-25002	3	1	RUBBER KEY (CURSOR)
8	04287-66522	8	1	FRONT KEYBOARD
9	0515-0914	8	2	SCREW-MACH M3X0.5
10	0515-0999	9	2	SCREW M2.5X0.45 L=6 FL
11	04287-01212	7	1	BRACKET SW
12	5041-0564	4	1	KEY CAP
13	04287-61901	7	1	WIRE ASSY WITH SWITCH
14	0515-1550	0	1	SCREW M3-L 8 P-H
15	04287-40001	4	1	FRONT BEZEL
16	04287-25003	4	1	OPTICAL FILTER
17	2090-0396	0	1	LCD-DISPLAY
	04287-25004	5	1	GASKET
18	0515-1550	0	4	SCREW M3-L 8 P-H
19	04287-00601	6	1	COVER SHIELD
20	0950-3235	4	1	INVERTER
21	0515-1550	0	2	SCREW M3-L 8 P-H
22	04287-01215	0	1	ANGLE
23	0515-1550	0	3	SCREW M3-L 8 P-H
24	0515-1550	0	6	SCREW M3-L 8 P-H

Front Panel (Back Side)

Figure 6-7 Front Panel (Back Side)

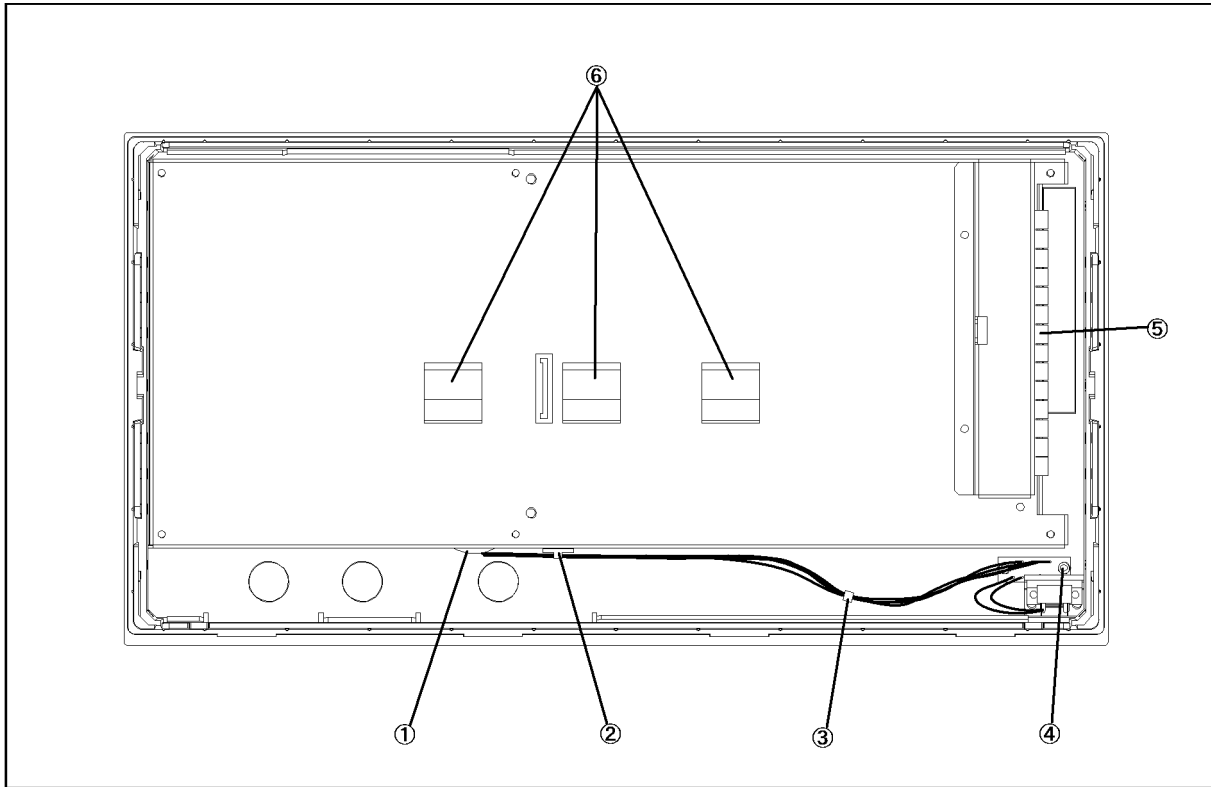

4287ase06015

Table 6-7 Front View (Analog Boards and Semi Rigid Cables)

Ref. Desig.	Agilent Part Number	C/D	Qty.	Description
1	0400-0010	2	1	ROUND GROMET
2	1400-1334	6	1	CABLE CLAMP
3	1400-0249	0	1	CABLE TIE
4	0515-1550	0	2	SCREW M3-L 8 P-H
5	0363-0170	5	9 cm	RFI GASKET
6	1400-0611	0	3	CABLE CLAMP

Rear View

Figure 6-8

Rear View

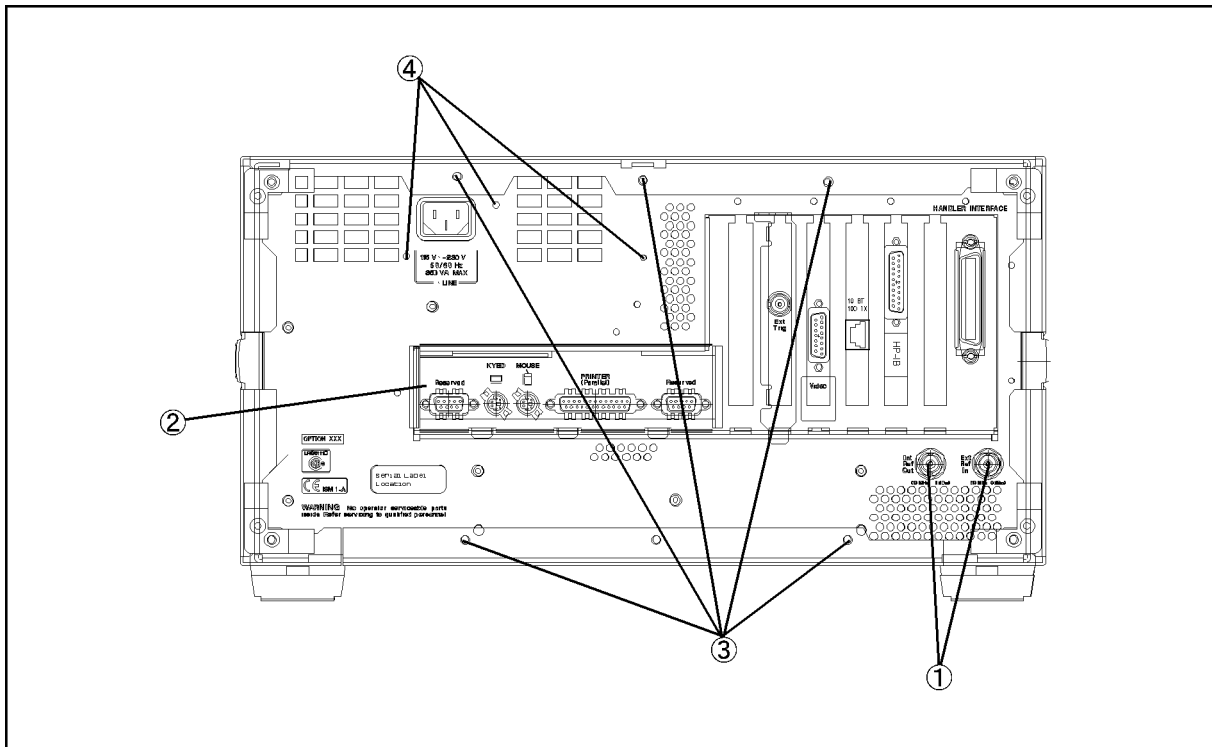

4287ase06007

Table 6-8 Rear View

Ref. Desig.	Agilent Part Number	C/D	Qty.	Description
1	2950-0054	1	2	NUT-HEX-DBL-CHAM
	2190-0054	9	2	WSHR-LK INTL T
2	04287-01205	8	1	REAR COVER I/O
3	0515-1232	5	6	SCREW-MACH M3.5
4	0515-1550	0	3	SCREW M3-L 8 P-H

Side View

Figure 6-9

Side View

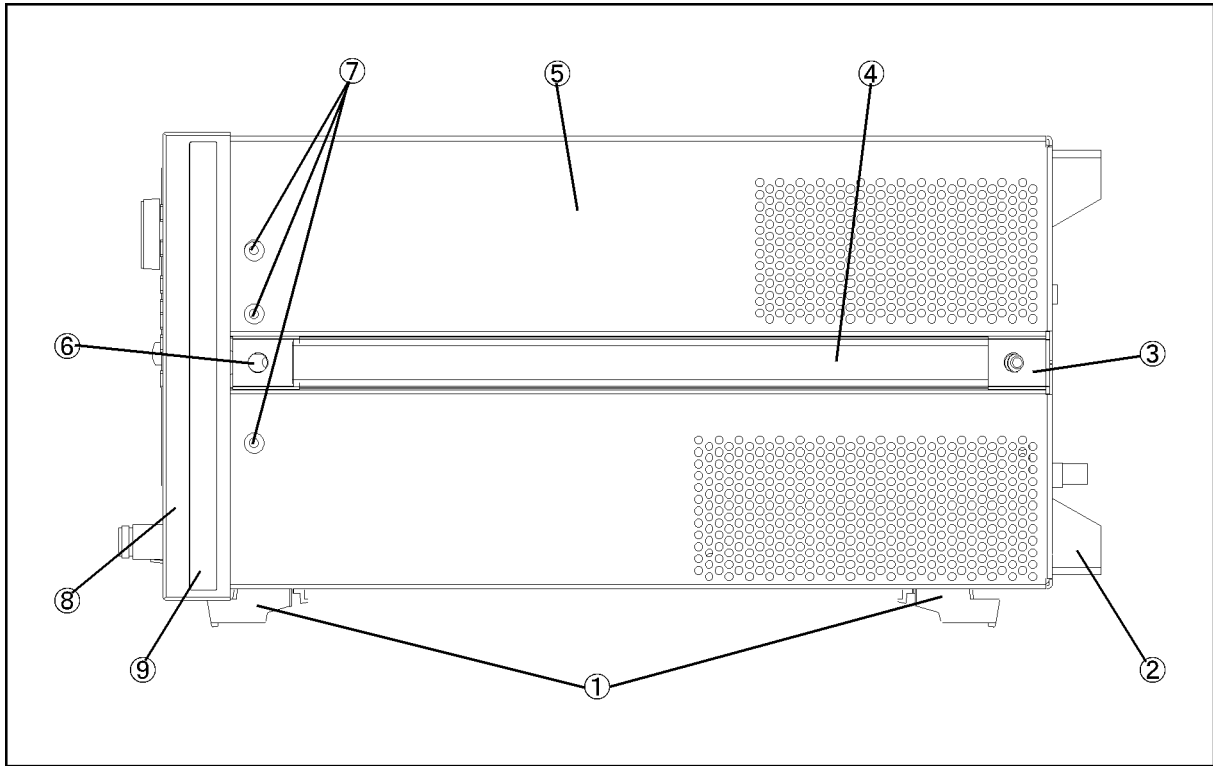

4287ase06008

Table 6-9 Side View

Ref. Desig.	Agilent Part Number	C/D	Qty.	Description
1	5041-9167	1	4	FOOT FL
	1460-1345	5	2	WIREFORM
2	E5100-40002	0	4	STANDOFF
	0515-1232	5	4	SCREW-MACH M3.5
3	5041-9187	5	2	STRAP HANDL REAR
	0515-0956	8	2	SCREW
4	5063-9209	8	2	STRAP HANDLE
5	04287-60002	7	1	COVER ASSY
6	5041-9186	4	2	STRAP HANDLE FRT
	0515-0956	8	2	SCREW
7	0515-2079	0	6	SCREW M4X8
8	5022-1190	4	1	FRONT FRAME221.5
	8160-0641	3	210 cm	GASKET BRAID
	0515-0889	6	11	SCREW-MACH M3.5X.6
9	5041-9173	9	2	SIDE TRIM 221.5

Test Head

Figure 6-10 Test Head

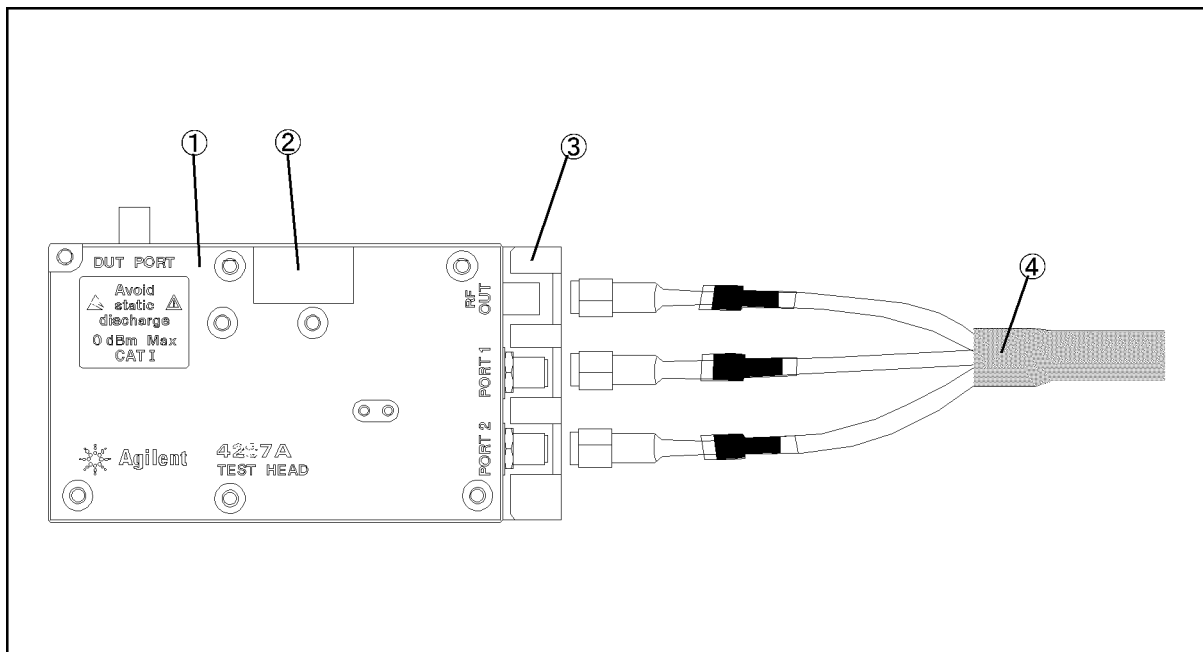

4287ase06014

Table 6-10 Test Head

Ref. Desig.	Agilent Part Number	C/D	Qty.	Description
1	04287-60111	9	1	TEST HEAD
2	5183-4071	6	1	LABEL
3	04287-04050	7	1	ANGLE
	0515-0914	8	2	SCREW-MACH M3X0.5
4	04287-61651	4	1	RF CABLE ASSY

Mass Storage Disk Drive Assembly

Figure 6-11 **Mass Storage Disk Drive Assembly**

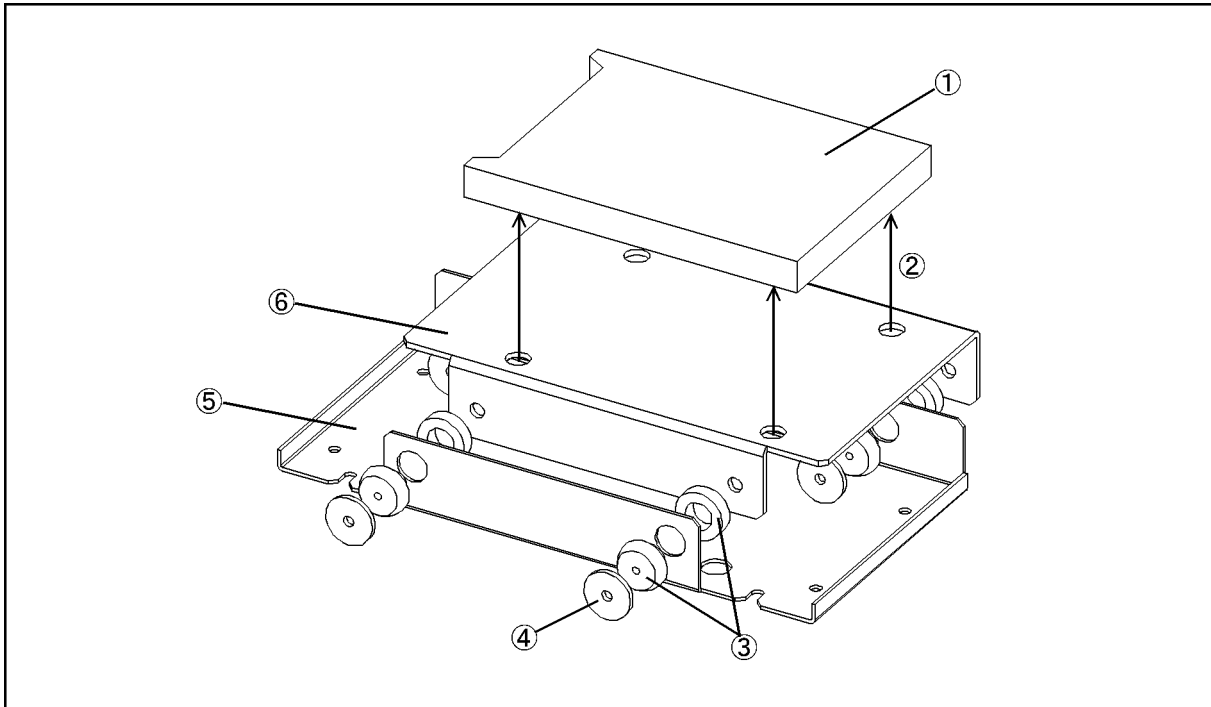

4287ase06013

Table 6-11 **Mass Storage Disk Drive Assembly**

Ref. Desig.	Agilent Part Number	C/D	Qty.	Description
1	04287-61030	3	1	HDD INSTALLED (Opt. 010)
	04287-61040	8	1	FLASH DISK INSTALLED(Opt.011)
2	0515-0924	0	4	SCREW-MACH M3X0.5
3	1410-1580	5	4	BUSHING
4	E5010-00655	6	4	PLATE
5	04287-01211	6	1	HDD BRACKET
6	04287-01204	7	1	HDD HOLDER

Power Supply Assembly

Figure 6-12 Power Supply Assembly

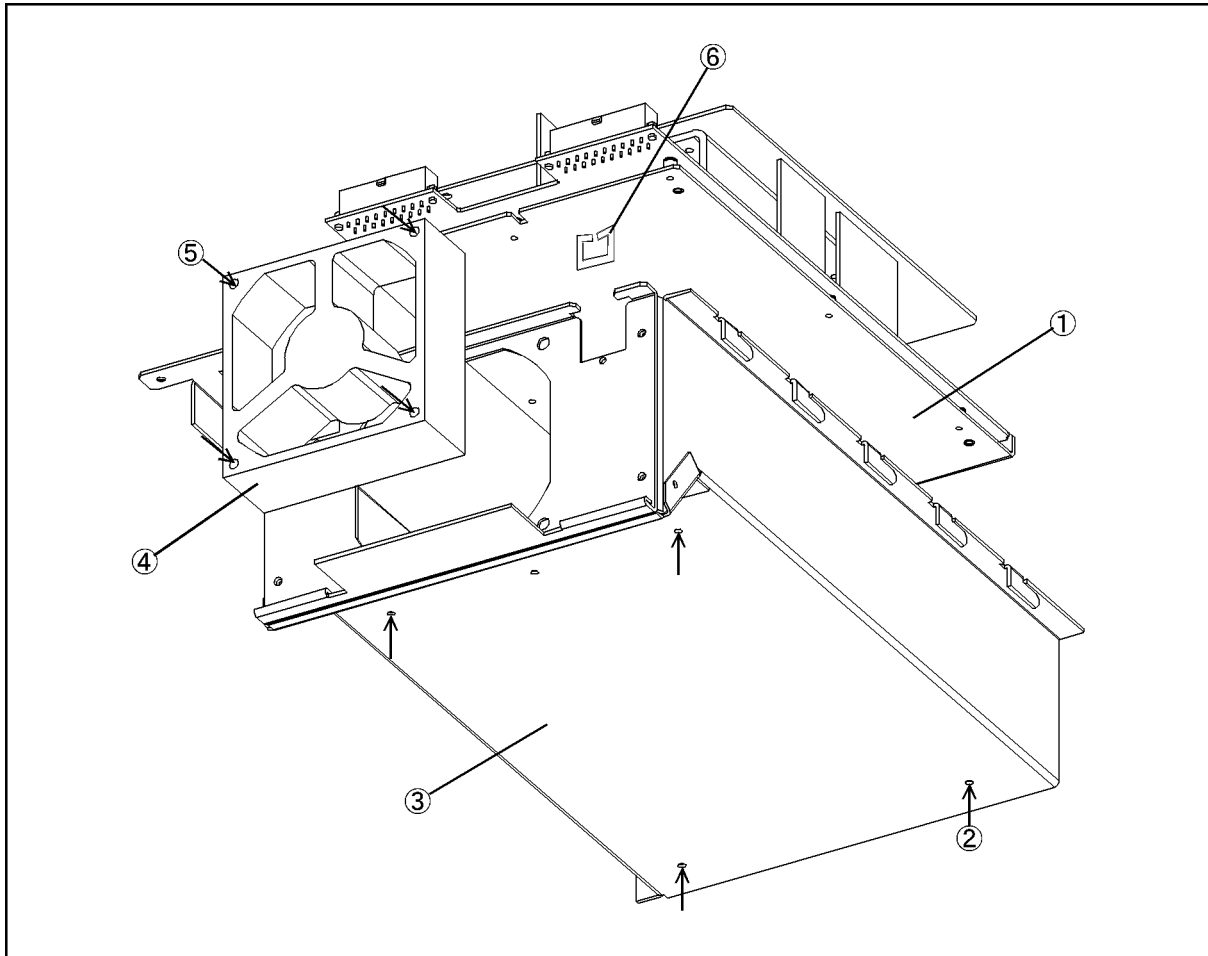

4287ase06012

Table 6-12 Power Supply Assembly

Ref. Desig.	Agilent Part Number	C/D	Qty.	Description
1	0950-3396	8	1	PWR-SPLY-225W
2	0515-0914	8	2	SCREW-MACH M3X0.5
3	04287-60003	8	1	BRACKET P/S ASSY
4	04287-61011	8	1	FAN ASSY
5	0515-1666	9	4	SCREW M4X35 POZI
6	1400-2198	2	2	SADDLE-EDGE

Other Parts

Table 6-13 Other Parts

Agilent Part Number	C/D	Qty.	Description
04287-900x4		1	OPERATION MANUAL
04287-900x1		1	PROGRAMMING MANUAL
04287-901x0		1	SERVICE MANUAL *1
04287-180x0		1	SAMPLE PROGRAM SET
04287-905xx		1	CD-ROM (manual)
5183-4163	7	1	MOUSE
C3757-60401	2	1	KEYBOARD
04287-60121	1	1	TEST FIXTURE STAND
8720-0015	3	1	WRENCH (for 3.5mm-SMA(f) connector)
1250-1746	5	1	7mm-SMA(f) ADAPTER
1250-2879	7	3	N(m)-SMA(f) ADAPTER
1250-1158	3	1	SMA(f)-SMA(f) ADAPTER *2
04191-85300	5	1	SHORT TERMINATION *3
04191-85302	7	1	OPEN TERMINATION *3
04287-60021	0	1	50 OHM TERMINATION *3
04287-60022	1	1	LOW-LOSS CAPACITOR *3
16195-60002	1	1	CARRYING CASE *3
16195-90020	6	1	OPERATION NOTE, 16195B *3

*1. Opt. 0BW only

*2. Opt. 020 only

*3. Included in 16195B Calibration Kit

Replaceable Parts List (for serial prefix MY433 and later)

Power Cables and Plug Configurations

For details of the power cables and plug configurations, refer to Appendix E, “Power Requirement,” on page 281.

Top View (Measure Assembly)

Figure 6-13 Top View (Measure Assembly)

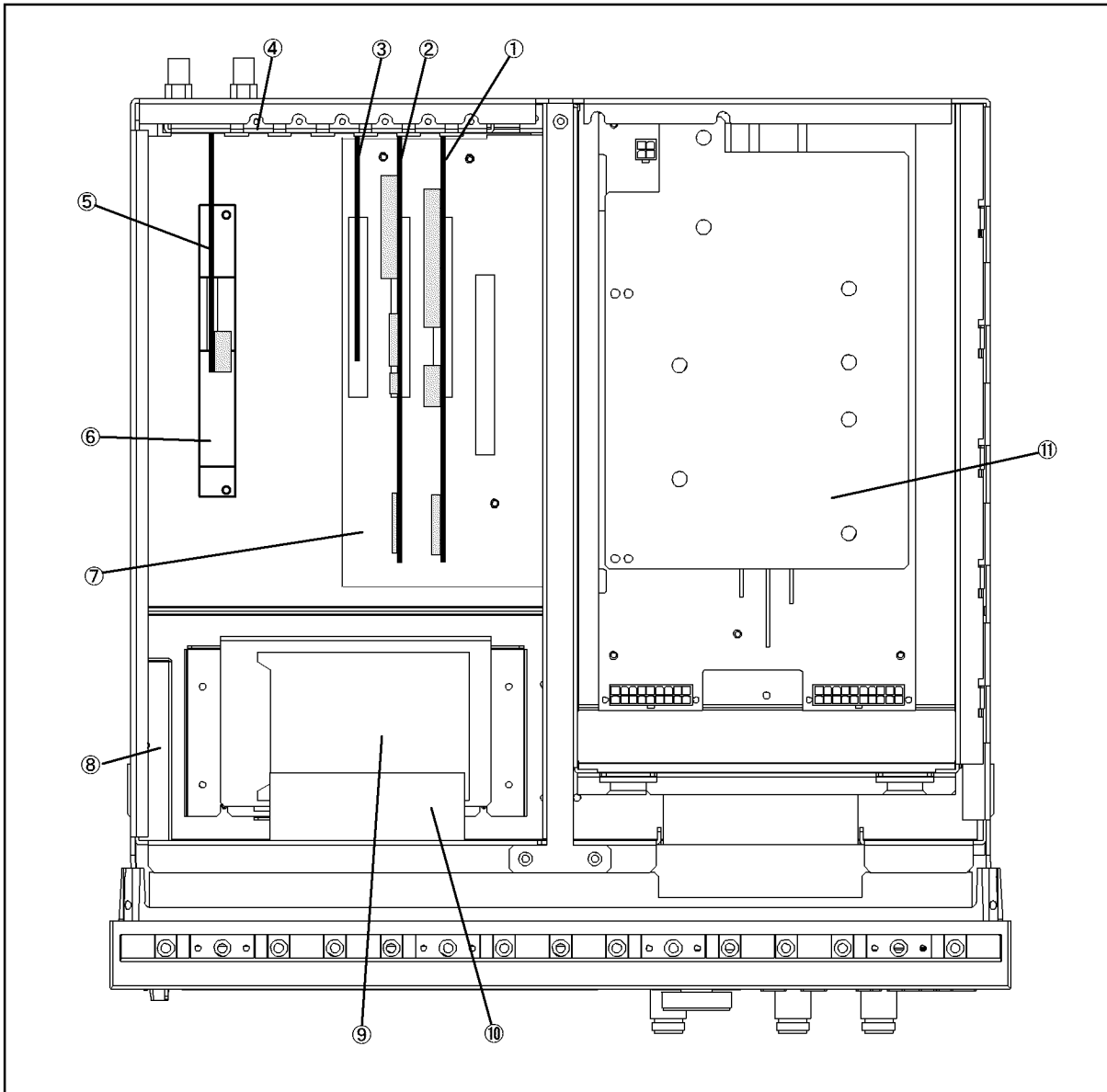

4287ase_006

Table 6-14 Top View (Measure Assembly)

Ref. Desig.	Agilent Part Number	C/D	Qty.	Description
1	04287-66531		1	A21 ANALOG INTERFACE BOARD
	1818-6491	1	1	IC, EEPROM*1
	0515-0430	3	1	SCREW M3
2	54810-66525		1	A26 DISPLAY BOARD
	04287-87101	3	1	LABEL
	0515-0430	3	1	SCREW M3
3	E5070-61007		1	A24 GPIB BOARD
	0515-0430	3	1	SCREW M3
4	04287-01210	5	3	SLOT COVER
	0515-0430	3	2	SCREW M3
5	04287-66523	9	1	A23 HANDLER INTERFACE BOARD
	0515-1550	0	2	SCREW M3-L 8 P-H
6	04287-01271		1	ANGLE
	0515-1550	0	2	SCREW M3-L 8 P-H
7	0960-2372	1	1	A20 ATX DIGITAL MOTHER BOARD
	0515-1250	7	5	SCREW M3X0.5
8	See Table 6-24		1	A28 Floppy Disk Drive Assembly
9	See Table 6-11		1	A27 Mass Storage Disk Drive Assembly
	0515-1550	0	4	SCREW M3-L 8 P-H
10	04287-61011	8	1	FAN ASSY
	0515-1666	9	4	SCREW M4X35 POZI
11	See Table 6-12		1	A50 Power Supply Assembly

*1. Included in the analog Interface board.

Replaceable Parts
Replaceable Parts List (for serial prefix MY433 and later)

Top View (Cables & Other Parts)

Figure 6-14

Top View (Cable & Other Parts)

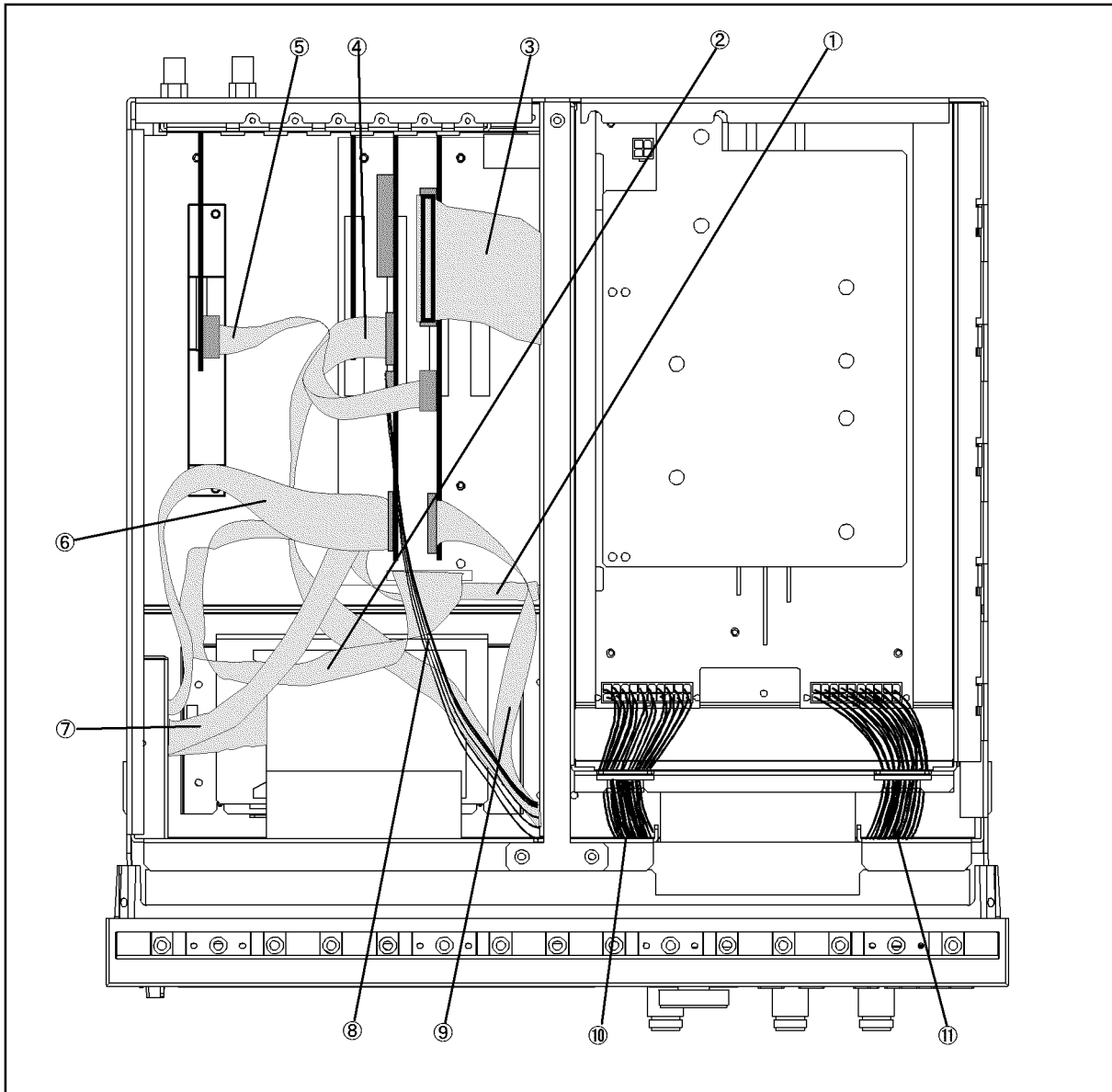

e5052ase092

Table 6-15 Top View (Cables)

Ref. Desig.	Agilent Part Number	C/D	Qty.	Description
1	54801-61610	4	1	FLAT CABLE ASSY
2	54801-61611	5	1	FLAT CABLE ASSY
3	04396-61707	3	1	CABLE ASSY
4	04287-61607	0	1	FLAT CABLE
5	04287-61608	1	1	FLAT CABLE ASSY
6	E5100-61661	1	1	CABLE FLAT 26PIN
7	54801-61636	4	1	FLAT CABLE ASSY
8	54801-61635	3	1	WIRE ASSY
9	04287-61609	2	1	FLAT CABLE ASSY
10	04287-61632	1	1	WIRE ASSY
11	04287-61633	2	1	WIRE ASSY

Replaceable Parts
Replaceable Parts List (for serial prefix MY433 and later)

Top View (Miscellaneous Parts)

Figure 6-15

Top View (Miscellaneous Parts)

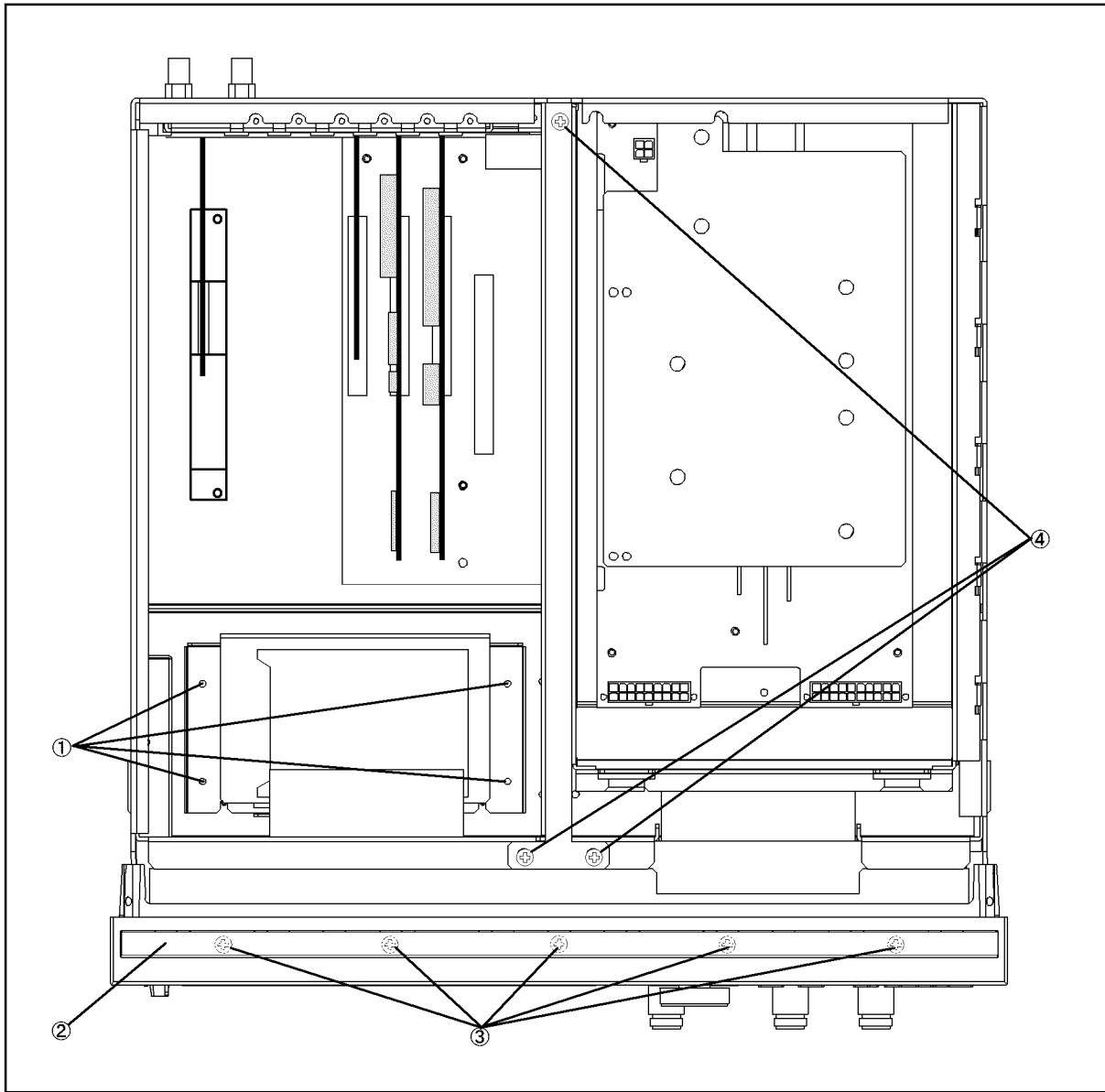

4287ase_008

Table 6-16 Top View (Under Power Supply)

Ref. Desig.	Agilent Part Number	C/D	Qty.	Description
1	0515-1550	0	4	SCREW M3-L 8 P-H
2	5041-9176	2	1	TRIM STRIP
3	0515-0889	6	5	SCREW-MACH M3.5X.6
	0515-0889	6	6	SCREW-MACH M3.5X.6 (Bottom Side)
4	0515-0914	8	3	SCREW-MACH M3X0.5

Replaceable Parts
Replaceable Parts List (for serial prefix MY433 and later)

Top View (Under Power Supply)

Figure 6-16

Top View (Under Power Supply)

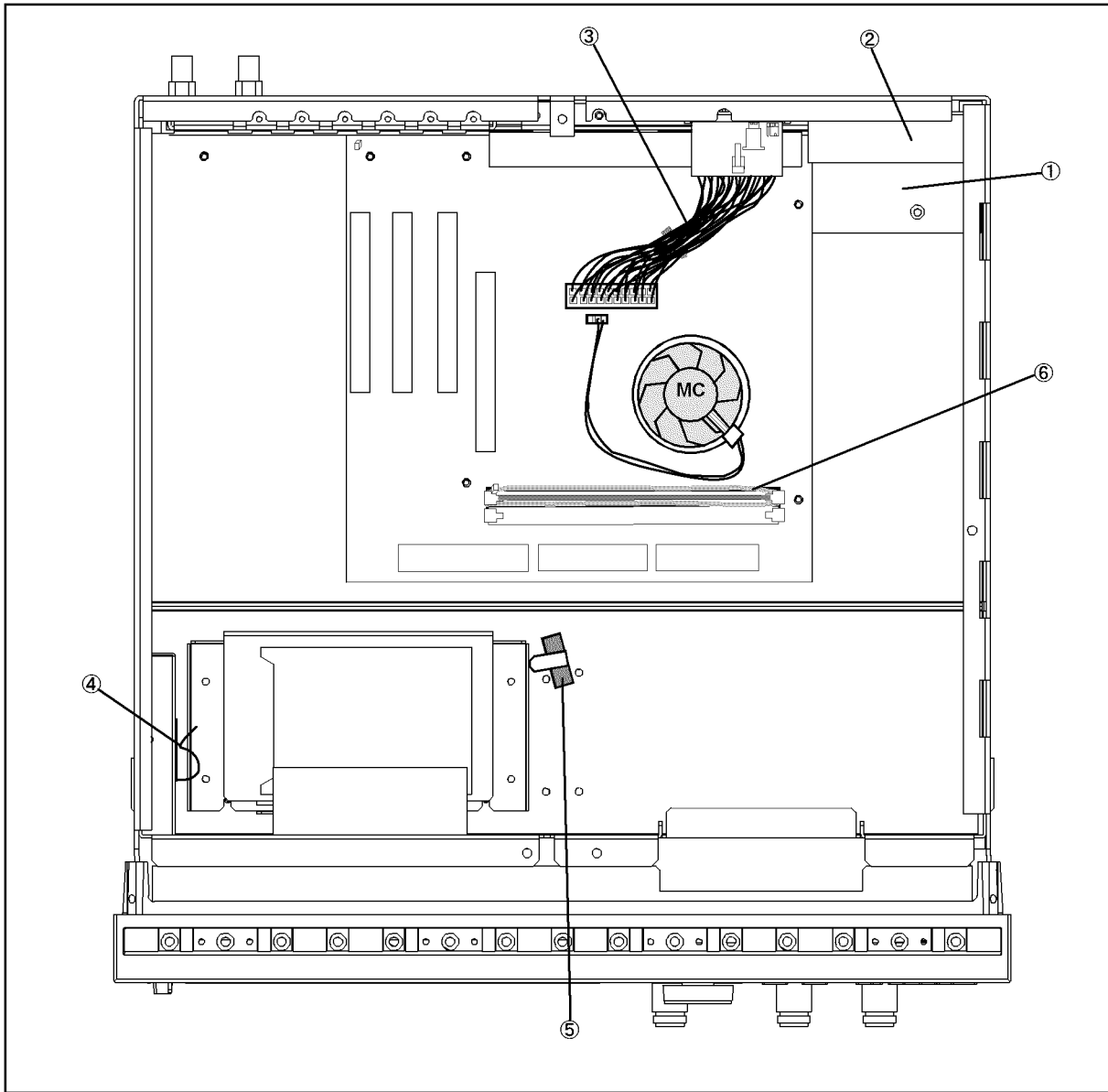

4287ase_009

Table 6-17 Top View (Under Power Supply)

Ref. Desig.	Agilent Part Number	C/D	Qty.	Description
1	04287-01213	8	1	COVER
	0515-1550	0	1	SCREW M3-L 8 P-H
	0515-0914	8	3	SCREW-MACH M3X0.5
2	04287-66510	4	1	ANALOG MOTHER
	0515-1550	0	10	SCREW M3-L 8 P-H
3	04287-61631	0	1	WIRE ASSY
4	1400-0611	0	1	CABLE CLAMP
5	1400-1334	6	1	CLAMP CABLE
6	1400-3207		1	CABLE CLAMP

Replaceable Parts
Replaceable Parts List (for serial prefix MY433 and later)

Front View (Analog Boards and Semi Rigid Cables)

Figure 6-17

Front View (Analog Boards and Semi Rigid Cables)

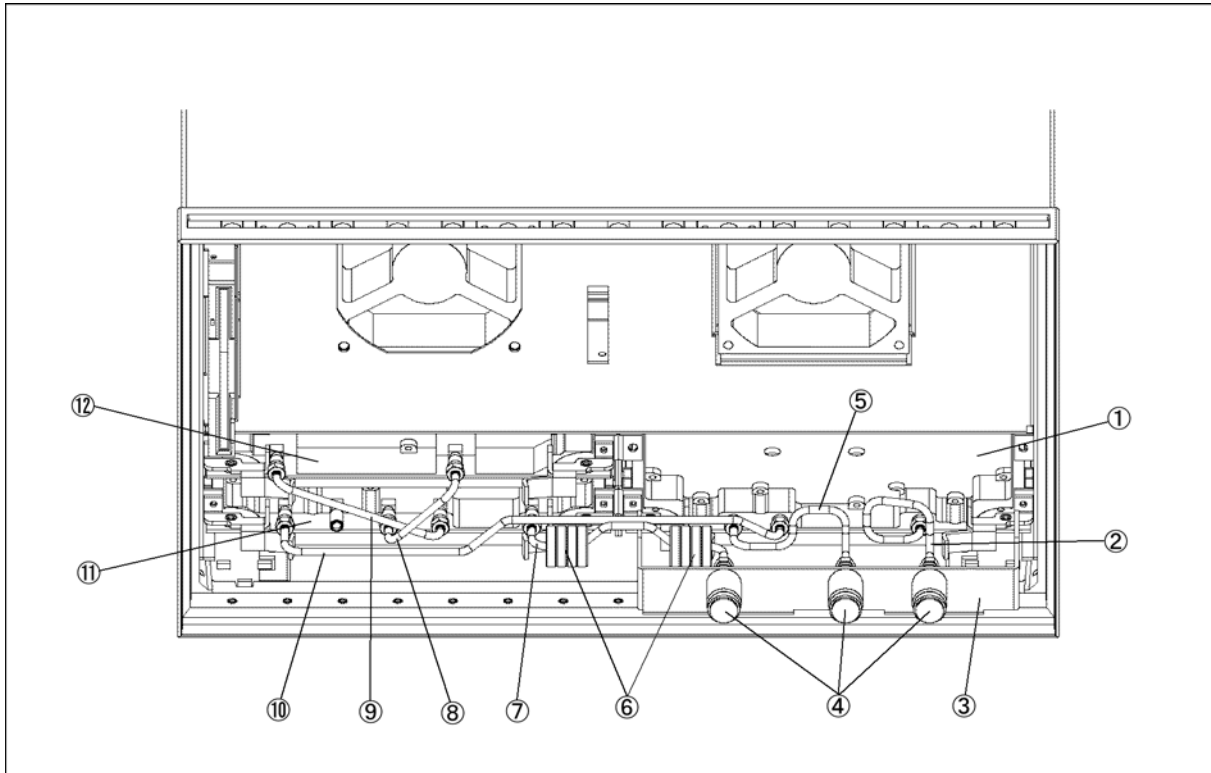

4287ase06005

Table 6-18 Front View (Analog Boards and Semi Rigid Cables)

Ref. Desig.	Agilent Part Number	C/D	Qty.	Description
1	04287-66554	8	1	A4 RECEIVER BOARD
	04287-69554	4	1	A4 RECEIVER BOARD (Exchange)
	0515-1550	0	2	SCREW M3-L 8 P-H
2	04287-61601	4	1	RF CABLE ASSY
3	04287-01201	4	1	BRACKET CONNECT
	0515-0924	0	4	SCREW-MACH M3X0.5
4	5061-5386	0	3	CONN TP N (UTIL)
	2950-0132	6	3	NUT-HEX-DUB-CHAM
	2190-0104	0	3	WSHR-LK INTL T
5	04287-61603	6	1	RF CABLE ASSY SRGD
6	9170-1468	6	8	CORE-TROID
	1400-0249	0	2	CABLE TIE
7	04287-61604	7	1	RF CABLE ASSY
8	04287-61605	8	1	RF CABLE ASSY
9	04287-61606	9	1	RF CABLE ASSY
10	04287-61602	5	1	RF CABLE ASSY
11	04287-66553	7	1	A3 SOURCE BOARD
	04287-69553	3	1	A3 SOURCE BOARD (Exchange)
	0515-1550	0	2	SCREW M3-L 8 P-H
12	04287-66511	5	1	A1 REFERENCE OSCILLATOR
	04287-69511	1	1	A1 REFERENCE OSCILLATOR (Exchange)
	0515-1550	0	2	SCREW M3-L 8 P-H

Front Panel

Figure 6-18 Front Panel

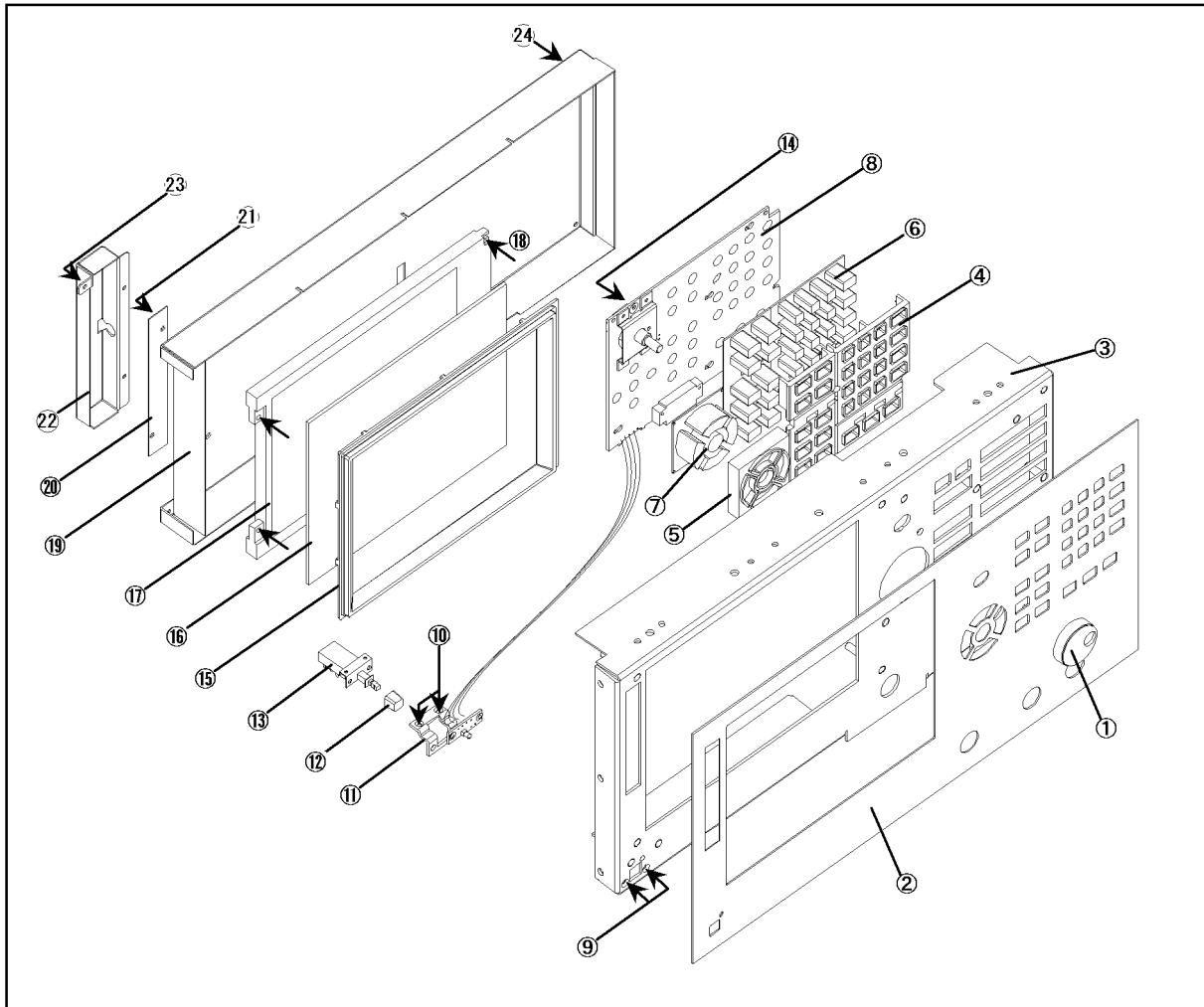

4287ase06009

Table 6-19 Front Panel

Ref. Desig.	Agilent Part Number	C/D	Qty.	Description
1	5182-7594	2	1	KNOB
2	04287-00201	2	1	FRONT PANEL
3	04287-00202	3	1	SUB PANEL
4	E5100-40001	9	1	FRONT BEZEL
5	04287-40003	6	1	GUIDE FOR CURSOR KEY
6	04287-25001	2	1	RUBBER KEY
7	04287-25002	3	1	RUBBER KEY (CURSOR)
8	04287-66522	8	1	FRONT KEYBOARD
9	0515-0914	8	2	SCREW-MACH M3X0.5
10	0515-0999	9	2	SCREW M2.5X0.45 L=6 FL
11	04287-01212	7	1	BRACKET SW
12	5041-0564	4	1	KEY CAP
13	04287-61901	7	1	WIRE ASSY WITH SWITCH
14	0515-1550	0	1	SCREW M3-L 8 P-H
15	04287-40001	4	1	FRONT BEZEL
16	04287-25003	4	1	OPTICAL FILTER
17	2090-0396	0	1	LCD-DISPLAY
	04287-25004	5	1	GASKET
18	0515-1550	0	4	SCREW M3-L 8 P-H
19	04287-00601	6	1	COVER SHIELD
20	0950-3235	4	1	INVERTER
21	0515-1550	0	2	SCREW M3-L 8 P-H
22	04287-01215	0	1	ANGLE
23	0515-1550	0	3	SCREW M3-L 8 P-H
24	0515-1550	0	6	SCREW M3-L 8 P-H

Replaceable Parts
 Replaceable Parts List (for serial prefix MY433 and later)

Front Panel (Back Side)

Figure 6-19 Front Panel (Back Side)

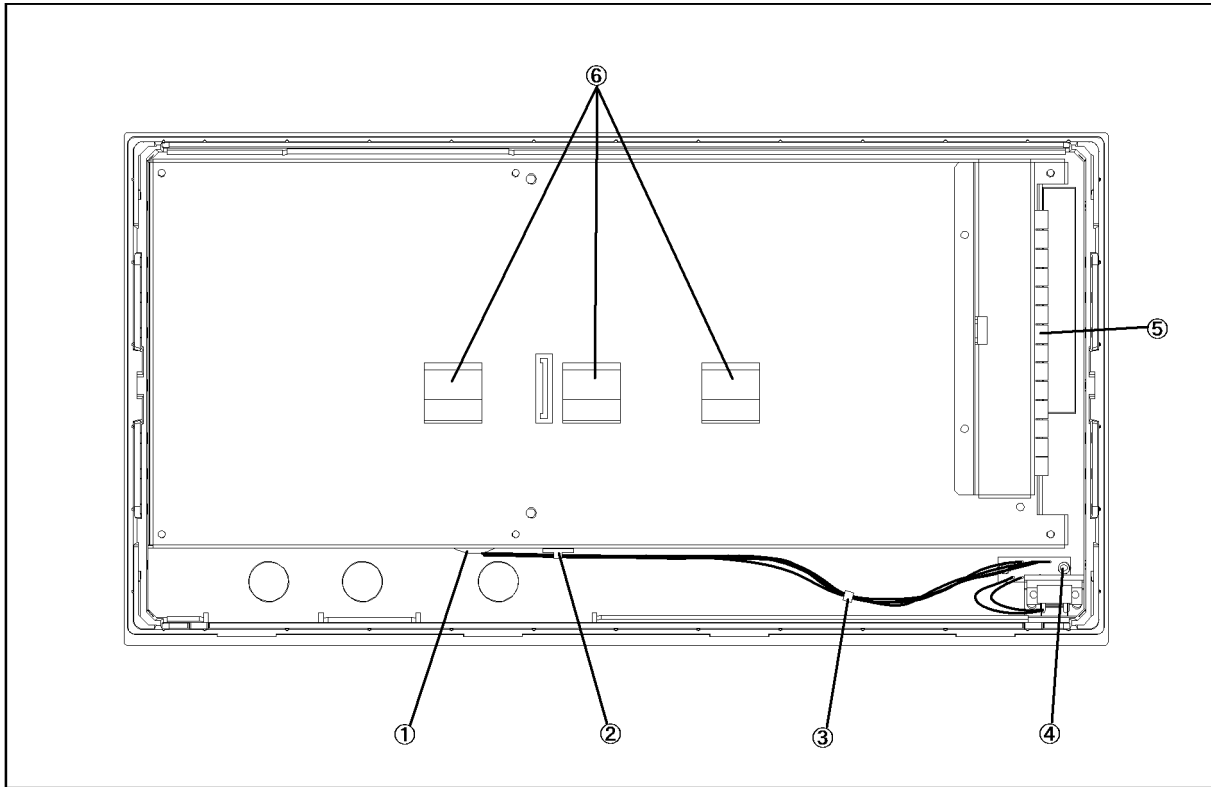

4287ase06015

Table 6-20 Front View (Analog Boards and Semi Rigid Cables)

Ref. Desig.	Agilent Part Number	C/D	Qty.	Description
1	0400-0010	2	1	ROUND GROMET
2	1400-1334	6	1	CABLE CLAMP
3	1400-0249	0	1	CABLE TIE
4	0515-1550	0	2	SCREW M3-L 8 P-H
5	0363-0170	5	9 cm	RFI GASKET
6	1400-0611	0	3	CABLE CLAMP

Rear View

Figure 6-20

Rear View

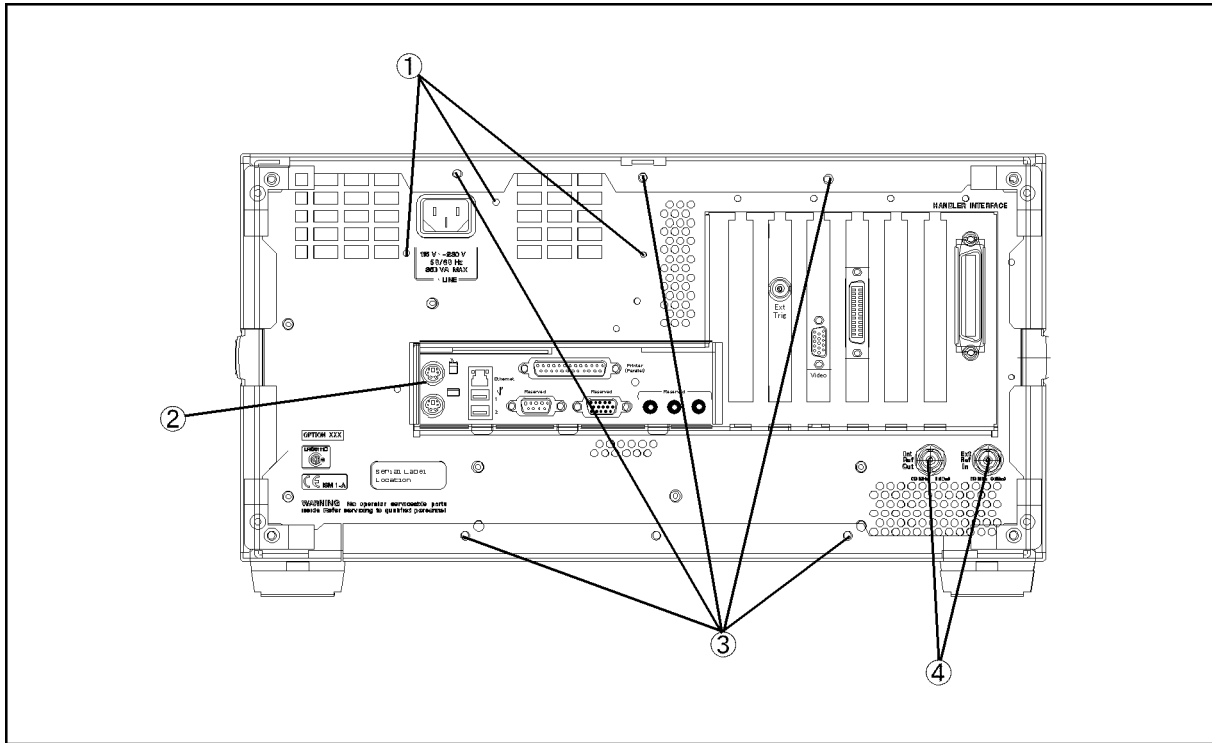

4287ase_010

Table 6-21

Rear View

Ref. Desig.	Agilent Part Number	C/D	Qty.	Description
1	0515-1550	0	3	SCREW M3-L 8 P-H
2	04287-01270		1	REAR COVER I/O
	0515-0914	8	2	SCREW-MACH M3X0.5
3	0515-1232	5	6	SCREW-MACH M3.5
4	2950-0054	1	2	NUT-HEX-DBL-CHAM
	2190-0054	9	2	WSHR-LK INTL T

Replaceable Parts
Replaceable Parts List (for serial prefix MY433 and later)

Side View

Figure 6-21 Side View

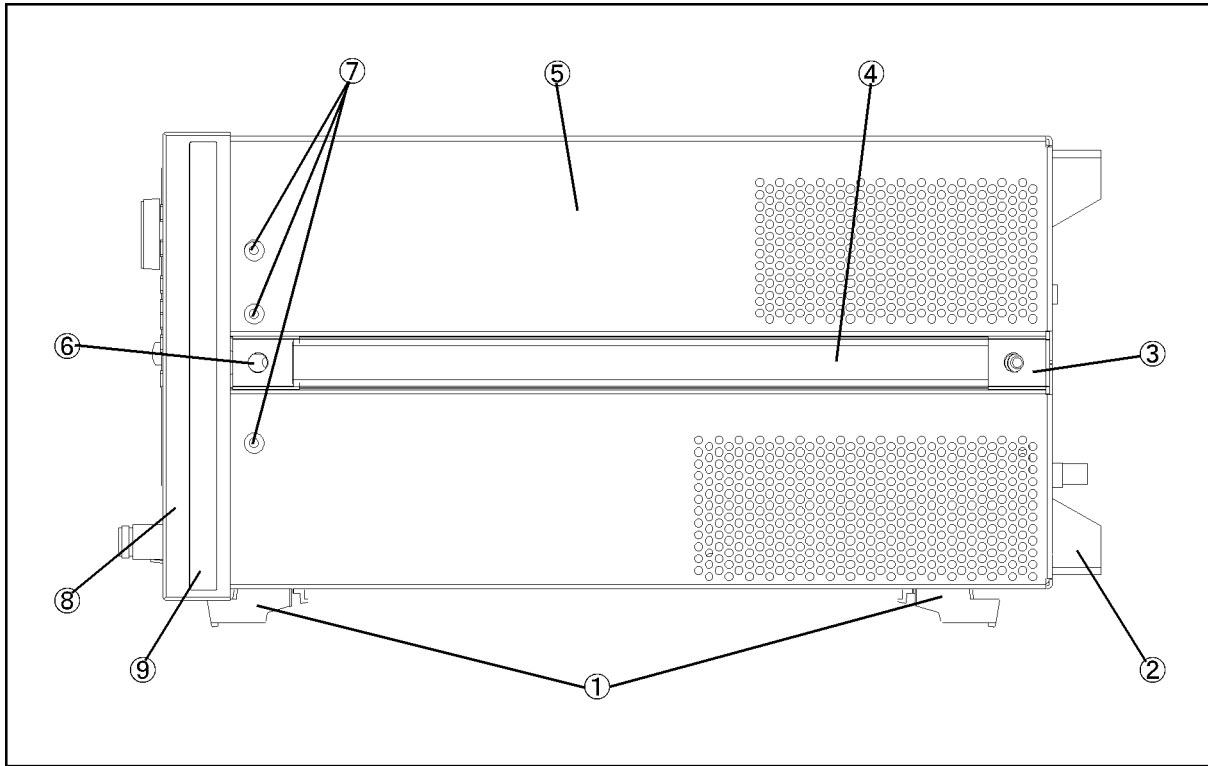

4287ase06008

Table 6-22 Side View

Ref. Desig.	Agilent Part Number	C/D	Qty.	Description
1	5041-9167	1	4	FOOT FL
	1460-1345	5	2	WIREFORM
2	E5100-40002	0	4	STANDOFF
	0515-1232	5	4	SCREW-MACH M3.5
3	5041-9187	5	2	STRAP HANDL REAR
	0515-0956	8	2	SCREW
4	5063-9209	8	2	STRAP HANDLE
5	04287-60002	7	1	COVER ASSY
6	5041-9186	4	2	STRAP HANDLE FRT
	0515-0956	8	2	SCREW
7	0515-2079	0	6	SCREW M4X8
8	5022-1190	4	1	FRONT FRAME221.5
	8160-0641	3	210 cm	GASKET BRAID
	0515-0889	6	11	SCREW-MACH M3.5X.6
9	5041-9173	9	2	SIDE TRIM 221.5

Test Head

Figure 6-22 Test Head

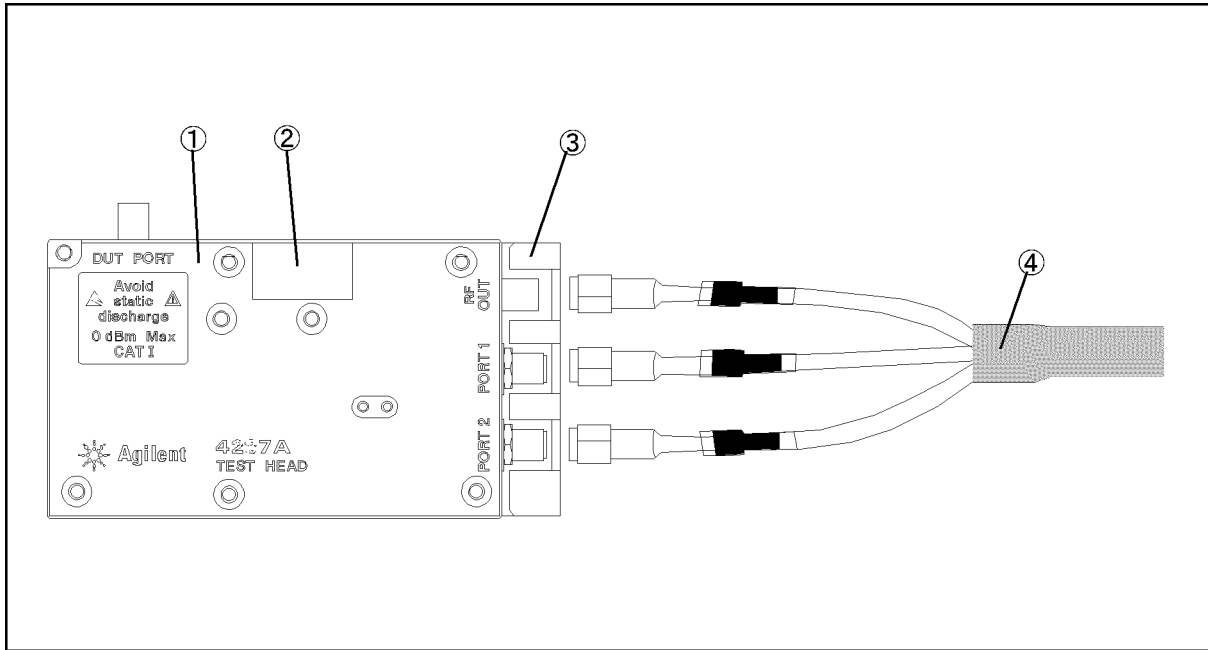

4287ase06014

Table 6-23 Test Head

Ref. Desig.	Agilent Part Number	C/D	Qty.	Description
1	04287-60111	9	1	TEST HEAD
2	5183-4071	6	1	LABEL
3	04287-04050	7	1	ANGLE
	0515-0914	8	2	SCREW-MACH M3X0.5
4	04287-61651	4	1	RF CABLE ASSY

Floppy Disk Drive Assembly

Figure 6-23 Floppy Disk Drive Assembly

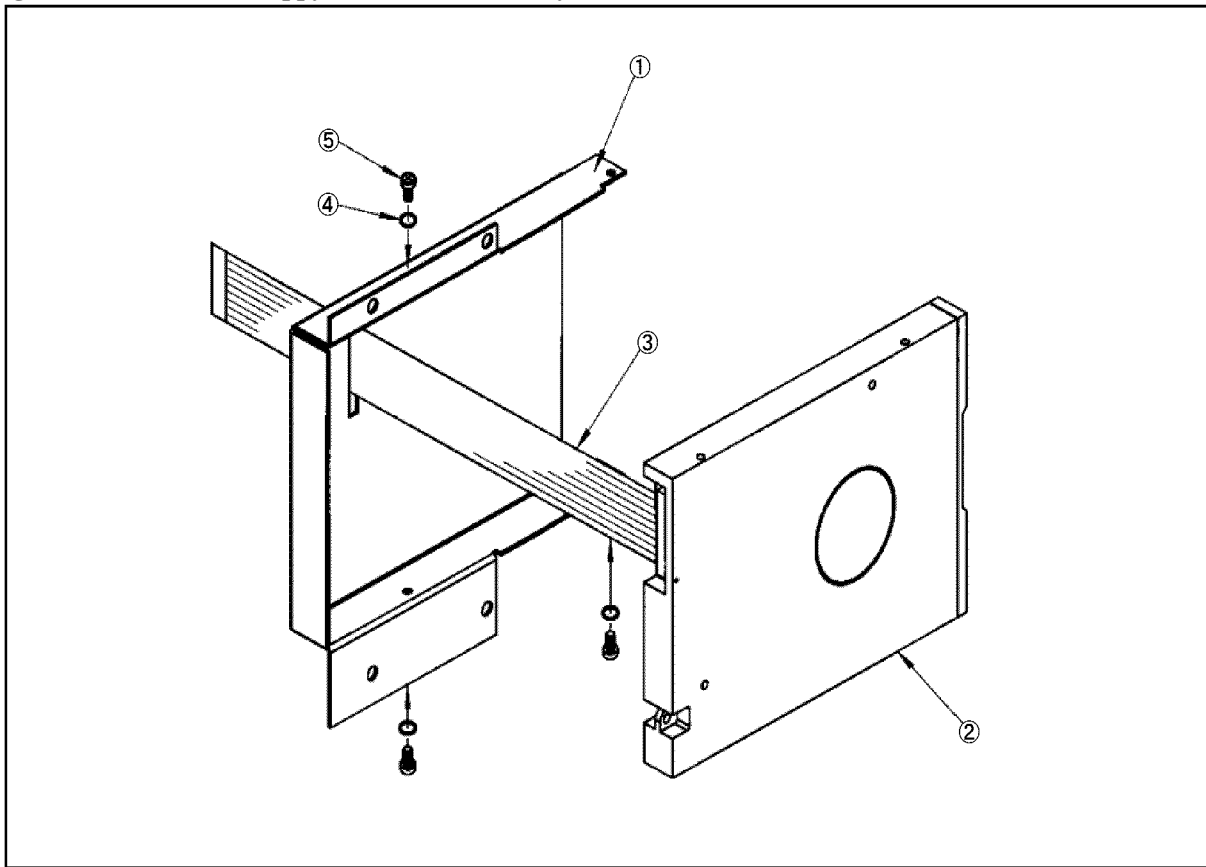

e4991ase096

Table 6-24 Floppy Disk Drive Assembly

Ref. Desig.	Agilent Part Number	C/D	Qty.	Description
1	0950-4325		1	A28 FLOPPY DISK DRIVE
2	04287-01203	6	1	FDD HOLDER
3	E5100-61661	1	1	CABLE FLAT 26PIN
4	2190-0583		3	M2.5 SPRING WASH
5	0515-1056	1	3	SCREW

Mass Storage Disk Drive Assembly

Figure 6-24 Mass Storage Disk Drive Assembly

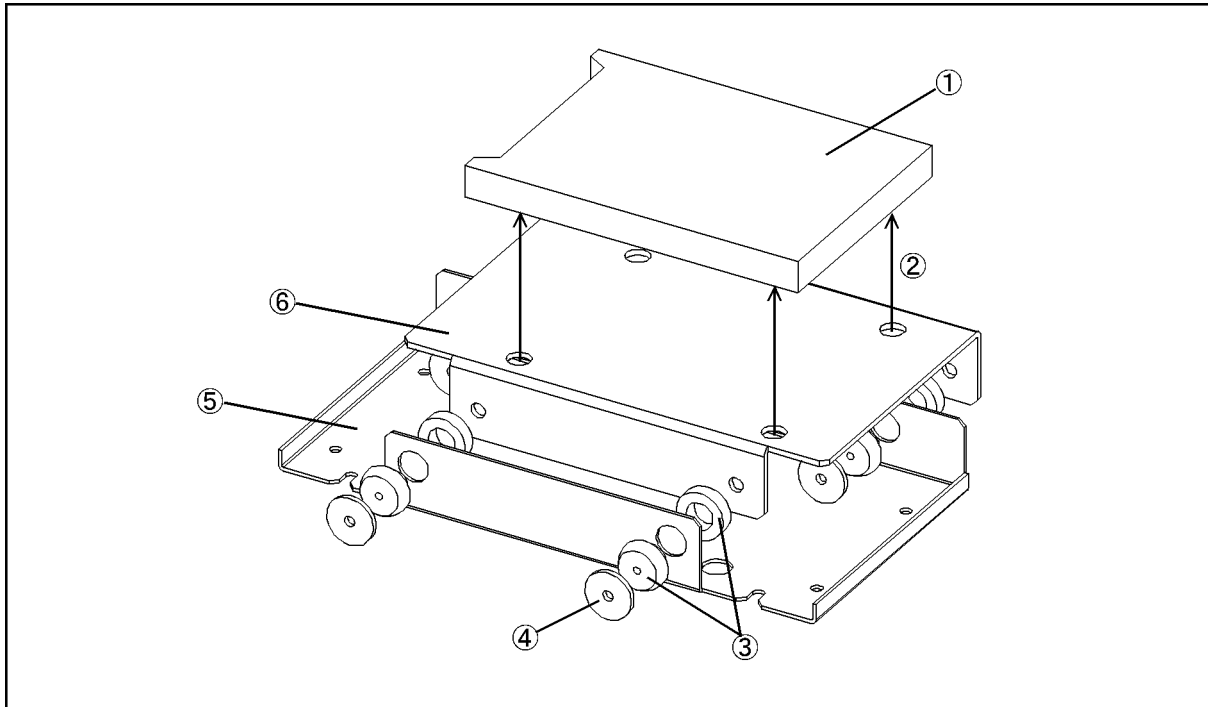

4287ase06013

Table 6-25 Mass Storage Disk Drive Assembly

Ref. Desig.	Agilent Part Number	C/D	Qty.	Description
1	04287-61200		1	HDD INSTALLED
2	0515-0924	0	4	SCREW-MACH M3X0.5
3	1410-1580	5	4	BUSHING
4	E5070-24011	6	4	PLATE
5	04287-01211	6	1	HDD BRACKET
6	04287-01204	7	1	HDD HOLDER

Power Supply Assembly

Figure 6-25 Power Supply Assembly

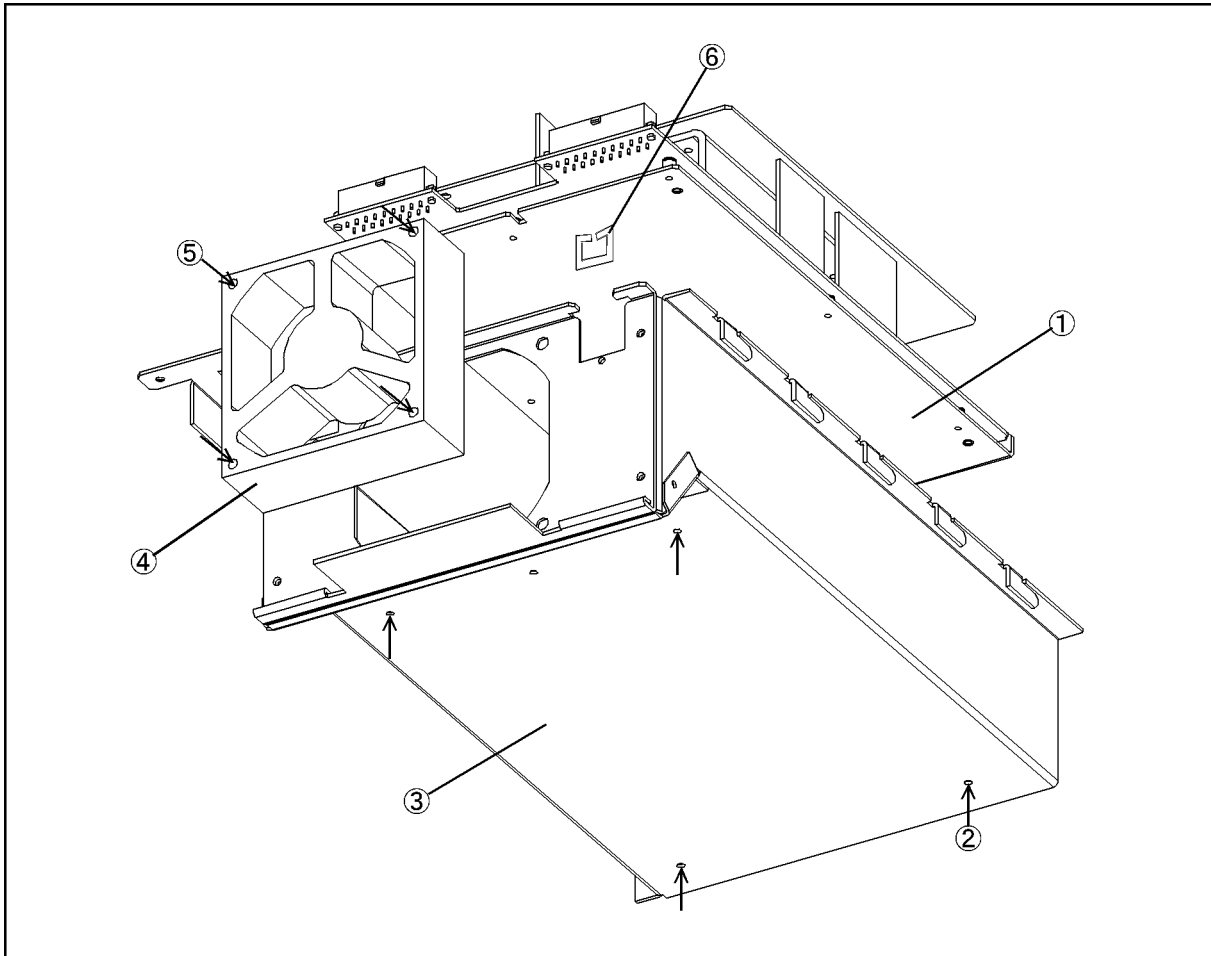

4287ase06012

Table 6-26 Power Supply Assembly

Ref. Desig.	Agilent Part Number	C/D	Qty.	Description
1	0950-3396	8	1	PWR-SPLY-225W
2	0515-0914	8	2	SCREW-MACH M3X0.5
3	04287-60003	8	1	BRACKET P/S ASSY
4	04287-61011	8	1	FAN ASSY
5	0515-1666	9	4	SCREW M4X35 POZI
6	1400-2198	2	2	SADDLE-EDGE

Replaceable Parts
Replaceable Parts List (for serial prefix MY433 and later)

Other Parts

Table 6-27 Other Parts

Agilent Part Number	C/D	Qty.	Description
04287-900x4		1	OPERATION MANUAL
04287-900x1		1	PROGRAMMING MANUAL
04287-901x0		1	SERVICE MANUAL *1
04287-180x0		1	SAMPLE PROGRAM SET
04287-905xx		1	CD-ROM (manual)
5183-4163	7	1	MOUSE
C3757-60401	2	1	KEYBOARD
04287-60121	1	1	TEST FIXTURE STAND
8720-0015	3	1	WRENCH (for 3.5mm-SMA(f) connector)
1250-1746	5	1	7mm-SMA(f) ADAPTER
1250-2879	7	3	N(m)-SMA(f) ADAPTER
1250-1158	3	1	SMA(f)-SMA(f) ADAPTER *2
04191-85300	5	1	SHORT TERMINATION *3
04191-85302	7	1	OPEN TERMINATION *3
04287-60021	0	1	50 OHM TERMINATION *3
04287-60022	1	1	LOW-LOSS CAPACITOR *3
16195-60002	1	1	CARRYING CASE *3
16195-90020	6	1	OPERATION NOTE, 16195B *3

*1.Opt. 0BW only

*2.Opt. 020 only

*3.Included in 16195B Calibration Kit

7**Replacement Procedure**

This chapter provides procedure for removing and replacing the major assemblies in the 4287A RF LCR Meter.

Replacing an Assembly

The following steps show the sequence to replace an assembly in a 4287A RF LCR Meter.

1. Identify the faulty group. Refer to Chapter 6, “Replaceable Parts.”
2. Order a replacement assembly. Refer to Chapter 7, “Replacement Procedure.”
3. Replace the faulty assembly and determine what adjustments are necessary. Refer to Chapter 7, “Replacement Procedure.”
4. Perform the necessary adjustments. Refer to Chapter 3, “Adjustment.”
5. Perform the necessary performance tests. Refer to Chapter 2, “Maintenance.”

WARNING These servicing instructions are for use by qualified personnel only. To avoid electrical shock, do not perform any servicing unless you are qualified to do so.

WARNING The opening of covers or removal of parts is likely to expose dangerous voltages. Disconnect the instrument from its power supply.

CAUTION Many of the assemblies in this instrument are very susceptible to damage from ESD(electrostatic discharge). Perform the following procedures only at a static-safe workstation and wear a grounding strap.

Outer Cover Removal

Tools Required

- Torx screwdriver, T15
- Pozidriv screwdriver, pt size #2 (medium)

Procedure

- Step 1.** Disconnect the power cable from the 4287A.
- Step 2.** Remove the four rear feet.
- Step 3.** Remove the six screws holding the outer cover from the rear side.
- Step 4.** Remove the side strap handles.
- Step 5.** Turn the 4287A over.
- Step 6.** Remove eight screws from the bottom side.
- Step 7.** Remove four bottom feet.

NOTE

If bottom feet is not be removed, outer cover won't be removed smooth.

- Step 8.** Put a plastic cover(p/n 5040-6973) on the front panel of the 4287A and place the 4287A on flat table with its front panel down.
- Step 9.** Slide up the outer cover and remove it carefully.

Front Panel Removal

Tools Required

- Pozidriv screwdriver, pt size #2 (medium)
- Flat edge screwdriver

Procedure

Step 1. Remove the top trim with a flat edge driver.

Step 2. Remove the nine screws from top and bottom sides of the front frame as shown in Figure 7-1.

Figure 7-1 Screws fastening Front Panel

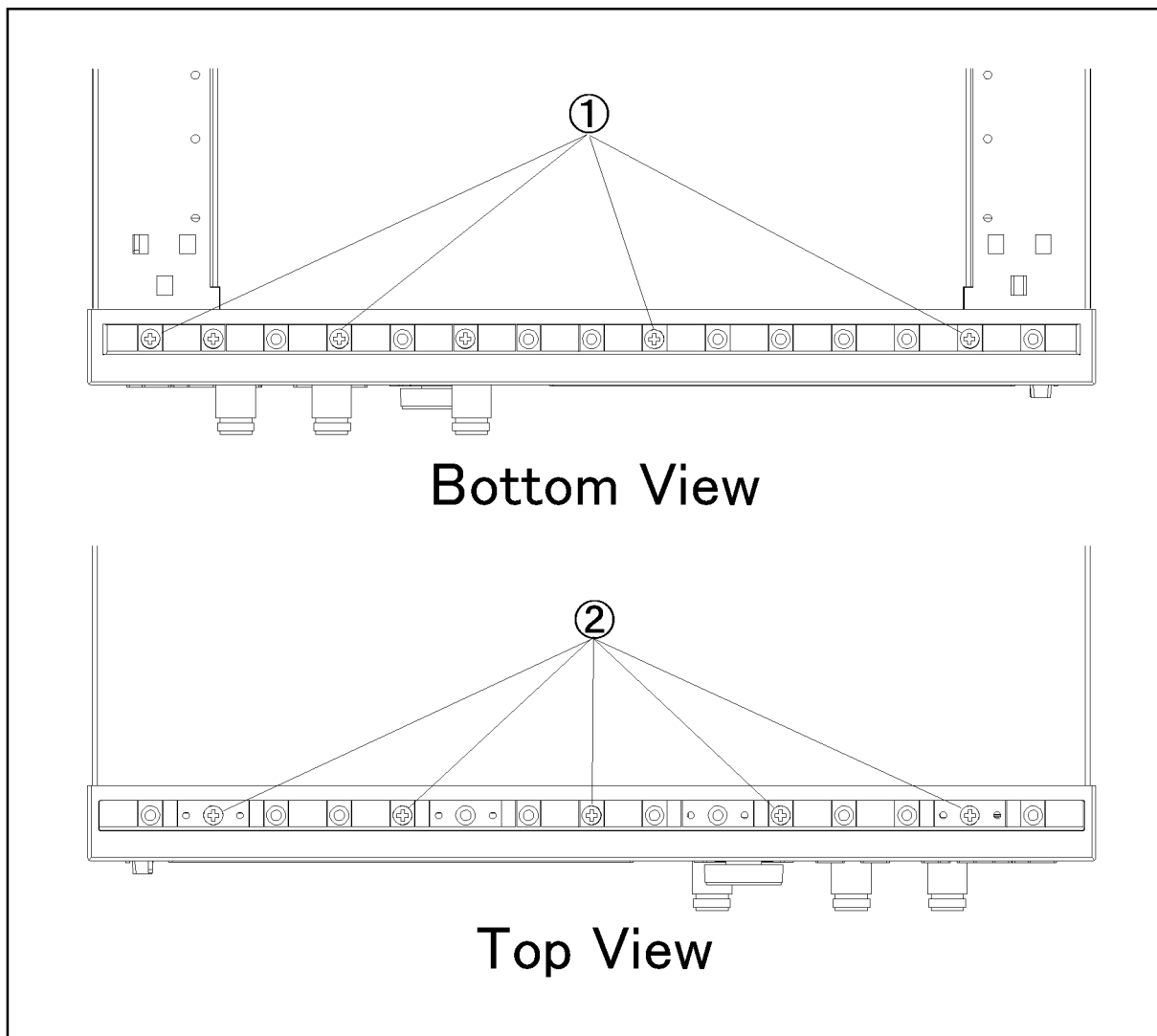

e4991ase050

Step 3. Gradually pull the front panel assembly towards the front by holding knob.

A50 Power Supply Assembly Removal (for serial prefix JP1KG, JP2KG, and MY432)

Tools Required

- Pozidriv screwdriver, pt size #1 (small)

Procedure

Step 1. Remove the outer cover as described in “Outer Cover Removal”

Step 2. Disconnect cables connected to the power supply

Step 3. Remove three flat head screws from top side.(item 1 in Figure 7-2)

Step 4. Remove the three screws from the rear panel.(item 2 in Figure 7-2)

Figure 7-2 Power Supply Assembly removal

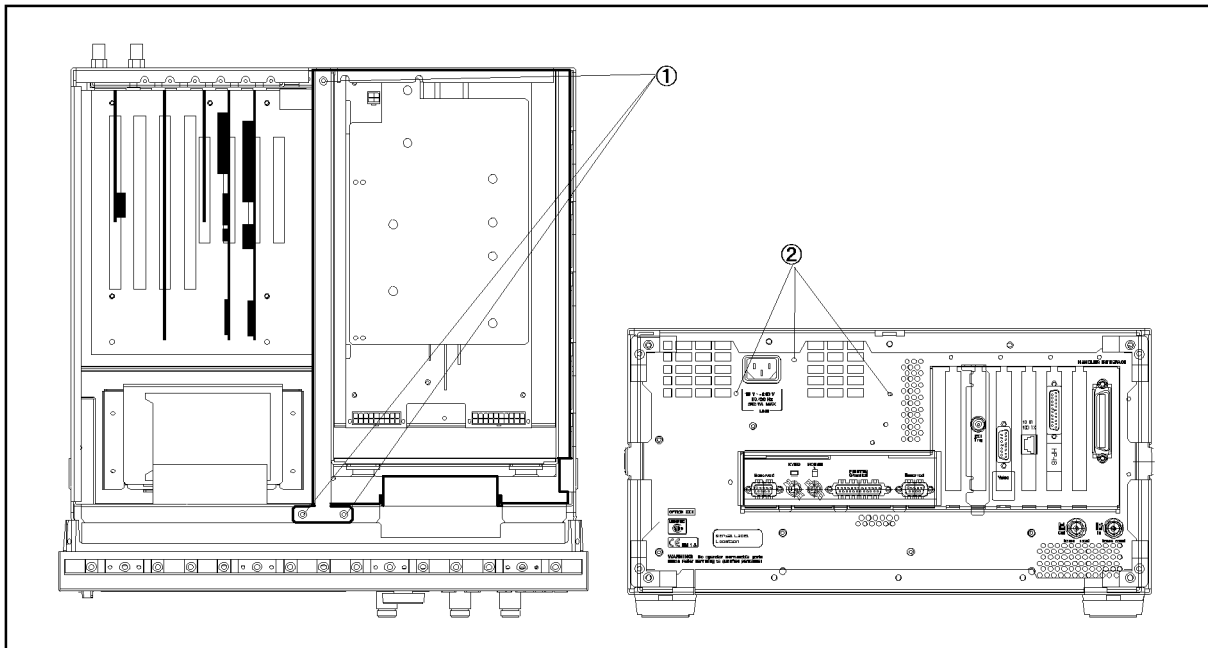

4287ase07003

Step 5. Slide the power supply assembly toward front side, and lift it.

A50 Power Supply Assembly Removal (for serial prefix MY433 and later)

Tools Required

- Pozidriv screwdriver, pt size #1 (small)

Procedure

- Step 1.** Remove the outer cover as described in “Outer Cover Removal”.
- Step 2.** Disconnect cables connected to the power supply.
- Step 3.** Remove the three flat head screws from top side. (item 1 in Figure 7-3)
- Step 4.** Remove the three screws from the rear panel. (item 2 in Figure 7-3)

Figure 7-3 Power Supply Assembly removal

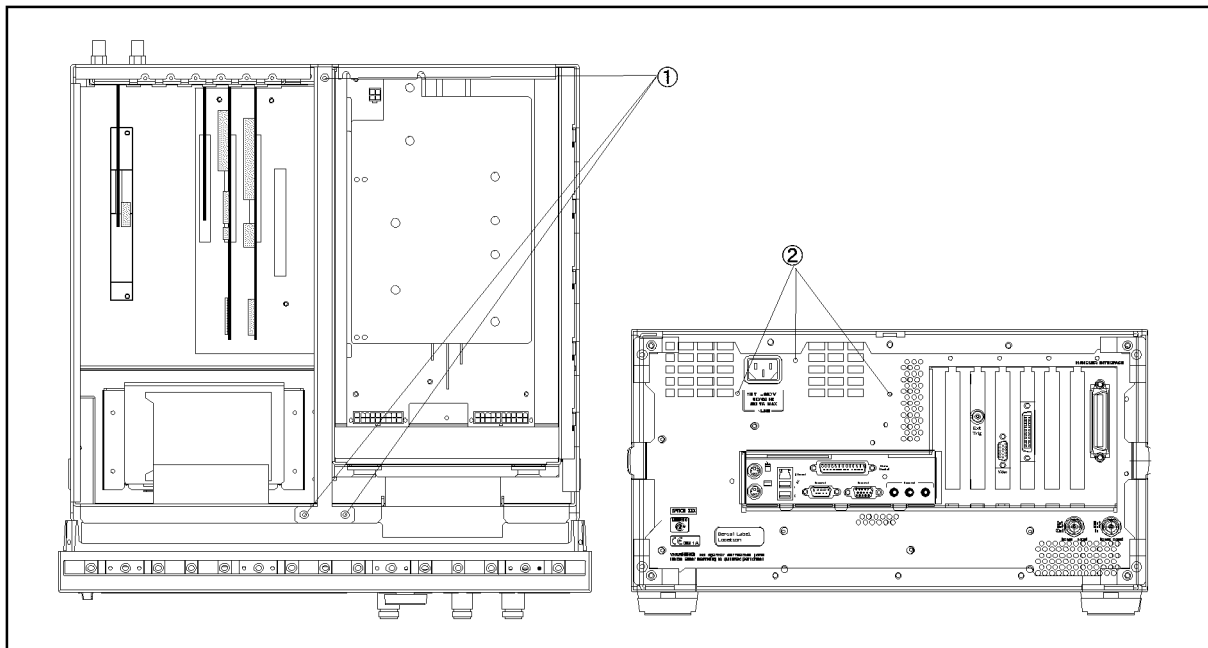

4287ase_003

- Step 5.** Slide the power supply assembly toward front side, and lift it.

A27 Mass Storage Disk Drive Assembly Removal

Tools Required

- Pozidriv screwdriver, pt size #1 (small)

Procedure

- Step 1.** Remove the outer cover as described in “Outer Cover Removal”
- Step 2.** Disconnect all cables connected to the mass storage disk drive assembly.
- Step 3.** Remove four screws fastening the mass storage disk drive assembly to the chassis.(item 1 in Figure 7-4)

Figure 7-4 Mass Storage Disk Drive Assembly

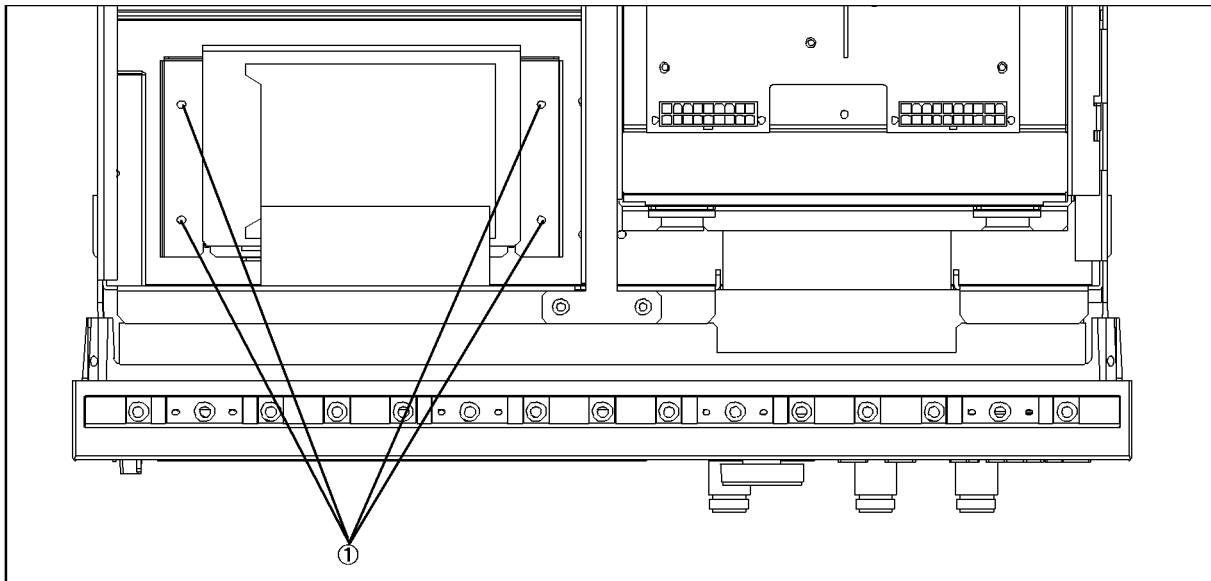

4287 ase07004

- Step 4.** Slide the assembly toward rear side, and lift it.
- Step 5.** Disassemble the mass storage disk drive as shown in Figure 6-11 on page 191.

A28 FDD (Floppy Disk Drive) Removal

Tools Required

- Pozidriv screwdriver, pt size #1 (small)
- Torx screwdriver, T15

Procedure

- Step 1.** Remove the outer cover as described in “Outer Cover Removal”
- Step 1.** Remove the front panel as described in “Front Panel Removal”
- Step 2.** Remove four screws fastening the side panel on the LCD side to the FDD folder.
- Step 3.** Remove four screws fastening the FDD folder to FDD.
- Step 4.** Remove the FDD from the FDD folder.
- Step 5.** Disconnect the mylar ribbon cable (item 7 in Figure 6-2 on page 176) at the FDD.

NOTE

The mylar ribbon cable and their connector are fragile. You must be attentive as described in NOTE on page 231 when you are instructed to disconnect or connect it.

A20 Digital Motherboard Removal (for serial prefix JP1KG, JP2KG, and MY432)

Tools Required

- Pozidriv screwdriver, pt size #1 (small)
- Torx screwdriver, T15

Procedure

- Step 1.** Remove the outer cover as described in “Outer Cover Removal”
- Step 2.** Remove the power supply as described in “A50 Power Supply Assembly Removal (for serial prefix JP1KG, JP2KG, and MY432)”
- Step 3.** Disconnect all cables connected to the digital motherboard.
- Step 4.** Remove all cards from the digital motherboard.
- Step 5.** Remove the CPU fan, CPU, and DIMM64MB.
- Step 6.** Remove seven screws fastening the digital motherboard.

A20 Digital Motherboard Removal (for serial prefix MY433 and later)

Tools Required

- Pozidriv screwdriver, pt size #1 (small)
- Torx screwdriver, T15

Procedure

Step 1. Remove the outer cover as described in “Outer Cover Removal”

Step 2. Remove the power supply as described in “A50 Power Supply Assembly Removal (for serial prefix JP1KG, JP2KG, and MY432)”

Step 3. Disconnect the following cables.

- A26 to A20 Digital Motherboard floppy flat cable (item 1 in Figure 6-14 on page 196)
- A26 to A20 IDE1 flat cable (item 2 in Figure 6-14)
- A26 to LCD mylar ribbon cable (item 4 in Figure 6-14)
- A26 to Floppy mylar ribbon cable (item 6 in Figure 6-14)
- A26 to A27 Mass Storage Disk Drive flat cable (item 7 in Figure 6-14)
- A26 to Backlight primary cable (item 8 in Figure 6-14)
- A21 to the A10 Analog Motherboard flat cable (item 3 in Figure 6-14)
- A21 to the A23 Handler Interface board flat cable (item 5 in Figure 6-14)
- A21 to the A22 Front Panel Keyboard flat cable (item 9 in Figure 6-14)

Step 4. Remove the following boards.

- A21 Analog Interface board as described in “A21 Analog Interface Board Replacement”
- A24 GPIB board as described in “A24 GPIB Card Replacement (for serial prefix MY433 and later)”
- A26 Display board as described in “A26 Display Board Removal (for serial prefix MY433 and later)”

Step 5. Remove five screws fastening the A20 to the bottom panel and remove the A20.

NOTE

To replace the A20, reverse the above procedure. And, configure the several jumpers and BIOS parameters as described in “To Configure the A20 Digital Motherboard and BIOS (for serial prefix MY433 and later)” on page 149.

CPU Replacement (for serial prefix JP1KG, JP2KG, and MY432)

There is a CPU on the A20 Digital Motherboard.

Tools Required

- Flat edge screwdriver

Replacement Procedure

NOTE

Always handle the CPU by the edges, never touch the pins.

- Step 1.** Remove the outer cover as described in “Outer Cover Removal”
- Step 2.** Remove the power supply as described in “A50 Power Supply Assembly Removal (for serial prefix JP1KG, JP2KG, and MY432)”
- Step 3.** Disconnect the CPU fan cable from J16 CPU fan connector.
- Step 4.** Separate the heatsink clip from the CPU socket tabs using the flat edge screwdriver.
- Step 5.** Pull the CPU socket release lever laterally away from the CPU socket to disengage the level from the locking tab. Then rotate the lever upward to release the CPU from the CPU socket.
- Step 6.** Lift the CPU out of the socket.
- Step 7.** To replace the CPU, reverse the CPU removal procedure. Install the CPU so that pin 1 on the CPU aligns with pin 1 of the CPT socket as shown in Figure 7-5. The diagonal notch on the CPU represents pin 1.

Replacement Procedure
CPU Replacement (for serial prefix JP1KG, JP2KG, and MY432)

Figure 7-5

CPU Socket Alignment

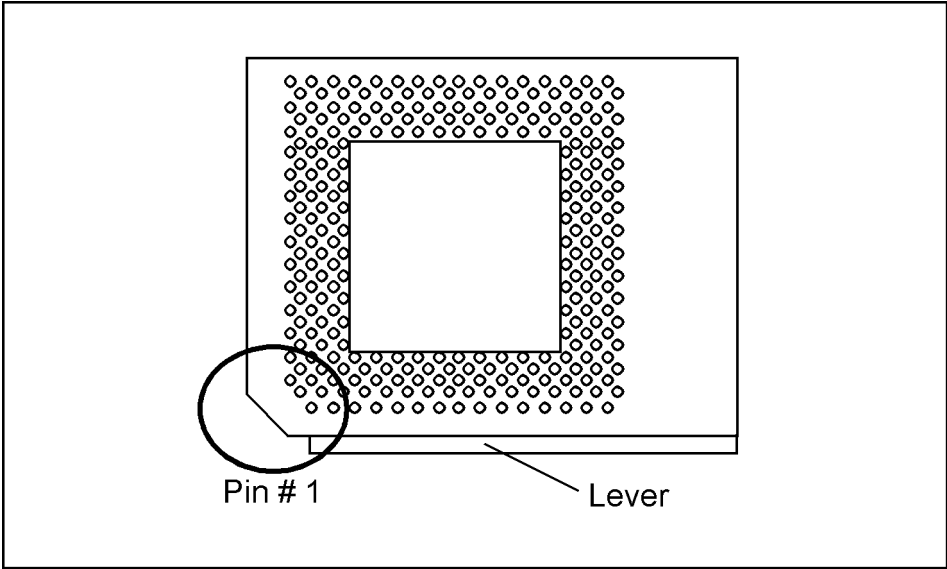

4287ase07005

DIMM64MB Memory Module Removal (for serial prefix JP1KG, JP2KG, and MY432)

There is a DIMM64MB memory on the A20 Digital Motherboard.

Procedure

- Step 1.** Remove the outer cover as described in “Outer Cover Removal”.
- Step 2.** Remove the power supply as described in “A50 Power Supply Assembly Removal (for serial prefix JP1KG, JP2KG, and MY432)”.
- Step 3.** There are three DIMM sockets on the A20. One DIMM memory is installed at the socket U12.
- Step 4.** Cut the cable which ties DIMM memory.
- Step 5.** Unlatch the clips and remove the DIMM memory.
- Step 6.** To replace the DIMM memory, reverse the DIMM Memory Module Removal procedure. Install the DIMM memory in the socket U12 and latch the clips. Tie cable tie with DIMM memory and socket.

A1/A3/A4 Board Removal

Tools Required

- Pozidriv screwdriver, pt size #1 (small) and #2 (medium)
- Open-end wrench, 5/16-inch
- Open-end torque wrench, 5/16-inch (set to 10 in-lb) (for reconnecting SMA connector)

Procedure

- Step 1.** Remove the outer cover as described in “Outer Cover Removal”
- Step 2.** Remove the front frame as described in “Front Panel Removal”
- Step 3.** Disconnect the semi-rigid cables connected to the PC board assembly.
- Step 4.** Remove the two screws fastening the extractor to the chassis.

NOTE

Remove the Nut fastening the BNC connector on the rear panel when A1 board is removed.

- Step 5.** Remove the board using the extractor.

A26 Display/A24 GPIB/A25 LAN/A23 Handler Interface Board Removal (for serial prefix JP1KG, JP2KG, and MY432)

Tools Required

- Torx screwdriver, T15

Procedure

- Step 1.** Remove the outer cover as described in “Outer Cover Removal”
- Step 2.** Remove the cables connected to the board.
- Step 3.** Remove a torx screw fastening the board to the rear panel.
- Step 4.** Remove the card.

A24 GPIB Card Replacement (for serial prefix MY433 and later)

Tools Required

- Pozidriv screwdriver, pt size #2 (medium) (where Pozidriv screws are in use)
- TORX screwdriver, T15, (T10, T20 where TORX screws are in use)

Removal Procedure

Refer to Figure 7-6 for this procedure.

- Step 1.** Remove the outer cover as described in “Outer Cover Removal”.
- Step 2.** Remove the TORX T15 screw (item 1) fastening the card to the rear panel.
- Step 3.** Lift the A24 GPIB Card.

CAUTION

Be careful not to injure the digital mother board and the cable connected the display board to the front assembly.

Figure 7-6 A24 GPIB Card Removal

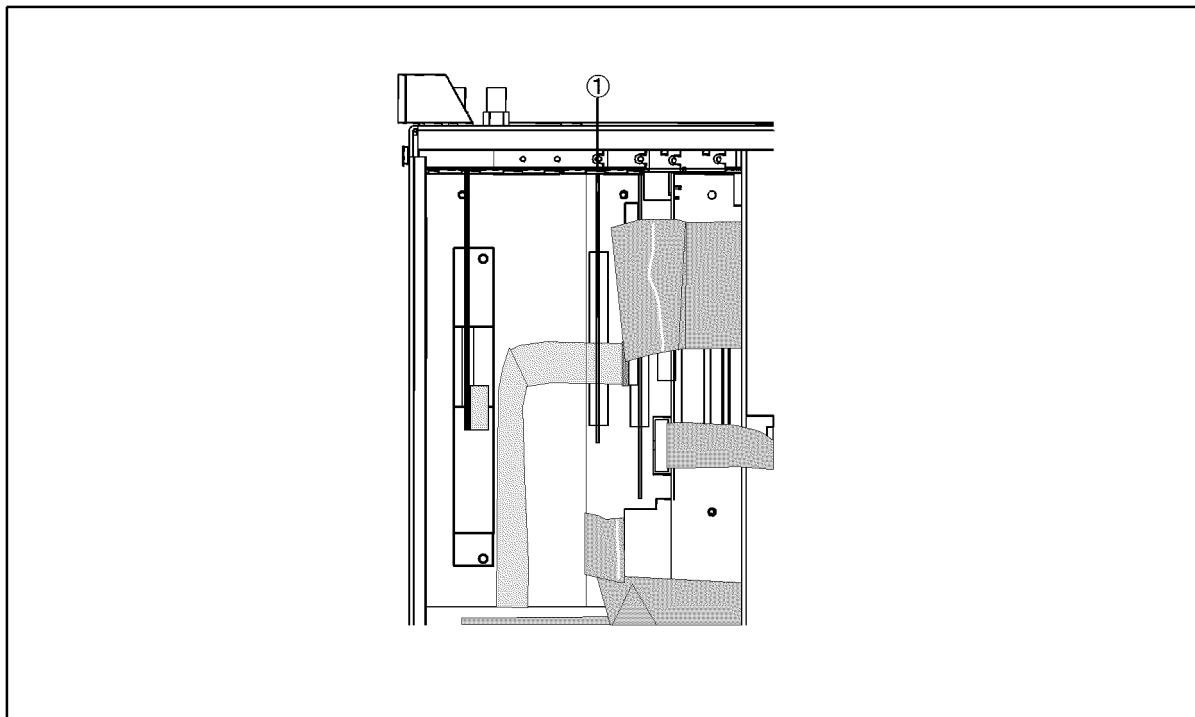

4287ase_004

Replacement Procedure

A24 GPIB Card Replacement (for serial prefix MY433 and later)

Replacement Procedure

- Replace the new A24 GPIB card by inverse procedure of removal.

A26 Display Board Removal (for serial prefix MY433 and later)

Tools Required

- Torx screwdriver, T15

Procedure

- Step 1.** Remove the outer cover as described in “Outer Cover Removal”
- Step 2.** Disconnect the following cables from the A26 Display board.
 - A26 to A20 Digital Motherboard floppy flat cable (item 1 in Figure 6-14 on page 196)
 - A26 to A20 IDE1 flat cable (item 2 in Figure 6-14)
 - A26 to LCD mylar ribbon cable (item 4 in Figure 6-14)
 - A26 to Floppy mylar ribbon cable (item 6 in Figure 6-14)
 - A26 to A27 Mass Storage Disk Drive flat cable (item 7 in Figure 6-14)
 - A26 to Backlight primary cable (item 8 in Figure 6-14)
- Step 3.** Remove a torx screw fastening the A26 to the rear panel.
- Step 4.** Remove the A26.

NOTE

Use the following procedure when you handle the mylar ribbon cable. The mylar cable and their connector are very fragile. To replace to a new mylar cable is recommended when you are instructed to disconnect and connect the mylar cable frequently.

To disconnect the cable:

- Step 1.** Pry up the retainer slightly at either end of the connector as swown in Figure 7-7, using a small flat-blade screwdriver.

Figure 7-7

pry up the retainer

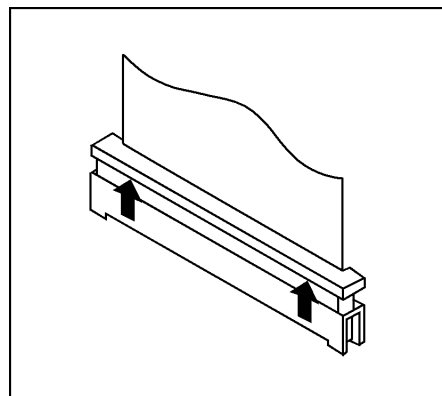

4287ase07007

Replacement Procedure
A51 LCD Removal

Step 2. Pull the mylar ribbon cable out of the connector.

A51 LCD Removal

Tools Required

- Pozidriv screwdriver, pt size #1 (small) and #2 (medium)

Procedure

Step 1. Remove the front panel as described in “Front Panel Removal”.

Step 2. Remove six screws from the LCD cover.

Step 3. Disconnect two wire assemblies from the inverter.

Step 4. Remove four screws from the LCD.

Step 5. Remove the flat cable from the LCD.

A21 Analog Interface Board Replacement

Tools Required

- PLCC extractor
- Torx screwdriver, T15

Removal Procedure

- Step 1.** Remove the outer cover as described in “Outer Cover Removal”.
- Step 2.** Disconnect all cables from the analog interface board.
- Step 3.** Remove the analog interface board with a torx screwdriver.
- Step 4.** Remove the EEPROM from the original board, then mount it on the new board.

Figure 7-8 EEPROM

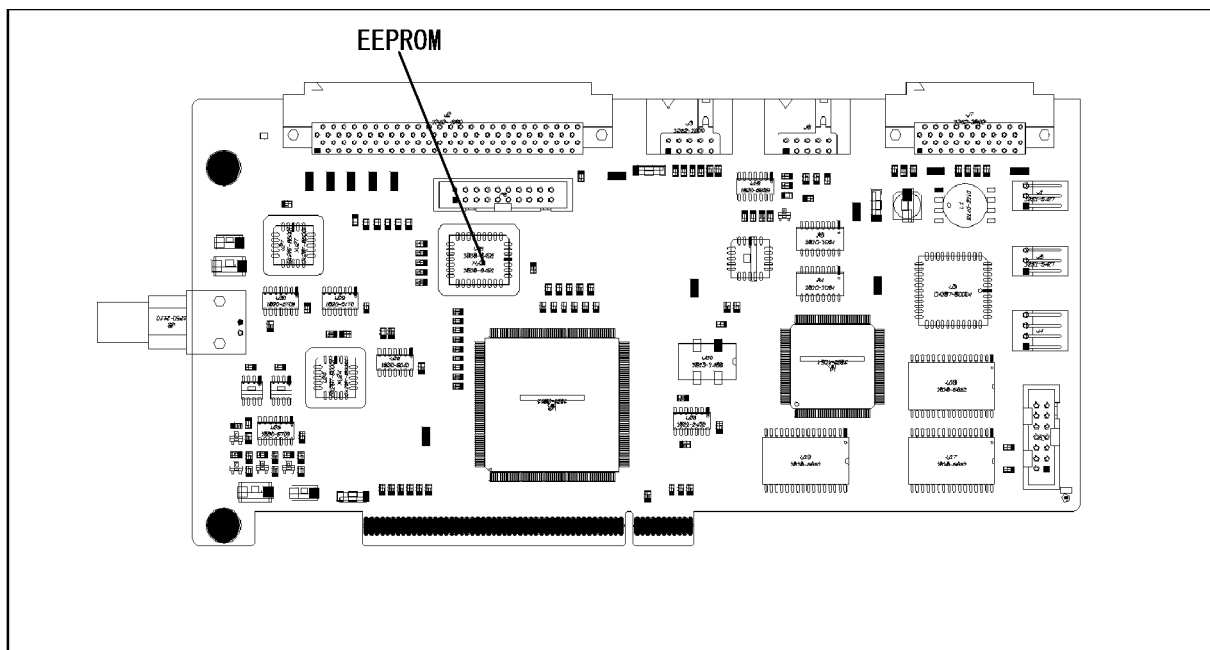

4287ase07002

A23 Handler Interface Board Removal

Tools Required

- Pozidriv screwdriver, pt size #1 (small) and #2 (medium)
- Torx screwdriver, T15

Procedure

- Step 1.** Remove the outer cover as described in “Outer Cover Removal”
- Step 2.** Disconnect the A23 Handler Interface board to A21 Analog Interface board flat cable.
- Step 3.** Remove the two screws fastening the A23 to the rear panel.
- Step 4.** Remove the A23.

8**Post-Repair Procedures**

This chapter lists the procedures required to adjust and verify the 4287A operation after an assembly is replaced with a new one.

Post-Repair Procedures

Table 8-1 *Post Repair Procedures* lists the required procedures that must be performed after the replacement of an assembly, CPU, DIMM64MB (Memory) or the EEPROM. These are the recommended minimum procedures to ensure that the replacement is successfully completed.

Table 8-1 Post-Repair Procedures

Replaced Assembly or Part	Adjustments Correction Constants (CC)	Verification
A1 Reference Oscillator Board	A1 VCXO Frequency Adjustment A3 Local Level Adjustment A3 Output AGC Gain Adjustment A3 Output Level Adjustment A4 Local AGC Gain Adjustment A4 Local level Adjustment A4 IF Local AGC Gain Adjustment	“To Execute Internal Test” on page 117 Frequency Accuracy Test Power Level Accuracy Test Impedance Measurement Accuracy Test
A3 Source Board	A3 Local Level Adjustment A3 Output AGC Gain Adjustment A3 Output Level Adjustment A4 Local AGC Gain Adjustment A4 Local level Adjustment A4 IF Local AGC Gain Adjustment	“To Execute Internal Test” on page 117 Frequency Accuracy Test Power Level Accuracy Test Impedance Measurement Accuracy Test
A4 Receiver Board	A4 Local AGC Gain Adjustment A4 Local level Adjustment A4 IF Local AGC Gain Adjustment A4 RF Gain Adjustment A4 DC Gain Adjustment	“To Execute Internal Test” on page 117 Impedance Measurement Accuracy Test DC Resistance Measurement Accuracy Test
A6 Test Head Board	A3 Output Level Adjustment A4 IF Gain Adjustment	Power Level Accuracy Test Impedance Measurement Accuracy Test DC Resistance Measurement Accuracy Test
A10 Analog Motherboard	Not Required	Inspect the Booting Process When symptom of failure is out of specification, perform the performance test.
A20 Digital Motherboard	Set jumpers and BIOS parameters on the A20. For details, see “Configure the Motherboard” on page 137 and “To Confirm or Set the BIOS Options” on page 139.	Inspect the Booting Process
A21 Analog Interface Board	Not Required	Inspect the Booting Process “To check the Front Panel” on page 123 “To check the External Trigger Input” on page 125

Table 8-1 Post-Repair Procedures

Replaced Assembly or Part	Adjustments Correction Constants (CC)	Verification
A22 Front Panel Keyboard	Not Required	“To check the Front Panel” on page 123
A23 Handler Interface Board	Not Required	“To check the Handler Interface” on page 130
A24 GPIB Board	Not Required	“To check the GPIB” on page 131
A25 LAN Interface Board	Not Required	“To check the LAN (for serial prefix JP1KG, JP2KG, and MY432)” on page 125
A26 Display Board	Not Required	Inspect the Booting Process “To check the VGA Display Output” on page 125
A27 Mass Storage Disk Drive	Install the latest firmware, if it is not installed in the mass storage disk drive.	Inspect the Booting Process
A28 FDD	Not Required	“To check the FDD” on page 124
A50 Power Supply Assembly	Not Required	Inspect the Booting Process
A51 LCD	Not Required	Inspect the Booting Process “To check the LCD and Back Light” on page 123
A52 Inverter Board	Not Required	Inspect the Booting Process “To check the LCD and Back Light” on page 123
CPU 233MHz	Not Required	Inspect the Booting Process
DIMM 64Mbyte	Not Required	Inspect the Booting Process
EEPROM on the A21	SysCal Initialize A1 VCXO Frequency Adjustment A3 Local Level Adjustment A3 Output AGC Gain Adjustment A3 Output Level Adjustment A4 Local AGC Gain Adjustment A4 Local level Adjustment A4 IF Local AGC Gain Adjustment	Inspect the Booting Process

Post-Repair Procedures
Post-Repair Procedures

A **Manual Changes**

This appendix contains the information required to adapt this manual to versions or configurations of the 4287A manufactured earlier than the current printing date of this manual. The information in this manual applies directly to 4287A units with the serial number that is printed on the title page of this manual.

Manual Changes

To adapt this manual to your 4287A, refer to Table A-1 and Table A-2.

Table A-1 Manual Changes by Serial Number

Serial Prefix or Number	Make Manual Changes

Table A-2 Manual Changes by Firmware Version

Version	Make Manual Changes

Agilent Technologies uses a two-part, ten-character serial number that is stamped on the serial number plate (Figure A-1). The first five characters are the serial prefix and the last five digits are the suffix.

Figure A-1 Serial Number Plate (Example)



4287aoj1101

B System Installation for A27 Mass Storage

This appendix describes how to install the operation system to the A27 mass storage. When the operating system in the A27 mass storage has damage, you can recovery it before replacing the A27 by this procedure.

System Installation for A27 Mass Storage (for serial number JP1KG and A27 that has never been replaced)

The operating system is able to be installed to the A27 Mass Storage from your external Personal Computer via LAN. To enable the LAN installation, you must configure server (your Personal Computer). However, the 4287A firmware and user files are unable to be installed to it by only performing the system installation. Install these files for reference to Appendix C, "Firmware Installation," on page 273 and Appendix D, "Back-up User Files in A27 Mass Storage," on page 279 after system installation.

In addition, only Agilent personnel is allowed to install the operating system.

Required Parts

- Personal Computer
 - CPU: Intel Pentium
 - RAM: 64 MB Memory
 - Other Hardware: Floppy Disk Drive (FDD), CD-ROM Drive, and LAN interface.
 - OS: Windows 95/98 or Windows NT
- LAN cable (Cross cable)
- 4287A Service CD-ROM*¹
- Floppy Disk (2HD, 1 ea.)

System Installation Procedure

To install the system into the 4287A, following procedure is required. For detail procedure, refer to below sections.

1. Making a Recovery System Disk
2. Configure the LAN protocols on your personal computer
3. LAN Cable Connection
4. Change 1st boot device using the 4287A BIOS setup utility
5. Install the 4287A operating system
6. Boot the 4287A from A27 mass storage unit

Making a Recovery System Disk

First of all, it is necessary to prepare the recovery system disk using your personal computer. The following is a procedure of making the recovery system disk.

Step 1. Insert the 4287A service CD-ROM into the CD-ROM drive on your personal computer.

Step 2. Run Command Prompt by the following mouse procedure on the personal computer.

Start - Programs - Command Prompt

*1. This part is not assigned a part number. If you need it, contact to CTU-Kobe service support.

System Installation for A27 Mass Storage

System Installation for A27 Mass Storage (for serial number JP1KG and A27 that has never been replaced)

- Step 3.** Change current directory to the following directory in the Command Prompt window.
- d:\4287ARecovery\Bootdisk (The left 'd' is a drive name of the CD-ROM drive. If another drive name is assigned to CD-ROM drive, specified drive name instead of 'd')
- Step 4.** Insert the new floppy disk into the FDD on the personal computer.
- Step 5.** Run “Copydisk.exe disk1.bin a:” in the Command Prompt window. Copying a disk image files to floppy disk takes about one minute.
- Step 6.** Remove a floppy disk. Write “4287A Recovery System Disk” to label on the floppy disk.

System Installation for A27 Mass Storage

System Installation for A27 Mass Storage (for serial number JP1KG and A27 that has never been replaced)

Configuration of the LAN protocol on your personal computer (Windows 95/98)

Next, it is necessary to configure the LAN protocol on your personal computer. The following is a procedure of the LAN configuration on the windows 95/98 based personal computer. If windows NT is installed in your personal computer, ignore this section and refer to “Configuration of the LAN protocol on your personal computer (Windows NT)” on page 248.

Step 1. Open the “Network” dialog box by the following mouse procedure.

Start - Settings - Control Panel - Network

Step 2. When “NetBEUI” protocol is not installed in the “Network” dialog box, add it by the following mouse procedure.

Add... - Protocol - Manufactures:Microsoft - Network Protocols:NetBEUI - OK

Step 3. When “File and printer sharing for Microsoft Networks” service is not installed in the “Network” dialog box, add it by the following procedure.

Add... - Service - File and printer sharing for Microsoft Networks - OK

Step 4. Make sure that “NetBEUI” protocol and “File and printer sharing for Microsoft Networks” service are installed for reference to Figure B-1.

Figure B-1

Network Configuration

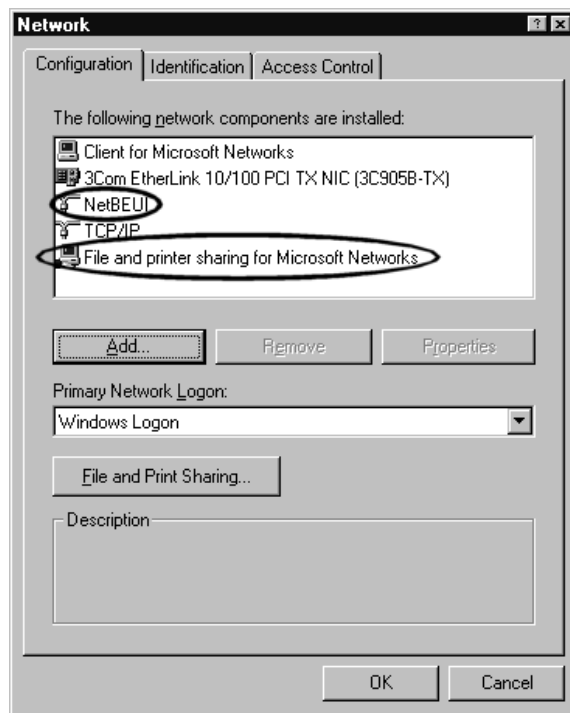

Step 5. Enable the File sharing by the following mouse procedure.

File and printer Sharing... - I want to be able to give others access to my file - OK

Figure B-2

File and Printer Sharing



Step 6. Click **Identification** tag, then computer name such a Figure B-3 is displayed. Read the computer name. In the following example case, computer name is “kobedtc11”. If it is not assigned yet, assign it.

Figure B-3

Computer Name

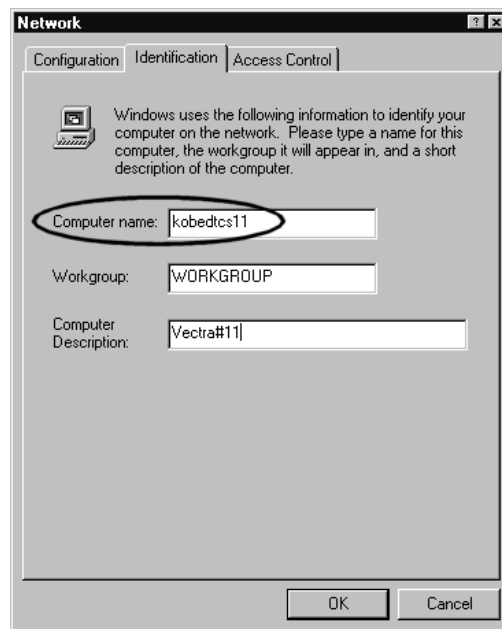

System Installation for A27 Mass Storage

System Installation for A27 Mass Storage (for serial number JP1KG and A27 that has never been replaced)

Step 7. Next, insert the 4287A Service CD-ROM into the CD-ROM drive. Run Windows Explorer by the following mouse procedure.

Start - Programs - Windows Explorer

Display the “\\4287ARecovery\image” folder in the 4287A Service CD-ROM such as Figure B-4.

Figure B-4

Service CD-ROM folder structure

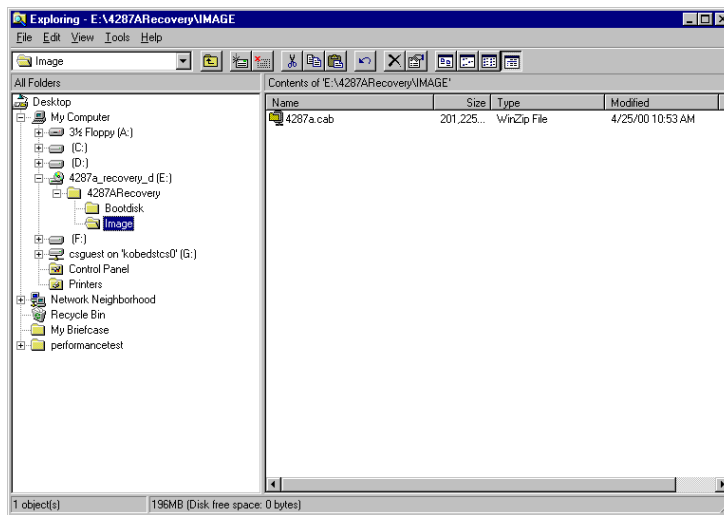

- Step 8.** Right mouse click “\\4287ARecovery\Image” folder, then shortcut menu is displayed. Next, click **Sharing...**, then “Image Properties” dialog box is displayed such a Figure B-5.

Figure B-5

Image Properties

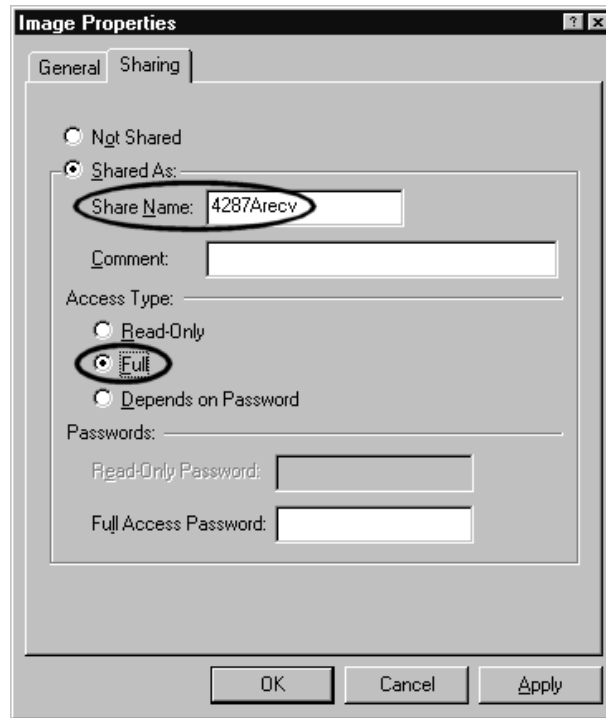

- Step 9.** Input “4287Arecv” to a share name and access type to “Full” with no password for reference to Figure B-5.

System Installation for A27 Mass Storage

System Installation for A27 Mass Storage (for serial number JP1KG and A27 that has never been replaced)

Configuration of the LAN protocol on your personal computer (Windows NT)

It is necessary to configure the LAN protocol on your personal computer. The following is a procedure of the LAN configuration on the windows NT. If windows 95/98 is installed in your personal computer, ignore this section and refer to “Configuration of the LAN protocol on your personal computer (Windows 95/98)” on page 244.

Step 1. Open the “Network” dialog box by the following mouse procedure.

Start - Settings - Control Panel - Network

And, click **Protocol** tag. Then Figure B-6 is displayed.

Figure B-6

Protocol Setting

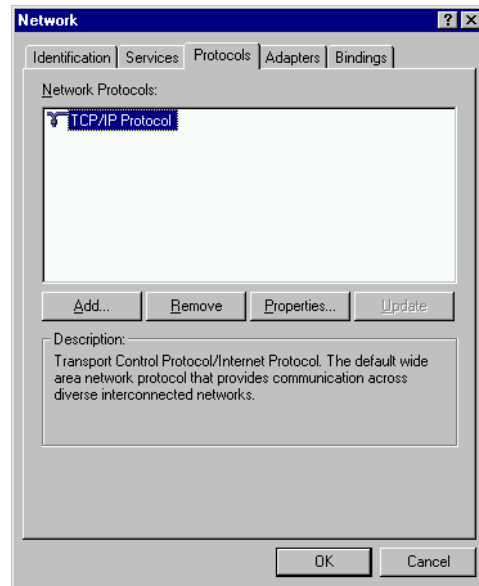

Step 2. When “NetBEUI” protocol is not installed in the “Network” dialog box, click **Add...** Then Figure B-7 is displayed.

Select the “NetBEUI Protocol” and click **OK**. Then “NetBEUI” protocol is added in the network protocol.

Figure B-7 Select Network Protocol

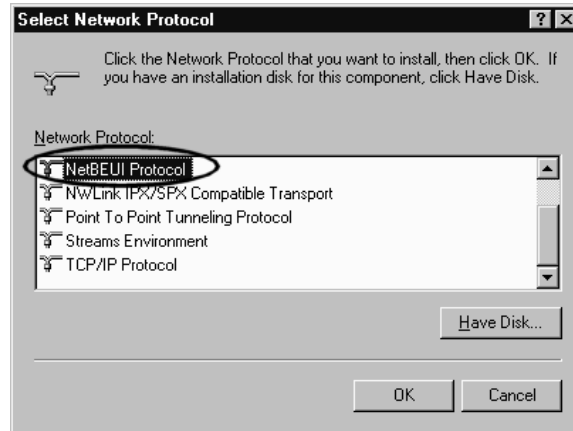

Step 3. Click **Service** tag, Then Figure B-8 is displayed.

Figure B-8 Service Setting

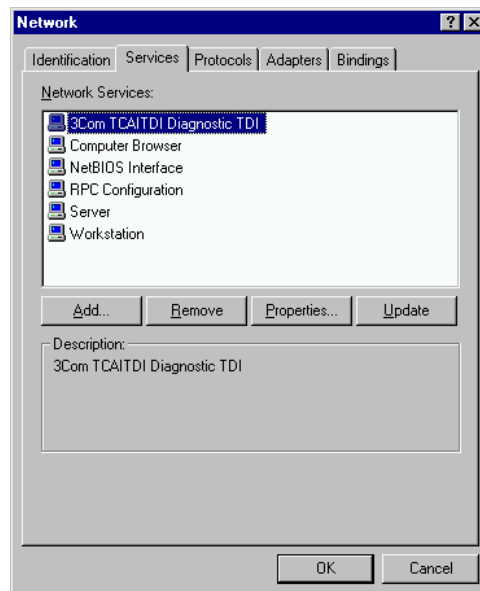

Step 4. When “Server” service is not installed in the “Network” dialog box, click **Add...**. Then Figure B-9 is displayed.

Select the “Server” and click **OK**. Then “Server” service is added in the network protocol.

Figure B-9

Select Network Service

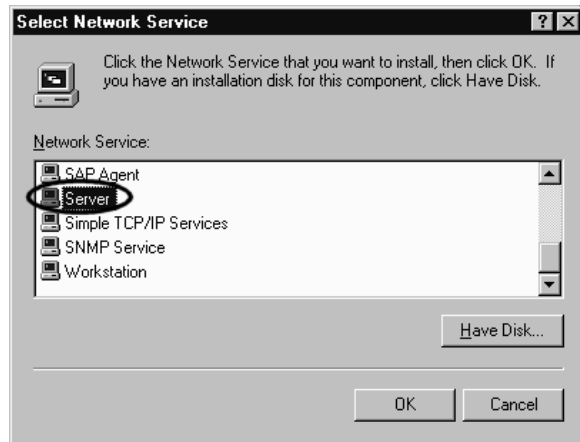

Step 5. Click **Identification** tag, then computer name such as Figure B-10 is displayed. Read the computer name. In the following example case, computer name is “kobedtcs9”. If it is not assigned yet, assign it.

Figure B-10

Computer Name

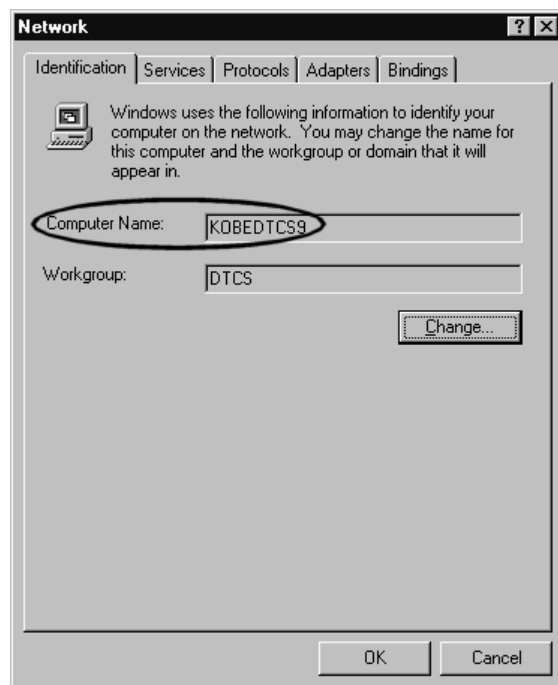

System Installation for A27 Mass Storage (for serial number JP1KG and A27 that has never been replaced)

Step 6. Next, insert the 4287A Service CD-ROM into the CD-ROM drive. Run Windows Explorer by the following mouse procedure.

Start - Programs - Windows NT Explorer

Display the “\\4287ARecovery\Image” folder in the 4287A Service CD-ROM such as Figure B-11.

Figure B-11

Service CD-ROM folder structure

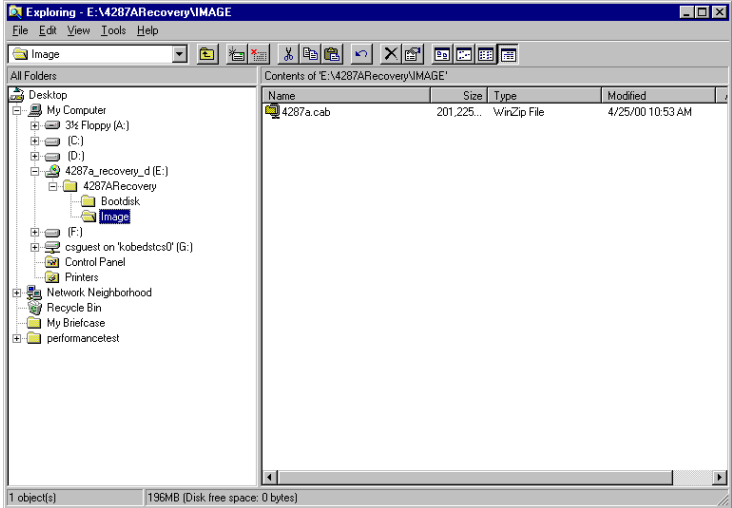

Step 7. Right mouse click “\\4287ARecovery\Image” folder, then shortcut menu is displayed. Next, click **Sharing...**, then “Image Properties” dialog box is displayed such as Figure B-12.

Figure B-12

Image Properties

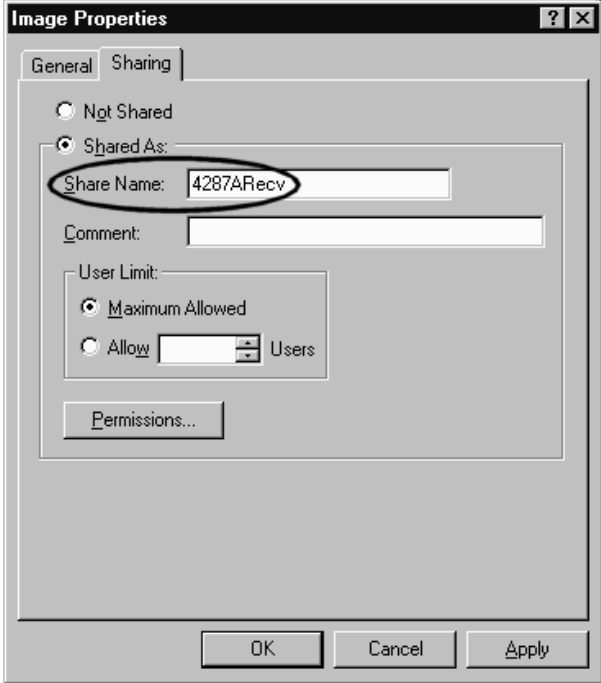

Step 8. Input “4287ARecv” to a share name and click **Permissions...**, then Figure B-13 is displayed. Select “Guests” and Click **Add...**, then “Guests” is added in the Add Names. Next, change Type of Access to “Full Control” and click **OK**.

Figure B-13

Add Users and Groups

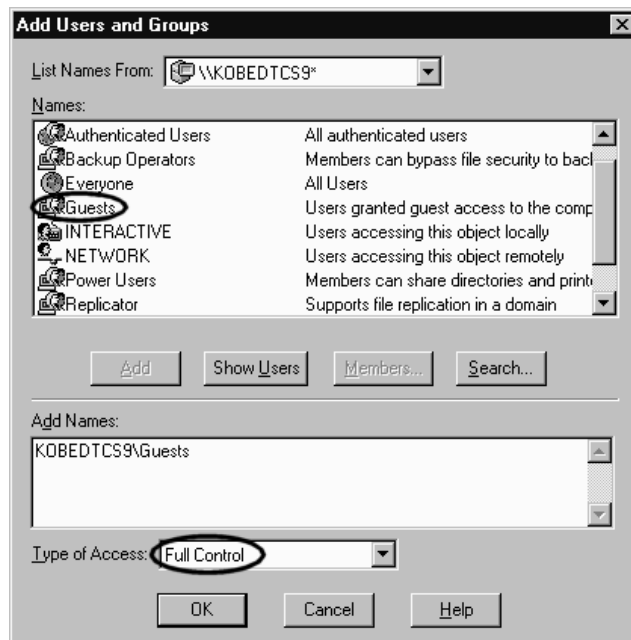

Step 9. Figure B-14 is displayed. Make sure that the type of access of the Guests is set to “Full Control”. If ok, click **OK**.

Figure B-14

Access Through Share Permissions

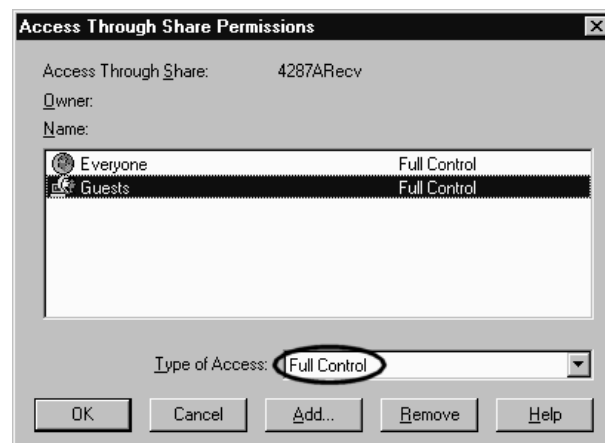

LAN cable connection

Connect a crossed LAN cable between the server (your personal computer) and the client (4287A) directly as shown in Figure B-15.

Figure B-15 LAN connection with cross cable

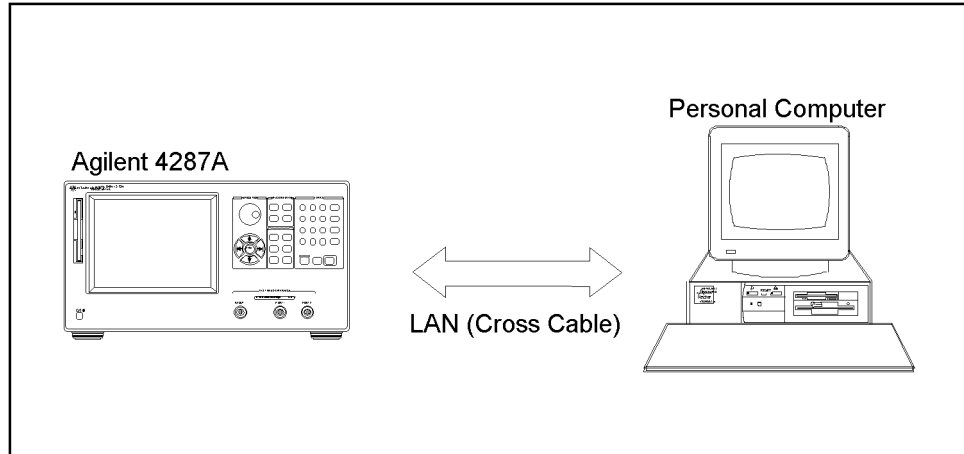

4287ase04032

If you don't have the crossed LAN cable, it is available to connect a straight LAN cable between server and client via multiport Hub as shown in Figure B-16.

Figure B-16 LAN connection with straight cables

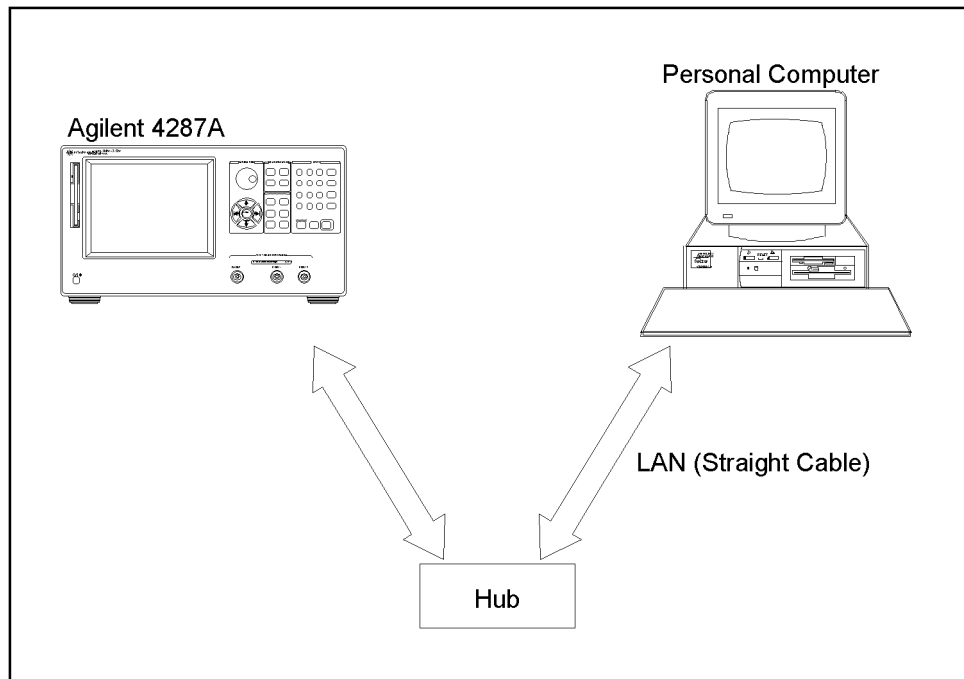

4287ase04033

System Installation for A27 Mass Storage

System Installation for A27 Mass Storage (for serial number JP1KG and A27 that has never beep replaced)

Change 1st Boot device using the 4287A BIOS setup utility

Usually, the 4287A 1st boot device in the BIOS setup utility is set to “1st IDE-HDD”. To recover the operating system is necessary to boot the 4287A from the floppy disk. The following is a procedure of the changing a 1st boot device.

- Step 1.** Connect the mouse and the keyboard to the 4287A rear panel. Then turn the 4287A on.
- Step 2.** Hit **[Delete]** key as soon as the message of “Hit DEL if you want to run SETUP” is displayed.
- Step 3.** Enter password as “kid” when you are required it. Then BIOS setup utility screen is displayed.
- Step 4.** Move the cursor to “Advanced CMOS Setup” using **[↑]**, **[↓]** keys and hit **[Enter]** key. Then ADVANCED CMOS SETUP screen is displayed.
- Step 5.** Move the cursor to “1st Boot Device” using **[↑]**, **[↓]** keys. Change the 1st boot device from “1st IDE-HDD” to “Floppy” using **[+]**/**[-]** keys.
- Step 6.** hit **[Esc]** key, then BIOS setup utility main menu is displayed again.
- Step 7.** Move the cursor to “Save Settings and Exit”, and hit **[Enter]** key. When “Save current settings and exit (Y/N) ?” is displayed, hit **[Y]**, **[Enter]** keys. Then, the 4287A will shutdown automatically.

Install the 4287A operating system

The following is a procedure of extracting the 4287A image file from CD-ROM to A27 mass storage unit via LAN.

- Step 1.** Connect the mouse and the keyboard to the 4287A rear panel, if they are not connected.
- Step 2.** Inset the 4287A recovery system disk you made into your personal computer FDD. And open a Server.bat file using Notepad which is exist at the root folder. A contents of the Server.bat file is as follows;

```
@echo off
rem
rem Please set SERVER_NAME and SHARE_NAME in a:\server.bat
rem For example, if 4287A disk image file exists at
rem \\pc3456\image_dir\ then
rem
rem set SERVER_NAME=pc3456
rem set SHARE_NAME=image_dir
rem

set SERVER_NAME=
set SHARE_NAME=
```

System Installation for A27 Mass Storage
**System Installation for A27 Mass Storage (for serial number JP1KG and A27
that has never been replaced)**

- Step 3.** Edit a computer name of the server and share name of the Image folder as follows. For detail of the computer name and share name, refer to step 6 on page 245 and step 9 on page 247, if Windows 95/98 is installed into your personal computer. For detail of them, refer to step 5 on page 250 and step 8 on page 252, if Windows NT is installed into your personal computer.

Example B-1 **Server (computer) name and share name**

```
set SERVER_NAME=kobedtcsl1  
set SHARE_NAME=4287Arecv
```

- Step 4.** Inset the 4287A recovery system disk you made into the 4287A FDD.
- Step 5.** Inset the 4287A Service CD-ROM into your personal computer.
- Step 6.** Turn the 4287A on, then system installation will start automatically.
- Step 7.** Then Figure B-17 is displayed. Select “3. Format A27 mass storage unit and download image files.” using [↑], [↓] key and hit [Enter] key.

Figure B-17 **Menu screen**

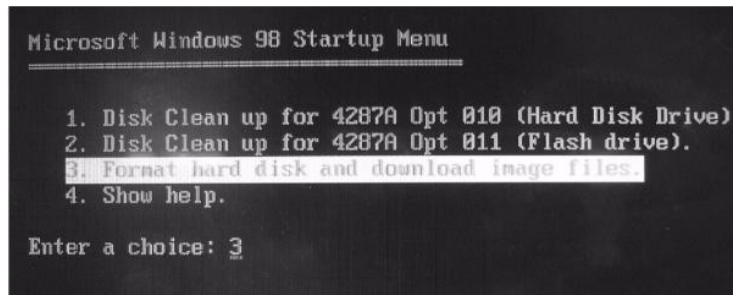

- Step 8.** Then formatting the C drive and D drive will start automatically first. After disk formatting, extracting 4287A image file to the A27 mass storage unit. It takes about 5 to 30 minutes.
- Step 9.** A message of “Remove floppy disk and restart 4287A” is displayed as soon as extracting 4287A image file completes.

Boot the 4287A from the A27 mass storage unit

The following is a procedure of booting the 4287A from A27 mass storage unit which is installed the operating system.

- Step 1.** Connect the mouse and the keyboard to the 4287A rear panel, if they are not connected.
- Step 2.** Turn the 4287A on, and change the 1st boot device from “Floppy” to “1st IDE-HDD” using BIOS setup utility. Refer to “Change 1st Boot device using the 4287A BIOS setup utility” on page 254, if you want to know how to change the 1st boot device.
- Step 3.** Turn the 4287A again, booting the operating system start from the A27 mass storage unit automatically.
- Step 4.** Detecting a new hardware device start in the booting process once. If appropriate device driver is missing, installing the device driver is required from another drive such a floppy disk. We will provide a device driver individually which is not included in the 4287A service CD-ROM.

System Installation for A27 Mass Storage

System Recovery (for serial number JP2KG, MY432 or JP1KG with its A24 has been replaced by 04287-61031/-61032)

- Step 5.** When Windows desktop screen is displayed without problem, install the 4287A firmware. For detail, refer to Appendix C, “Firmware Installation,” on page 273.
- Step 6.** Recover the 4287A user files you take a back-up. For detail, refer to Appendix D, “Back-up User Files in A27 Mass Storage,” on page 279.
- Step 7.** Double-click “My Computer” icon. Then the 4287A instrument screen is displayed.
- Step 8.** Change the 4287A mode to the Instrument Mode by the following procedure.
- Hit **[System]** key on the 4287A front panel, and click **SERVICE MENU, MISC MENU, SHUTDOWN AS INSTR** softkeys.
- Step 9.** Enter password as “kid”, then click **OK**. The 4287A will shutdown automatically.
- Step 10.** It is able to reboot the 4287A properly from next time.

System Recovery (for serial number JP2KG, MY432 or JP1KG with its A24 has been replaced by 04287-61031/-61032)

The 4287A has a backup file in the H drive(Hidden Drive) of the A27 mass storage which includes a compression image of the system files, application files, and calibration constant data. You can recover these files using the following procedure when the operating system in the A27 mass storage has damage.

NOTE

There are two types of the system recovery. This section describes the procedure for each system recovery.

- Procedure for the E4991As that have serial number prefixed JP1KH and their A27 mass storage has never been replaced.
- Procedure for the E4991As that do not have serial number prefixed JP1KH or their A27 mass storage has been replaced.

Notes on executing system recovery

Performing system recovery causes the following:

- The following settings of the 4287A are initialized.
 - Network settings
 - GPIB settings
- If the firmware has been updated after purchasing the 4287A, the firmware when you purchased the product^{*1} is recovered.

Files you created using the save function are not affected, but we recommend backing them

*1.If the hard disk failed and has been replaced after purchase, the state when the replacement was performed is recovered.

up before executing system recovery for precautionary purposes.

NOTE

If the 4287A is turned off without shutdown process, Microsoft Scandisk runs after 4287A logo is displayed. If serious trouble is found during the scan disk, reinstall the operating system. And if the operating system still doesn't boot properly after reinstallation, A27 has to be replaced physically.

And, if you encounter the following problems, try to reinstall the operating system before replacing the A27.

- “xxx file is missing” is displayed on the DOS screen.
- The 4287A logo screen is not displayed after “Searching for Boot Record from IDE-0 .. OK” is displayed.
- Windows always boots with Safe Mode.

Procedure to execute system recovery

- Step 1.** Shut down the 4287A.
- Step 2.** Connect the external keyboard to the 4287A.
- Step 3.** Press the standby switch of the 4287A to turn it on.
- Step 4.** When the message in the figure below appears on the screen following the Agilent's logo screen, immediately press **[R]** on the keyboard.

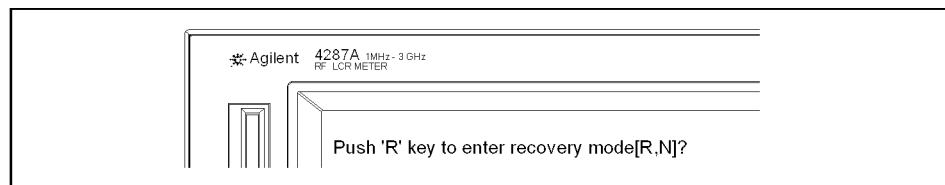

4287ase5001

NOTE

Watch the message carefully because after several seconds it will be replaced with the next screen. Note that this is automatically done with no key operations.

- Step 5.** When "Recover Hard disk (C drive) [Y, N]?" is displayed, press **[Y]** on the keyboard. If you want to quit the system recovery, press **[N]** to start up the 4287A as usual.
- Step 6.** The following message appears. This is the final confirmation message asking whether you want to start the system recover. Press **[Y]** on the keyboard to start the system recovery. If you want to quit the system recovery, press **[N]** to start up the 4287A as usual.

```
=====  
SYSTEM RECOVERY  
=====
```

This process will recover the system drive (C:) of this instrument to the factory-shipment state. It takes about 10 minutes. Please refer to the Operation Manual for more information.

This is the last chance to quit the recovery process

System Installation for A27 Mass Storage
**System Recovery (for serial number JP2KG, MY432 or JP1KG with its A24
has been replaced by 04287-61031/-61032)**

Continue [Y,N]?

Step 7. The system recovery will be completed in about 10 minutes. The following message is displayed during the system recovery.

```
=====  
SYSTEM RECOVERY IN PROGRESS...  
=====
```

```
System recovery in progress. It takes about 10 minutes.  
Please DO NOT TURN THE POWER OFF DURING THIS TIME.
```

CAUTION

Never turn off the power during the system recovery because doing so may cause serious damage to the 4287A.

Step 8. When the system recovery is completed, the following message appears below the above message indicating that the system recovery is in progress.

```
"Recovery Completed !"  
"Please any key and then restart system."
```

Now the system recovery of the 4287A is complete.

System Recovery (for serial prefix MY433 and later)

By executing system recovery, you can return the system of the 4287A (the Windows operating system and the firmware) to the factory state (at the time of purchase^{*1}).

Types of system recoveries

The following two types of system recoveries are available.

Factory recovery

Returns the contents of the C drive to the factory state.

User recovery^{*2}

Returns the contents of the C drive to a user-specified state. To use this function, you must prepare for recovery in advance. For information on preparation, see “Procedure to create the user backup image” on page 263 for information on the execution. Also, see “Procedure to execute the user recovery function” on page 266.

Notes on executing system recovery

Executing system recovery causes the following:

In addition to the Windows operating system and the firmware, the following settings of the 4287A are returned to the factory state.

- Network setting
- GPIB setting
- Printer setting

The driver for the supported printer installed after purchase is deleted.

You need to execute initial registration again.

Files you created using the save function (files in the D drive) are not affected, but we recommend backing them up before executing system recovery for precautionary purposes. For more information on backup, refer to “Making Backup Files” as described in 4287A User’s Guide.

*1. If the hard disk failed and has been replaced after purchase, the state when the replacement was performed is recovered.

*2. This function is available when the volume label on the hard disk is IZ202 or higher.

System Installation for A27 Mass Storage
System Recovery (for serial prefix MY433 and later)

Procedure to execute system recovery

NOTE You need the keyboard for this operation.

Step 1. Shut down the 4287A.

Step 2. Connect the keyboard to the 4287A.

Step 3. Insert the disk for the system recovery which is furnished with the 4287A into the floppy disk drive of the 4287A.

Step 4. Press the standby switch of the 4287A to turn it on.

Step 5. When the screen as shown in the figure below appears, press and hold  of the keyboard until this screen disappears.

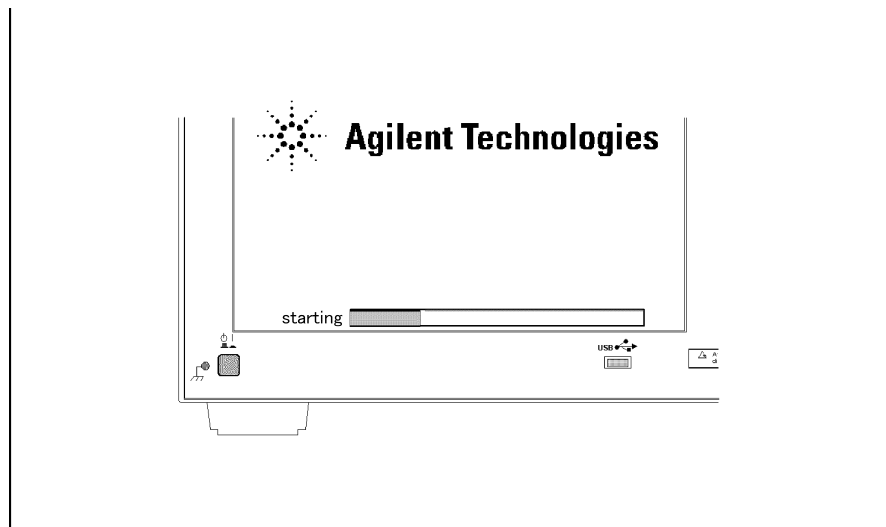

e5061buj034

NOTE After several seconds, the next screen appears automatically even if you do not press any key, so do not miss it.

If the above message does not appear, the instrument is at fault; contact your local Agilent customer center listed at the end of this manual or distributor.

Step 6. The following screen appears. Select “+Removable Devices” with of the keyboard, and press of the keyboard.

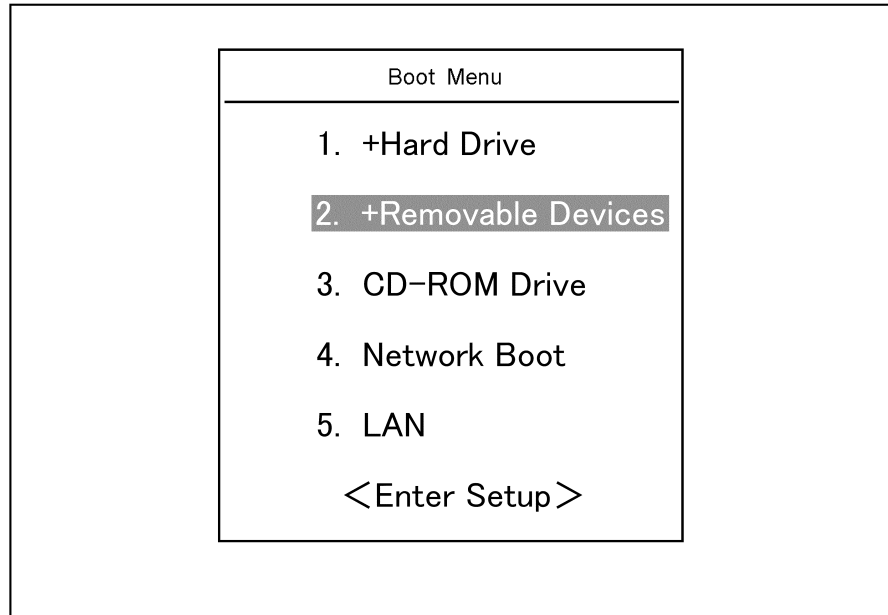

Step 7. The message as shown below appears. Press of the keyboard. If you want to cancel the factory recovery, press here.

```

Agilent Technologies System Utilities
Recovery & Backup Options

```

Choose One of the following:

-
1. Recover Factory Backup Image
 2. Create User Backup Image
 3. Recover User Backup Image
 4. Exit
-

Enter a Choice: _

NOTE

If the above message does not appear, the instrument or the disk for the system recovery is at fault; contact your local Agilent customer center listed at the end of this manual or distributor.

System Installation for A27 Mass Storage System Recovery (for serial prefix MY433 and later)

- Step 8.** The message as shown below appears. Press **C** of the keyboard. If you want to cancel the system recovery, press **E** here.

You chose to Restore your system by installing the original factory installed OS and system software.

WARNING: Press C to Continue only if you are sure that you want to proceed. The C: Drive will be completely overwritten with no chance of recovering any data. Use Option 1 to recover the system from a serious malfunction caused by corrupted or inadvertently deleted files on the system's primary C: partition.

Press C to Continue or E to Exit: _

- Step 9.** The message as shown below appears. Press **C** of the keyboard to start the factory recovery. If you want to cancel the factory recovery, press **E** here.

CAUTION! Interrupting this process may leave the system in an unstable state. Allow the software to complete the backup and recovery process. This may take up to 20 minutes depending on the system configuration.

Press C to Continue or E to Exit: _

CAUTION

Never turn off the power during the factory recovery because doing so may cause serious damage to the 4287A.

- Step 10.** The factory recovery will be complete in about 5 minutes. When the factory recovery is complete, the message as shown below appears. Press **Ctrl**, **Alt**, and **Del** of the keyboard at the same time to restart.

Remove the disk and Press CLT+ALT+DEL to restart your system.

NOTE

If the above message does not appear, the instrument is at fault; contact your local Agilent customer center listed at the end of this manual or distributor.

- Step 11.** After restart, the screen for initial registration appears. Execute initial registration. For information on the execution procedure, refer to "Initial Registration of 4287A (for serial prefix MY433 and later)" on page 269.

Procedure to create the user backup image

This section describes how to create the user backup image. The C drive contents saved in this creation are recalled when the user recovery function is executed.

NOTE This function is available when the volume label on the hard disk is IZ202 or higher.

NOTE You need the keyboard for this operation.

- Step 1.** Shut down the 4287A.
- Step 2.** Connect the keyboard to the 4287A.
- Step 3.** Insert the disk for the system recovery into the floppy disk drive of the 4287A.
- Step 4.** Press the standby switch of the 4287A to turn it on.
- Step 5.** When the screen as shown in the figure below appears, press and hold  of the keyboard until this screen disappears.

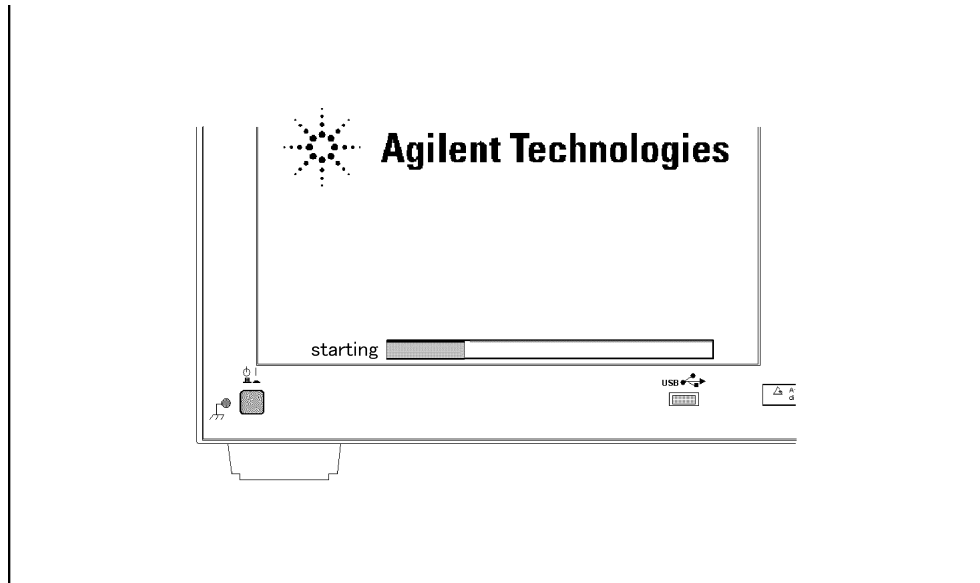

e5061buj034

NOTE After several seconds, the next screen appears automatically even if you do not press any key, so do not miss it.

If the above message does not appear, the instrument is at fault; contact your local Agilent customer center listed at the end of this manual or distributor.

System Installation for A27 Mass Storage
System Recovery (for serial prefix MY433 and later)

Step 6. The following screen appears. Select “+Removable Devices” with of the keyboard, and press of the keyboard.

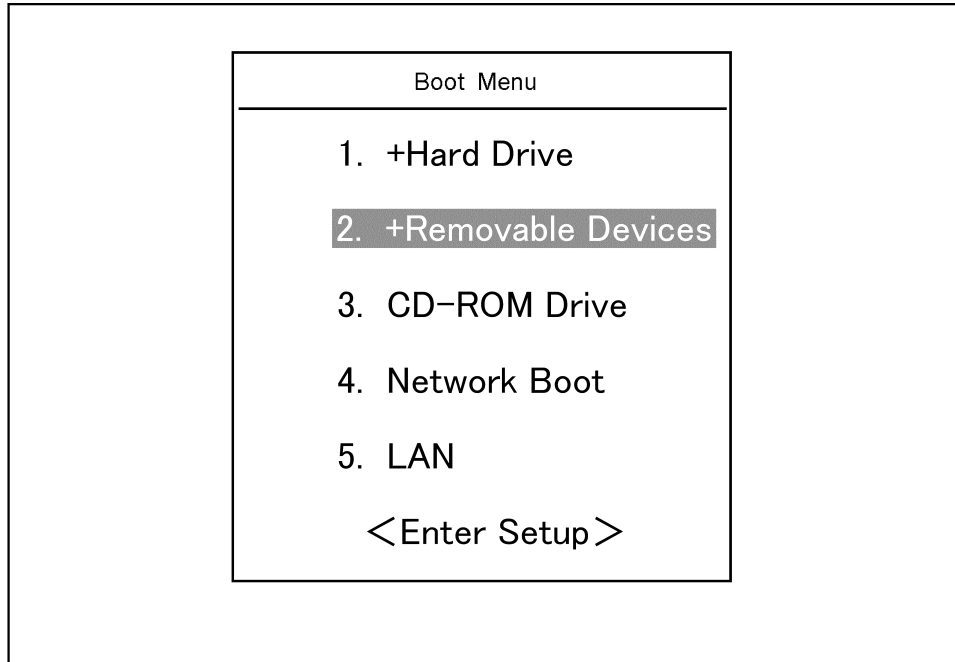

Step 7. The message as shown below appears. Press of the keyboard. If you want to cancel the create user backup image, press here.

```
Agilent Technologies System Utilities
Recovery & Backup Options
```

Choose One of the following:

-
1. Recover Factory Backup Image
 2. Create User Backup Image
 3. Recover User Backup Image
 4. Exit
-

Enter a Choice: _

NOTE

If the above message does not appear, the instrument or the disk for the system recovery is at fault; contact your local Agilent customer center listed at the end of this manual or distributor.

- Step 8.** The message as shown below appears. Press **C** of the keyboard. If you want to cancel the create user backup image, press **E** here.

You chose to create a backup image file of your system.

The system will perform a quick integrity check of the file structure on the C: Drive. It will then copy the C: partition to an image file and store it on the System Recovery partition.

Press C to Continue or E to Exit: _

- Step 9.** The message as shown below appears. Press **C** of the keyboard to start the create user backup image. If you want to cancel the create user backup image, press **E** here.

CAUTION! Interrupting this process may leave the system in an unstable state. Allow the software to complete the backup and recovery process. This may take up to 20 minutes depending on the system configuration.

Press C to Continue or E to Exit: _

CAUTION

Never turn off the power during the create user backup image because doing so may cause serious damage to the 4287A.

- Step 10.** The create user backup image will be complete in about 5 minutes. When the create user backup image is complete, the message as shown below appears. Press **Ctrl**, **Alt**, and **Delete** of the keyboard at the same time to restart.

Remove the disk and Press CLT+ALT+DEL to restart your system.

NOTE

If the above message does not appear, the instrument is at fault; contact your local Agilent customer center listed at the end of this manual or distributor.

Procedure to execute the user recovery function

Returns the contents of the C drive to a user-specified state. To use this function, you must create the user backup image in advance. For more information, see the description “Procedure to create the user backup image” on page 263.

NOTE This function is available when the volume label on the hard disk is IZ202 or higher.

NOTE You need the keyboard for this operation.

- Step 1.** Shut down the 4287A.
- Step 2.** Connect the keyboard to the 4287A.
- Step 3.** Insert the disk for the system recovery into the floppy disk drive of the 4287A.
- Step 4.** Press the standby switch of the 4287A to turn it on.
- Step 5.** When the screen as shown in the figure below appears, press and hold  of the keyboard until this screen disappears.

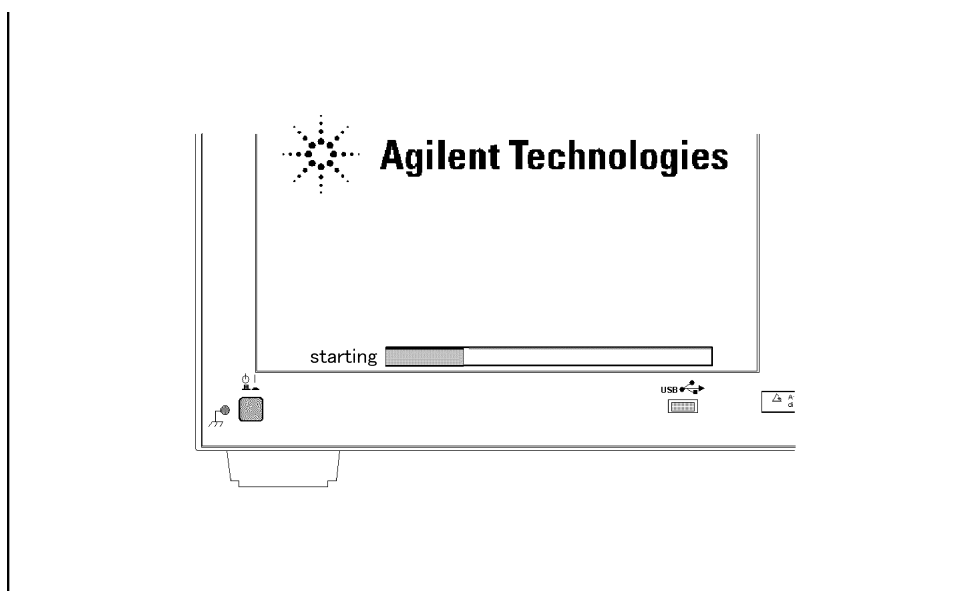

e5061buj034

NOTE After several seconds, the next screen appears automatically even if you do not press any key, so do not miss it.

If the above message does not appear, the instrument is at fault; contact your local Agilent customer center listed at the end of this manual or distributor.

Step 6. The following screen appears. Select “+Removable Devices” with of the keyboard, and press of the keyboard.

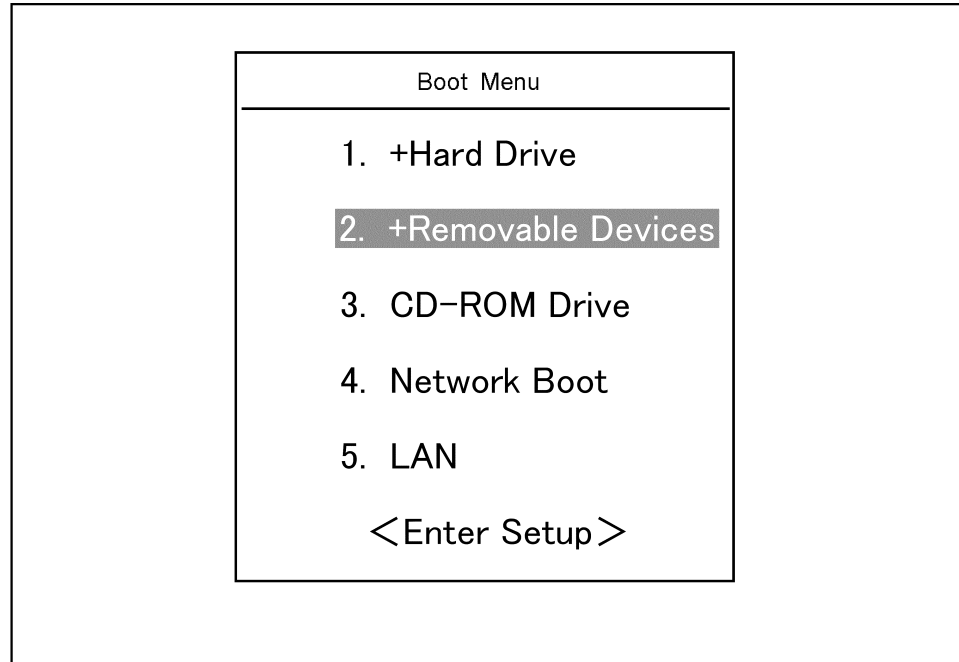

Step 7. The message as shown below appears. Press of the keyboard. If you want to cancel the user recovery, press here.

```
Agilent Technologies System Utilities
Recovery & Backup Options
```

```
Choose One of the following:
```

-
1. Recover Factory Backup Image
 2. Create User Backup Image
 3. Recover User Backup Image
 4. Exit
-

```
Enter a Choice: _
```

NOTE

If the above message does not appear, the instrument or the disk for the system recovery is at fault; contact your local Agilent customer center listed at the end of this manual or distributor.

System Installation for A27 Mass Storage
System Recovery (for serial prefix MY433 and later)

Step 8. The message as shown below appears. Press **C** of the keyboard. If you want to cancel the user recovery, press **E** here.

You chose to recover your own system backup image file.

WARNING: Press C to Continue only if you are sure that you want to proceed. The C: partition will be completely overwritten with no chance of recovering any data. Use Option 3 to recover the system from a serious malfunction caused by corrupted or inadvertently deleted files on the system's primary C: partition.

Press C to Continue or E to Exit: _

Step 9. The message as shown below appears. Press **C** of the keyboard to start the user recovery. If you want to cancel the user recovery, press **E** here.

CAUTION! Interrupting this process may leave the system in an unstable state. Allow the software to complete the backup and recovery process. This may take up to 20 minutes depending on the system configuration.

Press C to Continue or E to Exit: _

CAUTION

Never turn off the power during the system recovery because doing so may cause serious damage to the 4287A.

Step 10. The user recovery will be complete in about 5 minutes. When the user recovery is complete, the message as shown below appears. Press **Ctrl**, **Alt**, and **Delete** of the keyboard at the same time to restart.

Remove the disk and Press CLT+ALT+DEL to restart your system.

NOTE

If the above message does not appear, the instrument is at fault; contact your local Agilent customer center listed at the end of this manual or distributor.

Initial Registration of 4287A (for serial prefix MY433 and later)

When you start up the 4287A for the first time or after executing system recovery, you need to perform the initial registration of the Windows 2000 operating system of the 4287A.

NOTE

You cannot use the front panel keys during the initial registration of the 4287A therefore connect the mouse and the keyboard before turning on the power.

NOTE

If you perform the following procedure incorrectly, a message asking you whether to return to the previous registration screen and perform the registration appears. In this case, follow the instruction to return to the previous registration screen.

- Step 1.** Turns on the 4287A.
- Step 2.** The Windows 2000 Professional Setup wizard appears. Click the **Next >** button (Figure B-18).

Figure B-18

Windows 2000 Professional Setup wizard

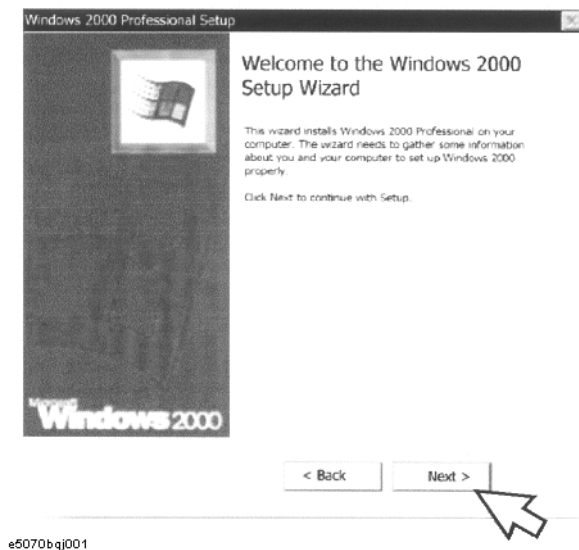

System Installation for A27 Mass Storage
Initial Registration of 4287A (for serial prefix MY433 and later)

Step 3. In the Windows 2000 Professional Setup dialog box, select the **I accept this agreement** box and click the **Next >** button (Figure B-19). Then, the Windows 2000 operating system is restarted automatically.

Figure B-19 Windows 2000 Professional Setup dialog box

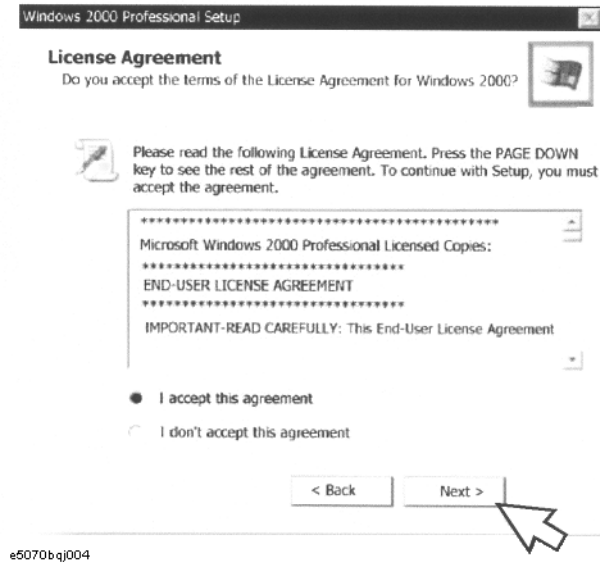

Step 4. The Network Identification wizard appears. Click the **Next >** button (Figure B-20).

Figure B-20 Network Identification wizard

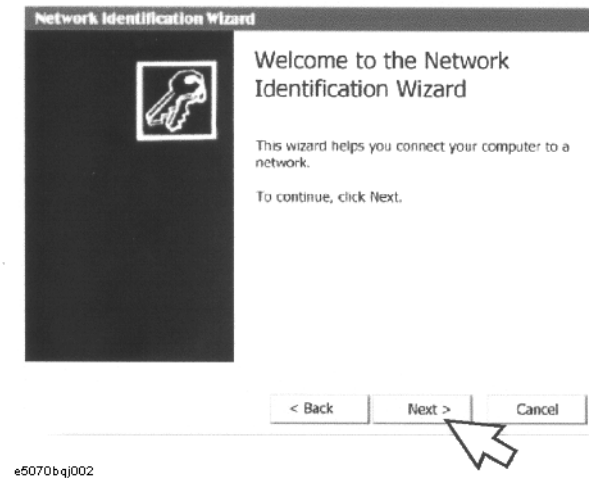

- Step 5.** In the Network Identification Wizard dialog box (1/2), select the **Windows always assumes the following user has logged on to this computer** box and check that **agt_instr** is in the **User Name** box. If not, type in **agt_instr**. Finally, click the **Next>** button (Figure B-21).

Figure B-21 Network Identification Wizard dialog box (1/2)

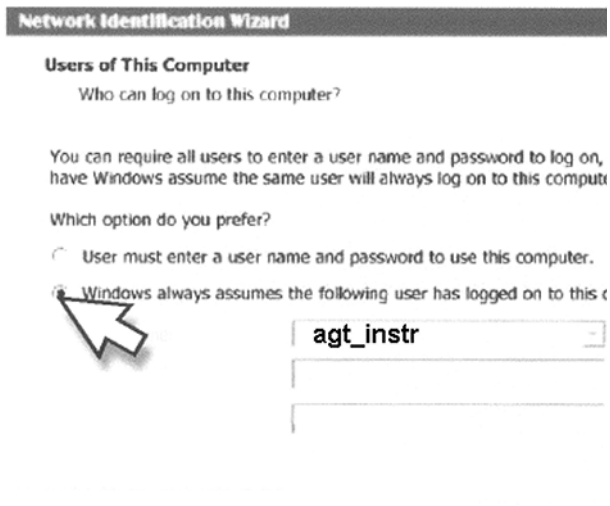

- Step 6.** In the Network Identification Wizard dialog box (2/2), click the **Finish** button to finish the initial registration of the 4287A (Figure B-22). Then, the measurement display of the 4287A appears.

Figure B-22 Network Identification Wizard dialog box (2/2)

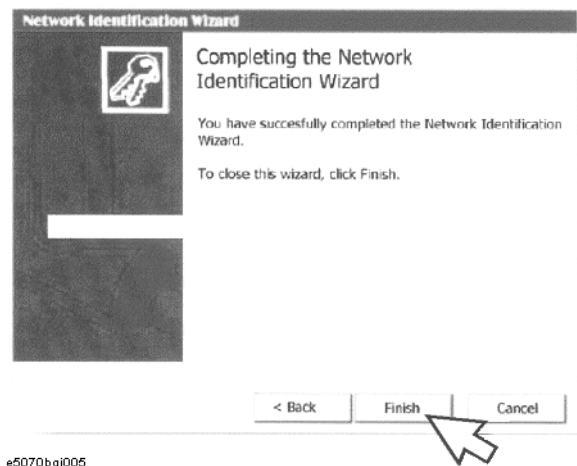

System Installation for A27 Mass Storage
Initial Registration of 4287A (for serial prefix MY433 and later)

C **Firmware Installation**

This appendix describes how to install the 4287A firmware. When you want to install or update the 4287A firmware, refer to this appendix.

Firmware Installation

Required Parts

- The 4287A Firmware Installation Disks

The latest firmware is downloadable from CTU-Kobe Web site. Prepare three floppy disks, and copy the firmware to them. If you can not download it, the firmware upgrade kit is available which consists of the firmware disks and the installation manual.

How to install the 4287A firmware

Step 1. Connect the mouse and the keyboard to the 4287A rear panel. Then turn the 4287A on.

Step 2. Change the 4287A mode to the Service Mode by the following procedure.

Press **[System]** key on the 4287A front panel, and press **SERVICE MENU, MISC MENU, SHUTDOWN AS SERVICE** softkeys. Then Figure C-1 will be displayed.

Figure C-1

Change the 4287A mode

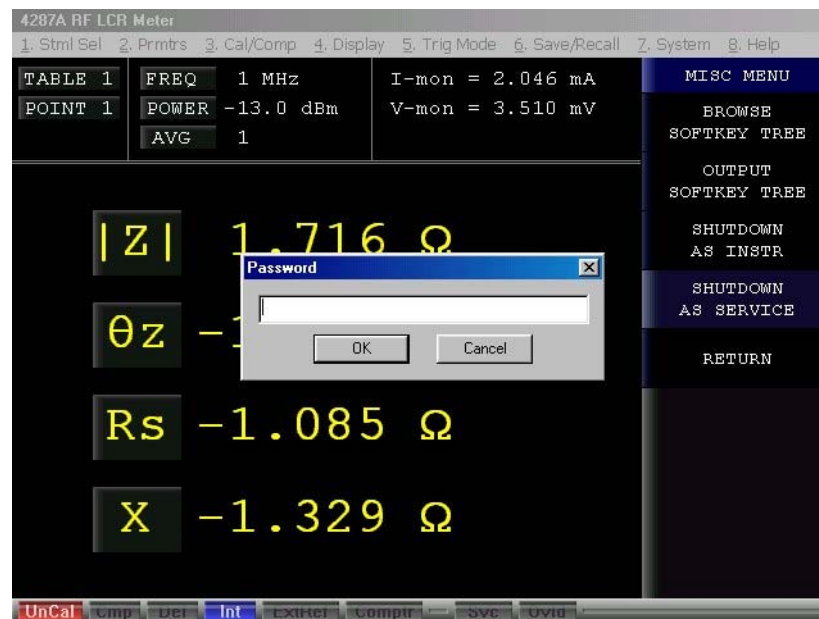

Step 3. Enter password as “kid”, then click **OK**. The 4287A will shutdown automatically.

Step 4. Turn the 4287A on, then the Figure 8-1 Windows desktop screen will be displayed.

Figure 8-1 Windows 98 desktop screen



Step 5. Double-click the “My Computer” icon on the Windows desktop.

Step 6. Next, insert the 4287A firmware installation disk1 (1 of 3) into the FDD of the 4287A.

Step 7. Then double-click the “3 1/2 Floppy [A:]” icon, Figure 8-2 will be displayed.

Figure 8-2 Windows desktop



Firmware Installation Firmware Installation

Step 8. Double-Click “Setup.exe” icon. Firmware installation will start automatically, and Figure 8-3 will be displayed.

Figure 8-3 Installation Screen 1



Step 9. After the disk1 installation is finished, Figure 8-4 will be displayed. Insert the disk2 (2 of 3) into the FDD of the 4287A, then click **OK**.

Figure 8-4 Installation Screen 2

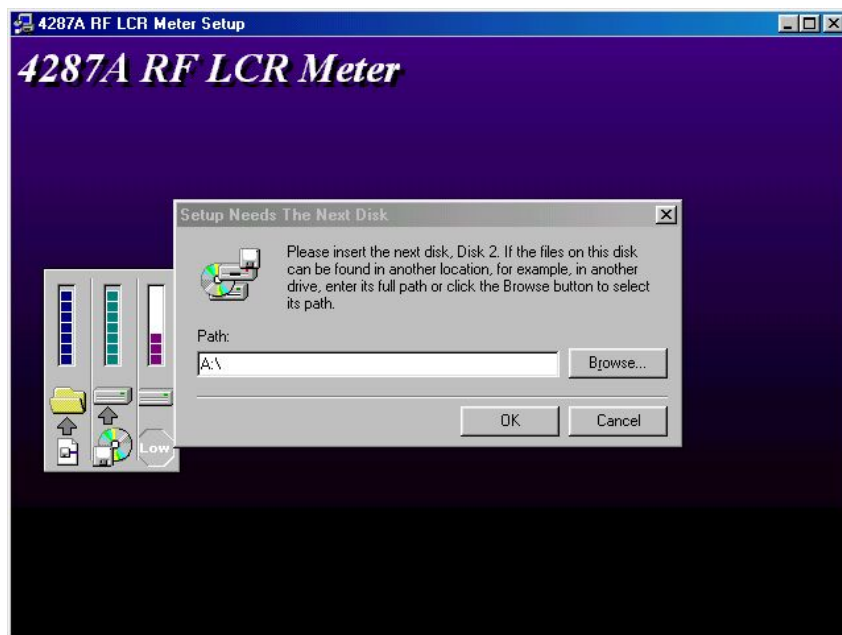

- Step 10.** After the disk2 installation is finished, Figure 8-5 will be displayed. Insert the disk3 (3 of 3) into the FDD of the 4287A, then click **OK**.

Figure 8-5 Installation Screen 3

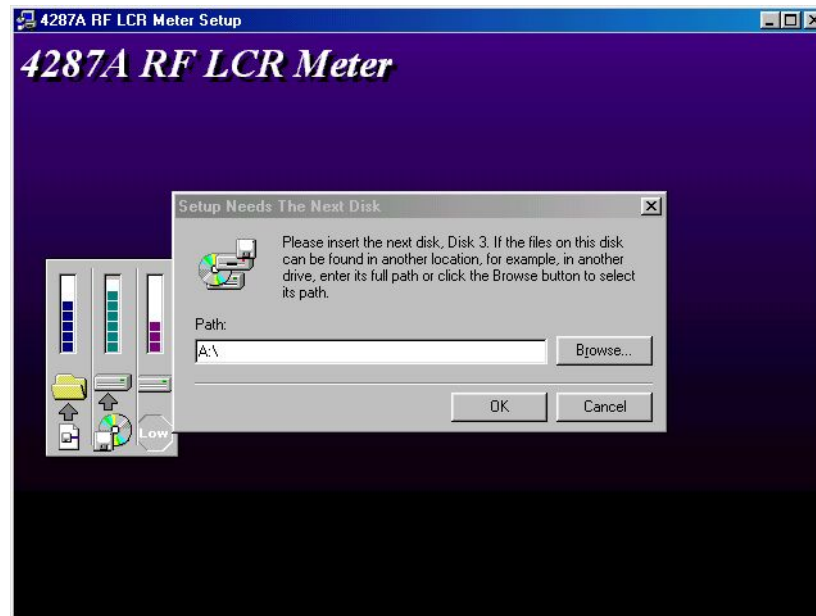

- Step 11.** After the disk3 installation is finished, the 4287A will shutdown automatically.
- Step 12.** Turn the 4287A on, then Windows desktop screen will be displayed.
- Step 13.** Double-click "4287A RF LCR Meter" icon on the windows desktop, the 4287A instrument screen will be displayed.
- Step 14.** Change the 4287A mode to the Instrument Mode by the following procedure.
Press [**System**] key on the 4287A front panel, and press **SERVICE MENU**, **MISC MENU**, **SHUTDOWN AS INSTR** softkeys. Then Figure C-1 will be displayed.
- Step 15.** Enter password "kid", then click **OK**. The 4287A will shutdown automatically.
- Step 16.** Turn the 4287A on, then the 4287A instrument screen will be displayed.

Firmware Installation
Firmware Installation

D Back-up User Files in A27 Mass Storage

This appendix describes how to back-up the user files which is saved in the A27 mass storage. Back-up the user files before the replacement or the system installation, if possible.

Back-up Files

Before the replacement or the system installation for the A27 mass storage, user files on the old A27 mass storage unit have to be copied to another media. Copy the files to floppy disks or other network drive via LAN.

Required Parts

- Floppy Disk
- Or,
- Personal Computer with LAN interface

How to Back-up the 4287A Files

The files should be copied to the floppy disk.

Step 1. Connect the mouse and the keyboard to the 4287A rear panel. Then turn the 4287A on.

Step 2. Change the 4287A mode from the Instrument mode to the Service mode by the following procedure.

Press **[System]** key on the 4287A front panel, and press **SERVICE MENU, MISC MENU, SHUTDOWN AS SERVICE** softkeys. Then, you are required the password.

Step 3. Enter password as “kid”, and click **OK**. Then, the 4287A will shutdown automatically.

Step 4. Turn the 4287A on again, then Windows desktop screen will be displayed.

Step 5. The 4287A prepares the user data area under the 4287A D drive. When it is able to back-up the user files to floppy disk, back-up them using Windows Explorer of the 4287A. When user file size is bigger than floppy disk capacity and it is unable to back-up it to floppy disk unfortunately, it is recommended to back-up them to specified drive on your personal computer via LAN. For details of LAN setting, refer to the operation manual.

E **Power Requirement**

Preparation for Power Supply

Before turning on power to the equipment, be sure to verify the following:

Power Requirements

The 4287A requires the following power source:

	Requirements
Voltage	90 to 132 VAC or 198 to 264 VAC *1
Frequency	47 to 63 Hz
Maximum power consumption	350 VA

*1. Switched automatically by the 4287A in conformity to the voltage.

Power Cable



In accordance with international safety standards, this instrument is equipped with a three-wire power cable. When connected to an appropriate ac power outlet, this cable grounds the instrument frame. The type of power cable shipped with each instrument depends on country of destination. Refer to Figure E-1 for the part numbers of the power cables available.

WARNING

For protection from electrical shock, the power cable ground must not be defeated.

The power plug must be plugged into an outlet that provides a protective earth ground connection.

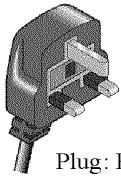
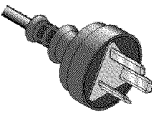
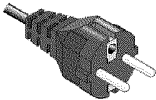
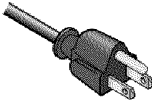
Figure E-1 Power cable options

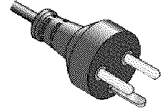
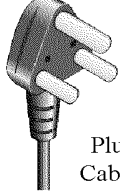
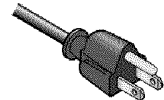
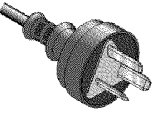
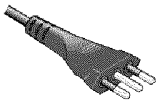
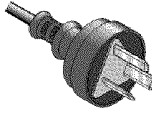
<p>OPTION 900</p>  <p>United Kingdom</p> <p>Plug: BS 1363/A, 250V, 10A Cable: 8120-1351, 8120-8705</p>	<p>OPTION 901</p>  <p>Australia/New Zealand</p> <p>Plug: AS 3112, 250V, 10A Cable: 8120-1369</p>
<p>OPTION 902</p>  <p>Continental Europe</p> <p>Plug: CEE 7 Standard Sheet VII, 250V, 10A Cable: 8120-1689</p>	<p>OPTION 903</p>  <p>U.S./Canada</p> <p>Plug: NEMA 5-15P, 125V, 10A Cable: 8120-1378</p>
<p>OPTION 904</p>  <p>U.S./Canada</p> <p>Plug: NEMA 6-15P, 250V, 6A Cable: 8120-0698</p>	<p>OPTION 906</p>  <p>Switzerland</p> <p>Plug: SEV Type 12, 250V, 10A Cable: 8120-2104</p>
<p>OPTION 912</p>  <p>Denmark</p> <p>Plug: SR 107-2-D, 250V, 10A Cable: 8120-2956</p>	<p>OPTION 917</p>  <p>India/Republic of S. Africa</p> <p>Plug: IEC 83-B1, 250V, 10A Cable: 8120-4211</p>
<p>OPTION 918</p>  <p>Japan</p> <p>Plug: JIS C 8303, 125V, 12A Cable: 8120-4753</p>	<p>OPTION 920</p>  <p>Argentina</p> <p>Plug: Argentine Resolution 63, Annex IV, 250V, 10A Cable: 8120-6870</p>
<p>OPTION 921</p>  <p>Chile</p> <p>Plug: CEI 23-16, 250V, 10A Cable: 8120-6978</p>	<p>OPTION 922</p>  <p>China</p> <p>Plug: GB 1002, 250V, 10A Cable: 8120-8376</p>
<p>NOTE: Each option number includes a 'family' of cords and connectors of various materials and plug body configurations (straight, 90° etc.).</p>	

power_e

Turning the Power ON and OFF

Perform the following steps to turn the power ON or OFF.

Turning the power ON

- Step 1.** If the standby switch (⏻) in the lower-left part of the front panel is in the pressed down (⏻) position, press the switch to the popped up position (⏻).
- Step 2.** Press the standby switch to the pressed down position (⏻).
This operation turns ON the power, and the 4287A starts the self-test.
- Step 3.** Confirm that the self-test indicates normal operation.
Normal operation is confirmed by the self-test if no error message appears.

Turning the power OFF

- Step 1.** Use either of the following methods to turn OFF the 4287A.
- Press the standby switch (⏻) in the lower-left part of the front panel (now in the pressed down (⏻) position) to the popped up (⏻) position.
 - Send the shutdown command from an external controller.

These operations will start the 4287A shutdown process (required software and hardware processes for turning the power off), and the power will turn OFF after a few seconds.

NOTE

Under normal circumstances, always press the standby switch (⏻), or send the shutdown command from the external controller, to actuate the 4287A shutdown process. **Never cut off the power supply directly by disconnecting the power cable plug from the rear panel of the unit.**

If the power supply is cut off directly by disconnecting the power cable plug or by disconnecting the power supply to the AC outlet, the shutdown process will not be carried out, and there is a risk of damage to the software or hardware of the 4287A.

F Error Messages

The Agilent 4287A provides error messages to indicate its operating status. This appendix describes the error messages of the 4287A in order of error number. To search error messages alphabetically, refer to the *Operation Manual*.

Error Messages

Error number: No number

Error messages are displayed at the top of the 4287A's LCD. Error messages generated during the execution of a GPIB command are preceded by the string "[GPIB]" or "[TELNET]" and can be read out using the GPIB command. This section describes each error message and its remedy.

You can clear error messages displayed on the screen using the following commands.

- **:DISP:CCL**

NOTE

Errors with a negative error number are basically general errors defined by IEEE488.2 for GPIB instruments. On the other hand, errors with a positive error number are defined specifically for the 4287A.

Order of error number

No number

A21 board can't be detected. The instrument will be automatically shutdown in 20 seconds.

The A21 board cannot be detected.

The 4287A will be automatically shut down in approximately 20 seconds after the occurrence of this error. The 4287A is at fault and needs repair.

Contact the Agilent Technologies sales office or the company you purchased this instrument.

NOTE

This is a special error that occurs at the startup of the 4287A. The error message, unlike other ones, is displayed in the box that appears at the center of the LCD display, instead of the top of it. No error number is assigned.

No number

A24 GPIB board can't detected. Press OK to continue.

The A24 board cannot be detected.

Although the measurement screen appears normally, the instrument has started up abnormally (GPIB is disabled). To recover the normal status, reboot the 4287A (turn OFF the standby switch and then ON again).

If this error persists after rebooting the 4287A, or occurs frequently, the 4287A is at fault and needs repair. Contact the Agilent Technologies sales office or the company you purchased this instrument.

NOTE

This is a special error that occurs at the startup of the 4287A. The error message, unlike other ones, is displayed in the box that appears at the center of the LCD display, instead of the top of it. No error number is assigned.

- 0 **(No error)**
No error has occurred.
This message is not displayed on the LCD. 0 is returned as the error number if no error has occurred in the instrument when the `:SYST:ERR?` is sent through GPIB.
- 6 **Additional standards needed**
Before the completion of all data measurements required for calculating the calibration/compensation coefficients, a GPIB command requiring some part of the measurement data is sent. For example, when only the OPEN and SHORT measurements of the calibration kit have been complete, the `:CORR1:COLL:SAVE` which performs calculation of the calibration coefficients, is sent.
Measure all of the required data.
- 7 **Calibration required**
Although the calibration is not turned on, a GPIB command is sent that is valid only when the calibration is turned on. For example, the `:CORR2:COLL`, which obtains the data for calculating the compensation coefficients, is executed.
Turn on the calibration.
- 11 **Compensation required**
Although compensation is not turned on, a GPIB command is sent that is valid only when compensation is turned on. For example, the `:DATA:CMP{1-3}`, which reads out the compensation coefficients, is executed when compensation is turned off.
Turn on the compensation.
- 22 **Printer error**
The printer does not respond to control from the 4287A.
Check the power to the printer, cable connections, paper, and so on.
- 61 **No data available on memory**
Although the data for statistical analysis has not been acquired, the `:CALC:EXAM:GET?`, which executes statistical analysis and acquires the results, is sent.
Acquire the data for statistical analysis.
- 62 **Can't execute data examination**
The data for statistical analysis has been acquired, but change is made to the settings during data acquisition, and thus statistical analysis cannot be executed.
Acquire the data for statistical analysis with the current settings.

Error Messages

Error number: 104

104

Save error

When saving a file, anomalies in the storage media are detected. For example, when you attempt to save a file on a floppy disk, there is not enough space on the disk.

Make sure there is enough space on the floppy disk.

105

Recall error

An error occurs while reading out (recalling) a file. For example, you attempt to read out a file with invalid contents (such as an instrument setting file with extension “.sta”, which is saved by using an instrument other than the 4287A).

Make sure that the contents of the file are valid.

106

Invalid File Name

When executing the save/recall file command, a file name string is invalid. For example, when executing the save command, no extension for the file is specified.

Specify a valid file name.

This error also occurs if the floppy disk has not been correctly set into the drive or if the disk is write-protected when you attempt to save a file onto the disk.

120

PLL unlock

Phase lock loop is not locked

When you enter the external reference signal, check to make sure it is correct. If you entered the correct signal or you did not enter any signal, the instrument needs adjustment or repair. Contact your local Agilent Technologies sales office or the company you purchased this instrument from.

198

Power on test failed

In the power-on self test, a fault is detected.

Contact your local Agilent Technologies sales office or the company you purchased this instrument from.

- 100 **Command error**
A comprehensive syntax error occurs for which the 4287A cannot detect further details of the error. This error code simply indicates the occurrence of a command error that is defined in IEEE488.2,11.5.1.1.4.
- 101 **Invalid character**
Invalid characters exist in the program message string. For example, in a correct program message “:CALC:PAR1:FORM LS”, an ampersand (&) is inserted by mistake to give “:CALC:PAR1:FORM&LS”.
- 102 **Syntax error**
There is a command or data type that cannot be recognized. For example, in a correct program message “:SYST:PRES”, a colon (:) is inserted by mistake to give “:SYST::PRES”.
- 103 **Invalid separator**
The parser (syntax analysis program) expects a separator, but a character other than a separator is sent. For example, although the correct way is to use “;” to separate two sent program messages such as “:CALC:PAR1:FORM LS;*OPC?”, the semicolon (;) needed to separate the program messages is missing to give “:CALC:PAR1:FORM LS *OPC?”.
- 104 **Data type error**
The parser recognized impossible data elements. For example, numeric value or string data is expected, but block data is sent.
- 105 **GET not allowed**
A group execution trigger (GET) is received in a program message. (Refer to IEEE488.2,7.7.)
- 108 **Parameter not allowed**
The number of parameters is larger than required by the command. For example, although the :SOUR:LIST:TABL requires one parameter such as “:SOUR:LIST:TABL 3”, two parameters are added to give “:SOUR:LIST:TABL 3,5”.
- 109 **Missing parameter**
The number of parameters is less than required by the command. For example, although the :SOUR:LIST:TABL requires one parameter such as “:SOUR:LIST:TABL 3”, no parameter is added to give “:SOUR:LIST:TABL”.
- 112 **Program mnemonic too long**
The length of the header exceeds 12 characters. (Refer to IEEE488.2,7.6.1.4.1.)
- 113 **Undefined header**
A header not defined for the 4287A is received. For example, “*XYZ”, which is not defined for the 4287A, is received.
- 120 **Numeric data error**
Numeric data (including numeric data without a decimal point) causes an error. A numeric value error other than -121 to -129 occurs.

Error Messages

Error number: -121

- 121 **Invalid character in number**
An invalid character for the data type of the syntax analysis target is received. For example, alphabetical characters exist in a decimal value or “9” exists in octal data.
- 123 **Exponent too large**
The absolute value of the exponent exceeds 32,000. (Refer to IEEE488.2,7.7.2.4.1.)
- 124 **Too many digits**
The number of digits of the mantissa of the decimal value data element exceeds 255 except for preceding 0s. (Refer to IEEE488.2,7.7.2.4.1.)
- 128 **Numeric data not allowed**
A numeric value data element (that does not violate the standard) is received where the 4287A does not accept any numeric value data element.
- 131 **Invalid suffix**
The suffix does not meet the syntax defined in IEEE488.2,7.7.3.2 or is inappropriate for the 4287A.
- 134 **Suffix too long**
The suffix contains notation of 12 characters or more. (Refer to IEEE488.2,7.7.3.4.)
- 138 **Suffix not allowed**
A suffix is added to a numeric value element that does not permit a suffix.
- 148 **Character data not allowed**
A character data element (that does not violate the standard) is received where the 4287A does not accept any character data element.
- 150 **String data error**
An error not included in error numbers between -151 and -159 occurs during the syntax analysis of a string data element.
- 151 **Invalid string data**
Character string data are expected, but the string data received are invalid for some reason. (Refer to IEEE488.2,7.7.5.2.) For example, the END message is received before the end quotation mark character appears.
- 158 **String data not allowed**
A string data element is received where the 4287A does not accept any string data element. For example, a parameter must be enclosed with double quotation marks (“...”) but they are missing.
- 161 **Invalid block data**
Block data are expected, but the block data received are invalid for some reason. (Refer to IEEE488.2,7.7.6.2.) For example, the END message is received before the length of the block data is reached.
- 168 **Block data not allowed**
A block data element is received where the 4287A does not accept any block data element.

- 170 **Expression error**
An error not included in error numbers between -171 and -179 occurs during the syntax analysis of equation data.
- 171 **Invalid expression**
The equation data element is invalid. (Refer to IEEE488.2,7.7.7.2.) For example, parentheses are not paired or a character violates the standard.
- 178 **Expression data not allowed**
An equation data element is received where the 4287A does not accept any equation data element.
- 200 **Execution error**
A comprehensive execution error occurs for which the 4287A cannot detect further details of the error. This error code simply indicates the occurrence of an execution error that is defined in IEEE488.2,11.5.1.1.5.
- 211 **Trigger ignored**
A trigger command or trigger signal is received and recognized by the 4287A, but it is ignored due to the timing relationship with the 4287A. For example, this happens when the 4287A's trigger system is not in the Waiting for Trigger state).
- 213 **Init ignored**
Another measurement is being executed and the measurement start request (: INIT) is ignored.
- 221 **Setting conflict**
A program data element complying with the syntax standard is analyzed, but the 4287A cannot execute it at present.
- 222 **Data out of range**
A data element (that does not violate the standard) is received out of the range defined for the 4287A.
- 223 **Too much data**
The received block, equation, or string type program data complies with the standard but the amount of data exceeds the limit that the 4287A can handle due to memory or device-specific conditions related to memory.
- 224 **Illegal parameter value**
The value of the parameter is not allowed.
- 230 **Data corrupt or stale**
The data is invalid or a newly initiated read operation has not been completed since the latest access.
- 256 **File name not found**
The specified filename is not found and, as a result, the command is not executed correctly. For example, this happens when you attempt to read a file that does not exist on the disk.

This message is also displayed when you attempt to read a file on floppy disk drive, but no floppy disk is correctly inserted in the drive.

Error Messages
Error number: -310

- 310 **System error**
One of the “system errors” defined for the 4287A occurs.
- 321 **Out of memory**
An internal operation needed more memory than is available.
- 400 **Query error**
A comprehensive Query error occurs for which the 4287A cannot detect further details. This code simply indicates the occurrence of a Query error that is defined in IEEE488.2,11.5.1.1.7 and 6.3.
- 410 **Query INTERRUPTED**
This indicates the status that causes an “INTERRUPTED” Query error. (Refer to IEEE488.1,6.3.2.3.) This error occurs, for example, when data byte (DAB) or GET is received after Query but before the response has been completely sent.
- 420 **Query UNTERMINATED**
This indicates the status that causes an “UNTERMINATED” Query error. (Refer to IEEE488.2,6.3.2.) This error occurs, for example, when the 4287A is specified as a talker and an incomplete program message is received.
- 430 **Query DEADLOCKED**
This indicates the status that causes a “DEADLOCKED” Query error. (Refer to IEEE488.2,6.3.1.7.) This error occurs, for example, when both input and output buffers become full and the 4287A cannot continue processing.
- 440 **Query UNTERMINATED after indefinite response**
In a certain program message, after a Query that requests an ambiguous response is executed, another Query is received. (Refer to IEEE488.2,6.5.7.5.7.)

REGIONAL SALES AND SUPPORT OFFICES

For more information about Agilent Technologies test and measurement products, applications, services, and for a current sales office listing, visit our web site: <http://www.agilent.com/find/tmdir>. You can also contact one of the following centers and ask for a test and measurement sales representative. 21/01/2004

United States:

Test and Measurement Call Center
(tel) 1 800 452-4844
(fax) 1 888 900-8921

Australia/New Zealand:

(tel) (61 3) 9210-5555 (Australia)
(fax) (61 3) 9210-5899
(tel) (64 4) 939-0636 (New Zealand)
(fax) (64 4) 972-5364

Canada:

Test and Measurement Call Center
(tel) 1 877 894-4414
(fax) 1 888 900-8921

Asia Pacific:

(tel) (65) 6375-8100
(fax) (65) 6836-0252
Email: tm_asia@agilent.com

China:

(tel) 800 810-0189
(fax) 800 820-2816

Europe:

(tel) (31 20) 547-2323
(fax) (31 20) 547-2390

Japan:

Call Center
(tel) 0120 421-345
(tel) (81) 426 56-7832
(fax) (81) 426 56-7840

Korea:

(tel) (82 2) 2004-5004
(fax) (82 2) 2004-5115

Latin America:

(tel) (305) 269-7500
(fax) (305) 269-7599

Taiwan:

(tel) 0800 047 866
(fax) 0800 286 331